

June 2022 - CA



***Cleaning Products
For Professionals
Produits de nettoyage
pour professionnels***

Now Shipping Around the World.



When buying Canadian, rest assured that the products are subject to rigorous health and safety standards.

We have over 40 years of experience, manufacturing a wide range of products to service the entire Janitorial, Sanitation & Industrial markets.

















We stock our entire product line in our 90,000 sq. ft. facility, to ensure quick delivery and great customer service.

Gabriel Marino

Gabriel Marino



INDEX

	Buckets & Wringers / Seaux &essoreuses Janitor Carts, Utility Carts, Pails, Caution Signs Chariot de ménage, chariot utilitaire, seaux, panneaux d'avertissement.....	2
	Waste Management / Gestion des déchets Waste Containers, Litter Scoop, Lobby Dust Pans Contenants à déchets, pelles à litière, promenoir-poussoir.....	16
	Magnetic, Angle and Corn Brooms / Balais magnétique, en angle, de maïs Venus, Pluto, Cupid, Hercules, Track Brooms Venus, Pluto, Cupid, Hercules, balais ferroviaires.....	25
	Brushes / Brosses Carpet, Utility Deck, Hand Scrubs, Pot, Counter, Window, Masonry, Wire, Scrubs and Specialty Tapis, de pont utilitaire, à main, à casseroles, de comptoir, à vitres, de maçonnerie, à fils d'acier, de récurage et utilitaires.....	31
	Push Brooms / Balais-poussoir Ryno, Fine, Medium and Coarse Sweep, Handles Ryno, Brins fins, moyens, grossiers et manches.....	38
	Floor Squeegees / Raclettes à plancher Moss Floor Squeegee, Metal Racloir à plancher "Moss", métal.....	50
	Wet Mops / Vadrouilles humides Super Looper, Swinger, Swipe, Microfiber, Synray, Cotton Yacht and Specialty Super Looper, Swinger, Swipe, microfibre, Synray, Yacht en coton et spécialité.....	54
	Wet Mop Handles / Manches de vadrouilles humides Step-N-Go, Quick Change and Jaw Style Step-N-Go, changement rapide, style mâchoire.....	75
	Dust Mops / Vadrouilles à poussière Static-H, M-Tech, G-Stat, Micro-PET, Static-A, Cotton and Handles Static-H, M-Tech, G-Stat, Micro-Pet, Static-A, Coton, et les Manches.....	77
	Wall Washing / Lavage des murs Doodle Bug, Dusters Doodle Bug, lavette.....	85
	Washroom Care / Entretien des salles d'eau Trigger Sprayers, Bottles, Jugs, Air Deodorizers, Soap Dispensers, Brushes, Urinal, Pulvérisateur à gachette, bouteilles, bidons, purificateur d'air, distributeur de savon, brosses, tamis d'urinoir.....	89
	Wiping / Essuyage Microfiber Cloths, Sponges and Scouring Pads Chiffons microfibre, éponges, tampons à récurer.....	97
	Window Cleaning / Lavage des fenêtres Handles, T-Bar, Sleeves, Tool Holders, Buckets Poignées, Lames en caoutchouc, support en T, Rechanges, porte-outils, seau à vitres.....	103
	Flat Mopping / Tampons plats Slide & Lock, MicroPad, Olympic Frame, Moppads, Buckets & Wringers Slide & Lock, tampons microfibre, chassis Olympic, tampons, seaux etessoreuses.....	110
	Food Foodservice / Industrie de l'alimentation Foodservice Pushbrooms, Food Processing (HACCP) Balais-poussoir d'alimentation, transformation des aliments (HACCP).....	126
	M2 Retail / M2 vente au détail Magnetic Brooms, Corn Brooms, Detachable Mops & Buckets, Dish Brushes Balais Magnétiques, Balais De Maïs, Vadrouilles et seaux détachables, Brosse à vaisselle.....	139

THE ELEPHANT FOOT/ LE SYSTÈME PIED D'ÉLÉPHANT

ELEPHANT FOOT COMBOS

- Professional grade mop bucket ideal for the toughest and largest messes
- High grade polypropylene construction prevents corrosion and cracking
- Easy pour spout makes it easy to clean and store
- 3" non-marking casters make it easy to maneuver on any surface and prevents scuffs
- Designed to accommodate any Down Press, Side Press and roller wringer
- High grade polypro Down Press wringer can support a variety of mop sizes
- Reinforced gears improve lifespan of wringer compared to low quality imports

- Seau à vadrouille de qualité professionnelle idéal pour les gros dégâts.
- La construction de polypropylène à haute teneur empêche la corrosion et la fissuration.
- Le bec verseur facile le rend facile à nettoyer et à ranger
- Les roulettes non marquantes de 3" facilitent la manoeuvre sur toutes les surfaces et évitent les éraflures.
- Conçu pour accommoder toutes les essoreuses à pression latérale, descendante ou à rouleau.
- L'essoreuse à pression descendante peut supporter une variété de tailles de vadrouille.
- Les engrenages renforcés améliorent la durée de vie de l'essoreuse par rapport aux importations de faible qualité.



M2 Code Code M2	Description	Pack Wt LB (S) Poids (lb) (S)	Pack Wt KG Poids (kg)	Cubic Ft Pi3	Pack Contenu	List Price Liste des prix
BW-D41100 - GN	40 Qt./37L Down Press Elephant Foot Combo - Green / Ensemble d'essoreuse descendante Éléphant, 40 ptes - vert	18.2	8.25	3.58	1	\$ 217.49
BW-D41100 - BL	40 Qt./37L Down Press Elephant Foot Combo - Blue / Ensemble d'essoreuse descendante Éléphant, 40 ptes - bleu	18.2	8.25	3.58	1	\$ 217.49
BW-D41100 - RD	40 Qt./37L Down Press Elephant Foot Combo Red/ Ensemble d'essoreuse descendante Éléphant, 40 ptes - rouge	18.2	8.25	3.58	1	\$ 217.49
BW-D41100 - YE	40 Qt./37L Down Press Elephant Foot Combo - Yellow / Ensemble d'essoreuse descendante Éléphant, 40 ptes - jaune	18.2	8.25	3.58	1	\$ 217.49
BW-D41100 - GY	40 Qt./37L Down Press Elephant Foot Combo Grey / Ensemble d'essoreuse descendante Éléphant, 40 ptes - Gris	18.2	8.25	3.58	1	\$ 217.49



1YEAR
Warranty On All Grizzly
& Elephant Foot Combos
Garanti D'un An Sur Les
Ensembles Grizzly Et
Éléphant

GRIZZLY / LE SYSTÈME GRIZZLY

GRIZZLY DOWN PRESS COMBOS

- High grade polypropylene construction prevents corrosion and cracking
- 3" non-marking casters make it easy to maneuver on any surface and prevents scuffs
- Designed to accommodate any Down Press, Side Press and roller wringer
- High grade polypro Down Press wringer can support a variety of mop sizes

- La construction de polypropylène à haute teneur empêche la corrosion et la fissuration.
- Les roulettes non marquantes de 3" facilitent la manoeuvre sur toutes les surfaces et évitent les éraflures.
- Conçu pour accommoder toutes lesessoreuses à pression latérale, descendante ou à rouleau.
- L'essoreuse à pression descendante peut supporter une variété de tailles de vadrouille.



M2 Code Code M2	Description	Pack Wt LB (S) Poids (lb) (S)	Pack Wt KG Poids (kg)	Cubic Ft Pi3	Pack Contenu	List Price Liste des prix
BW-D33100 - GN	32 Qt Grizzly Down Press Combo – Green / Ensembleseau-essoreuse descendante, 32 pte – vert	25	11.3	2.4	1	\$ 174.63
BW-D33100 - BL	32 Qt Grizzly Down Press Combo – Blue / Ensembleseau-essoreuse descendante, 32 pte – bleu	25	11.3	2.4	1	\$ 174.63
BW-D33100 - RD	32 Qt Grizzly Down Press Combo – Red / Ensembleseau-essoreuse descendante, 32 pte – rouge	25	11.3	2.4	1	\$ 174.63
BW-D33100 - YE	32 Qt Grizzly Down Press Combo – Yellow / Ensembleseau-essoreuse descendante, 32 pte – jaune	25	11.3	2.4	1	\$ 174.63
BW-D33100 - GY	32 Qt Grizzly Down Press Combo – Grey / Ensembleseau-essoreuse descendante, 32 pte – Gris	25	11.3	2.4	1	\$ 174.63

GRIZZLY SIDE PRESS COMBOS /



BW-S34100 - GN	32 Qt/30L Grizzly Side Press Combo – Green / Ensembleseauessoreuse latérale, 32 pte/30L – vert	25	11.3	2.4	1	\$ 168.69
BW-S34100 - BL	32 Qt/30L Grizzly Side Press Combo – Blue / Ensembleseauessoreuse latérale 32 pte/30L – bleu	25	11.3	2.4	1	\$ 168.69
BW-S34100 - RD	32 Qt/30L Grizzly Side Press Combo – Red / Ensembleseauessoreuse latérale 32 pte/30L – rouge	25	11.3	2.4	1	\$ 168.69
BW-S34100 - YE	32 Qt/30L Grizzly Side Press Combo – Yellow / Ensembleseauessoreuse latérale, 32 pte/30L – jaune	25	11.3	2.4	1	\$ 168.69
BW-S34100 - GY	32 Qt/30L Qt Grizzly Side Press Combo – Grey / Ensembleseauessoreuse latérale, 32 pte/30L – Gris	25	11.3	2.4	1	\$ 168.69



1 YEAR
 Warranty On All Grizzly
 & Elephant Foot Combos
 Garanti D'un An Sur Les
 Ensembles Grizzly Et
 Éléphant



40QT / 37L LARGE CHAMP DOWN PRESS BUCKETS & WRINGER COMBOS / SEAUX ET ESSOREUSES CHAMP 40QT / 37L

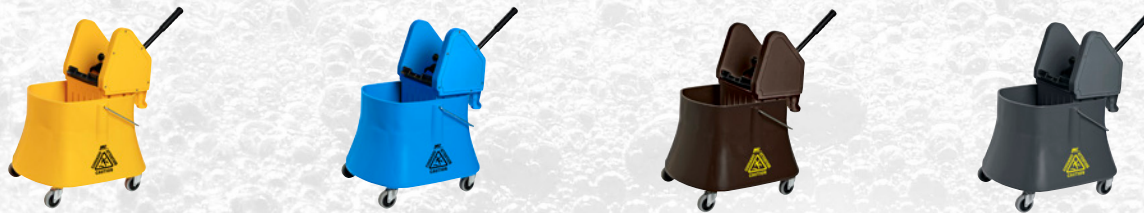

M2 Code Code M2	Description	Pack Wt LB (S) Poids (lb) (S)	Pack Wt KG Poids (kg)	Cubic Ft Pi3	Pack Contenu	List Price Liste des prix
BW-D1232-40 - YE	40 Qt./37L Champ Heavy Duty Down Press Combo - Large - Yellow	18.2	8.25	3.58	1	\$ 284.67
BW-D1232-40 - BL	40 Qt./37L Champ Heavy Duty Down Press Combo - Large - Blue	18.2	8.25	3.58	1	\$ 284.67
BW-D1232-40 - BR	40 Qt./37L Champ Heavy Duty Down Press Combo - Large - Brown	18.2	8.25	3.58	1	\$ 284.67
BW-D1232-40 - GY	40 Qt./37L Champ Heavy Duty Down Press Combo - Large - Grey	18.2	8.25	3.58	1	\$ 284.67

40QT / 37L LARGE CHAMP SIDE PRESS BUCKETS & WRINGER COMBOS / SEAUX ET ESSOREUSES CHAMP 40QT / 37L



BW-S1140 - YE	40 Qt./37L Champ Heavy Duty Side Press Combo - Large - Yellow	18.2	8.25	3.58	1	\$ 216.52
BW-S1140 - BL	40 Qt./37L Champ Heavy Duty Side Press Combo - Large - Blue	18.2	8.25	3.58	1	\$ 216.52
BW-S1140 - BR	40 Qt./37L Champ Heavy Duty Side Press Combo - Large - Brown	18.2	8.25	3.58	1	\$ 216.52
BW-S1140 - GY	40 Qt./37L Champ Heavy Duty Side Press Combo - Large - Grey	18.2	8.25	3.58	1	\$ 216.52

26-30 QT SMALL CHAMP DOWN PRESS BUCKETS & WRINGER COMBOS / SEAUX ET ESSOREUSES CHAMP 26-30 QT



BW-D2633 - YE	30 Qt./29L Junior Champ Down Press Combo - Yellow	25	11.3	2.4	1	\$ 203.47
BW-D2633 - BL	30 Qt./29L Junior Champ Down Press Combo - Blue	25	11.3	2.4	1	\$ 203.47
BW-D2633 - BR	30 Qt./29L Junior Champ Down Press Combo - Brown	25	11.3	2.4	1	\$ 203.47
BW-D2633 - GY	30 Qt./29L Junior Champ Down Press Combo - Grey	25	11.3	2.4	1	\$ 203.47

26-30 QT SMALL CHAMP SIDE PRESS BUCKETS & WRINGER COMBOS / SEAUX ET ESSOREUSES CHAMP 26-30 QT



BW-S1133 - YE	30 Qt./29L Junior Champ Heavy Duty Side Press Combo - Yellow	25	11.3	2.4	1	\$ 116.52
BW-S1133 - BL	30 Qt./29L Junior Champ Heavy Duty Side Press Combo - Blue	25	11.3	2.4	1	\$ 116.52
BW-S1133 - BR	30 Qt./29L Junior Champ Heavy Duty Side Press Combo - Brown	25	11.3	2.4	1	\$ 116.52
BW-S1133 - GY	30 Qt./29L Junior Champ Heavy Duty Side Press Combo - Grey	25	11.3	2.4	1	\$ 116.52

ELEPHANT FOOT BUCKET / SEAUX ÉLÉPHANT SUR PIED



M2 Code Code M2	Description	Pack Wt LB (S) Poids (lb) (S)	Pack Wt KG Poids (kg)	Cubic Ft Pi3	Pack Contenu	List Price Liste des prix
BW-D41102 - GN	40 Qt./37L Elephant Foot - Bucket Only - Green / Seau Éléphant, 40 ptes/37L- vert	10.6	4.8	2.40	1	\$ 114.25
BW-D41102 - BL	40 Qt./37L Elephant Foot - Bucket Only - Blue / Seau Éléphant, 40 ptes/37L- bleu	10.6	4.8	2.40	1	\$ 114.25
BW-D41102 - RD	40 Qt./37L Elephant Foot - Bucket Only - Red/ Seau Éléphant, 40 ptes/37L- rouge	10.6	4.8	2.40	1	\$ 114.25
BW-D41102 - YE	40 Qt./37L Elephant Foot - Bucket Only - Yellow / Seau Éléphant, 40 ptes/37L-jaune	10.6	4.8	2.40	1	\$ 114.25
BW-D41102 - GY	40 Qt./37L Elephant Foot - Bucket Only - Grey / Seau Éléphant, 40 ptes/37L- Gris	10.6	4.8	2.40	1	\$ 114.25

GRIZZLY BUCKET / SEAUX GRIZZLY



BW-S32102 - GN	32 Qt/30L Grizzly - Bucket Only - Green / Seau, 32 pte/30L - vert	7	3	2.4	1	\$ 82.33
BW-S32102 - BL	32 Qt/30L Grizzly - Bucket Only - Blue / Seau, 32 pte/30L - bleu	7	3	2.4	1	\$ 82.33
BW-S32102 - RD	32 Qt/30L Grizzly - Bucket Only - Red / Seau, 32 pte/30L - rouge	7	3	2.4	1	\$ 82.33
BW-S32102 - YE	32 Qt/30L Grizzly - Bucket Only - Yellow / Seau, 32 pte/30L - jaune	7	3	2.4	1	\$ 82.33
BW-S32102 - GY	32 Qt/30L Grizzly - Bucket Only - Grey / Seau, 32 pte/30L - Gris	7	3	2.4	1	\$ 82.33

40QT / 37L LARGE CHAMP BUCKETS /



BW-D2640 - YE	40 Qt./37L Champ Heavy Duty - Bucket Only - Yellow	18.2	8.25	3.58	1	\$ 130.63
BW-D2640 - BL	40 Qt./37L Champ Heavy Duty - Bucket Only - Blue	18.2	8.25	3.58	1	\$ 130.63
BW-D2640 - BR	40 Qt./37L Champ Heavy Duty - Bucket Only - Brown	18.2	8.25	3.58	1	\$ 130.63
BW-D2640 - GY	40 Qt./37L Champ Heavy Duty - Bucket Only - Grey	18.2	8.25	3.58	1	\$ 130.63

26-30 QT SMALL CHAMP BUCKETS /

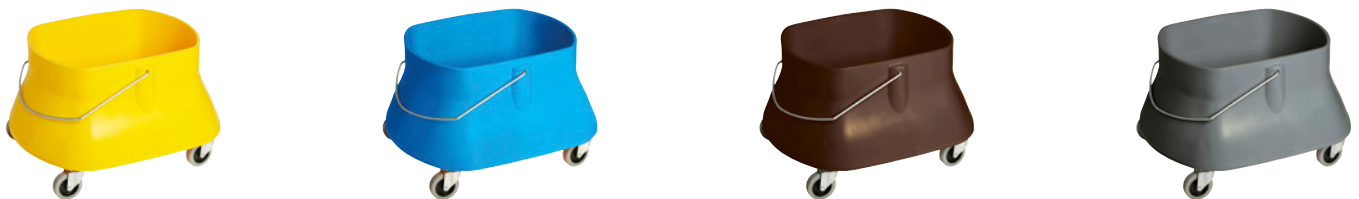

BW-D2632 - YE	30 Qt./29L Junior Champ Heavy Duty - Bucket Only - Yellow	25	11.3	2.4	1	\$ 91.58
BW-D2632 - BL	30 Qt./29L Junior Champ Heavy Duty - Bucket Only - Blue	25	11.3	2.4	1	\$ 91.58
BW-D2632 - BR	30 Qt./29L Junior Champ Heavy Duty - Bucket Only - Brown	25	11.3	2.4	1	\$ 91.58
BW-D2632 - GY	30 Qt./29L Junior Champ Heavy Duty - Bucket Only - Grey	25	11.3	2.4	1	\$ 91.58



ELEPHANT FOOT & GRIZZLY DOWN PRESS WRINGERS / FRENCH

- Wrings out mops faster than side squeeze wringers
- More efficient wringing
- avoids water splashing on the floor.

- Plus rapide que la presse d'essorage latérale
- Essorage très efficace
- Pas d'éclaboussures d'eau sur le plancher

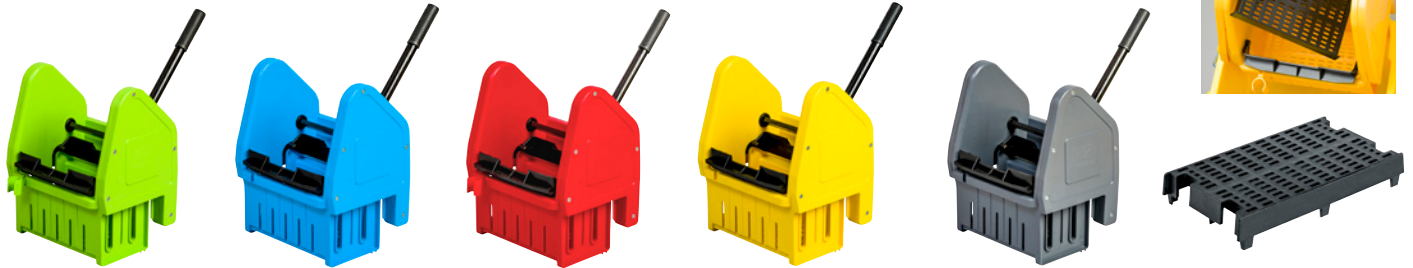

M2 Code Code M2	Description	Pack Wt LB (S) Poids (lb) (S)	Pack Wt KG Poids (kg)	Cubic Ft Pi3	Pack Contenu	List Price Liste des prix
BW-D33101-GN	Down Press Wringer – Green / Essoreuse pression descendante – vert	11	5	2.5	1	\$ 112.06
BW-D33101-BL	Down Press Wringer – Blue / Essoreuse pression descendante – bleu	11	5	2.5	1	\$ 112.06
BW-D33101-RD	Down Press Wringer – Red / Essoreuse pression descendante – rouge	11	5	2.5	1	\$ 112.06
BW-D33101-YE	Down Press Wringer – Yellow / Essoreuse pression descendante – jaune	11	5	2.5	1	\$ 112.06
BW-D33101-GY	Down Press Wringer – Grey / Essoreuse pression descendante – Gris	11	5	2.5	1	\$ 112.06
BW-AC3310	Wringer Insert - Black / Réducteur de presse d'essorage (noir)				1	\$ 22.54

CHAMP DOWN PRESS WRINGERS /

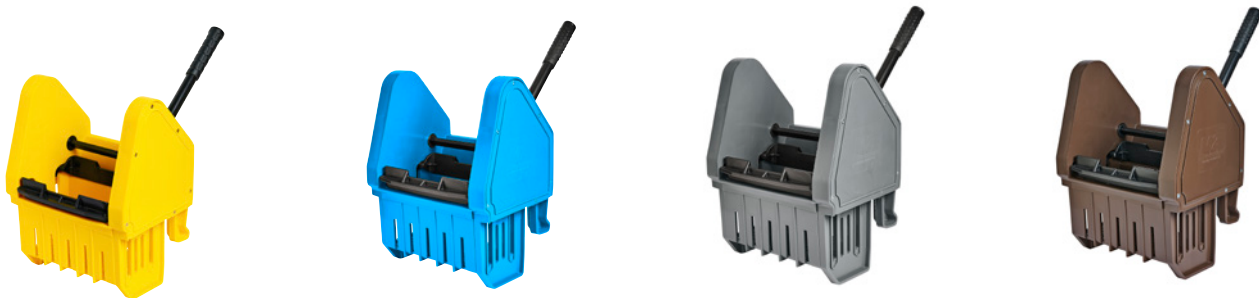

BW-D1232-YE	Champ Down Press Wringer – Yellow / Essoreuse pression descendante Champ – jaune	11	5	2.5	1	\$ 123.73
BW-D1232-BL	Champ Down Press Wringer – Blue / Essoreuse pression descendante Champ – bleu	11	5	2.5	1	\$ 123.73
BW-D1232-GY	Champ Down Press Wringer – Grey / Essoreuse pression descendante Champ – gris	11	5	2.5	1	\$ 123.73
BW-D1232-BN	Champ Down Press Wringer – Brown / Essoreuse pression descendante Champ – brun	11	5	2.5	1	\$ 123.73

CHAMP SIDE PRESS WRINGERS /



BW-S73500-GN	Side Press Wringer – Green / Essoreuse pression latérale – vert	11	5	2.5	1	\$ 90.88
BW-S73500-BL	Side Press Wringer – Blue / Essoreuse pression latérale – bleu	11	5	2.5	1	\$ 90.88
BW-S73500-RD	Side Press Wringer – Red / Essoreuse pression latérale – rouge	11	5	2.5	1	\$ 90.88
BW-S73500-YE	Side Press Wringer – Yellow / Essoreuse pression latérale – jaune	11	5	2.5	1	\$ 90.88
BW-S73500-GY	Side Press Wringer – Grey / Essoreuse pression latérale – Gris	11	5	2.5	1	\$ 90.88

SPECIALTY COMBOS / ENSEMBLES SPÉCIAUX

22 QT JUNIOR SIDE PRESS COMBOS / ENSEMBLES COMPACT SEAU-ESSOREUSE LATÉRALE, 22 PINTES

- 22 qt. capacity for smaller areas
- economical alternative design
- ideal for small areas or homes
- 22 pintes, pour de petites superficies
- Conception économique
- Idéal pour les petites superficies et chez soi

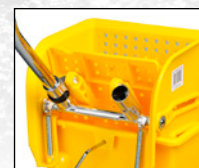

M2 Code	Description	Pack Qty	Unit Qty	Cubic Ft	Pack Contenu	List Price
BW-S1011 - YE	22 Qt Junior Side Press Bucket Combo - Yellow / Ensemble compact seau-essoreuse latérale, 22 pte - jaune	9	4	1.3	1	\$ 88.76
BW-S1011- BL	22 Qt Junior Side Press Bucket Combo - Blue / Ensemble compact seau-essoreuse latérale, 22 pte - bleu	9	4	1.3	1	\$ 88.76

26 QT SIDE PRESS COMBO YELLOW / ENSEMBLE ESSOREUSE LATÉRALE, 26 PTES – JAUNE



35 QT BUCKET WITH FUNNEL WRINGER AND WHEELS / 35 PINTES SEAU AVEC ESSOREUSE EN ENTONNOIR



M2 Code	Description	Pack Wt LB (S)	Pack Wt KG	Cubic Ft	Pack	List Price
Code M2		Poids (lb) (S)	Poids (kg)	PI3	Contenu	Liste des prix
BW-S26000	26 Qt Side Press Combo / Ensembleessoreuse latérale, 26 ptes-jaune				1	\$ 103.13
BW-FU3500	35 Qt Bucket with Funnel Wringer and Wheels / 35 pintes Seau avecessoreuse en entonnoir				1	\$ 161.96

SPECIALTY COMBOS / ENSEMBLES SPÉCIAUX

Deluxe 40 qt. Side Press combo with dirty water
Ensembleessoreuse descendante de luxe 40 pintes avec séparateur d'eau sale.



M2 Code	Description	Pack Wt LB (S)	Pack Wt KG	Cubic Ft	Pack	List Price
Code M2		Poids (lb) (S)	Poids (kg)	PI3	Contenu	Liste des prix
BW-S41000	Deluxe 40 Qt. Side Press Combo with Dirty Water Divider / Ensembleessoreuse descendante de luxe 40 pintes avec séparateur d'eau sale.	16.3	7.4	4.1	1	\$ 162.75
BW-S42202-YE	Deluxe 40 Qt. Bucket for Dirty Water with Divider /				1	\$ 162.75



BUCKETS & PAILS / SEAUX ET SEAUX



12 L HEAVY DUTY BUCKET WITH CONE WRINGER

- High impact bucket
- Removable Cone Wringer

SEAU ROBUSTE 12 L AVEC ESSOREUSE EN ENTONNOIR

- Seau très résistant
- Essoreuse en entonnoir amovible

7.5 L Each Side /
7.5 L chaque côté



15 L HEAVY DUTY DOUBLE BUCKET WITH CONE WRINGER

- High impact bucket
- Heavy Duty Removable Large Cone Wringer
- Separates Clean & Dirty Water

DOUBLE SEAU ROBUSTE 15 L AVEC ESSOREUSE EN ENTONNOIR

- Seau très résistant
- Grande essoreuse en entonnoir très résistante
- * Séparateur d'eau propre et sale

M2 Code Code M2	Description	Pack Wt LB (5) Poids (lb) (5)	Pack Wt KG Poids (kg)	Cubic Ft Pi3	Pack Contenu	List Price Liste des prix
PA-M1082	12 L Heavy Duty Bucket with Cone Wringer - Blue / 12 L Seau robuste avec essoreuse en entonnoir - bleu	15.5	7	3	10/1	\$ 31.94
PA-M1083	15 L Heavy Duty Double Bucket with Cone Wringer - Blue / 15 L Double seau robuste avec essoreuse en entonnoir - bleu	26.7	12	4	10/1	\$ 46.46

MOP CONE PAIL

- High impact bucket
- Fold down handle and cone wringer

SEAU AVEC ESSOREUSE EN FORME D'ENTONNOIR

- Seau très résistant
- Anse rabattable et essoreuse en forme d'entonnoir



DOUBLE BUCKET WITH CONE WRINGER DOUBLE SEAU AVEC ESSOREUSE EN FORME D'ENTONNOIR

Wringer Slides from Side-to-Side
L'essoreuse glisse d'un côté à l'autre



DOUBLE BUCKET WITH CONE WRINGER DOUBLE SEAU AVEC ESSOREUSE EN FORME D'ENTONNOIR



PA-M1070	Mop Cone Pail - Blue / Seau avec essoreuse en forme d'entonnoir - bleu	17	8	5	10/1	\$ 16.57
PA-M1080	Double Bucket with Cone Wringer - Yellow / Double seau avec essoreuse en forme d'entonnoir - jaune	15	7	2.6	5/1	\$ 38.27
PA-UT1012-2	12L Pail with Cone Wringer - Blue / 12L seau avec essoreuse conique - bleu	10.8	4.9	1.6	10	\$ 14.44
PA-UT1015	15L Pail with Cone Wringer - Blue / 15L seau avec essoreuse conique - bleu	15	6.8	3.1	12	\$ 14.68

12 L PAIL WITH HANDLE 12L SEAU AVEC POIGNÉE



10 QT PAIL WITH SPOUT SEAU AVEC BEC VERSEUR, 10 PINTES



14 QT HEAVY DUTY PAIL WITH SPOUT SEAU ROBUSTE AVEC BEC VERSEUR, 14 PINTES



15 L HEAVY DUTY PAIL - RED/BLUE SEAU ROBUSTE 15 L - ROUGE/BLEU



16 QT. DOUBLE BUCKET - LARGE/ 16 PTS SEAU DOUBLE - GRAND



PA-UT1012	12L Pail with Handle - Blue / seau bleu seulement avec poignée 12L - bleu	1.0	.5	2.6	24/1	\$ 11.14
PA-UT10	10 Qt Heavy Duty Utility Pail - Red / Seau très résistant, 10 pte - rouge	10	4.5	1.8	12	\$ 16.32
PA-UT14	14 Qt Heavy Duty Utility Pail -Grey / Seau très résistant, 10 pte - Gris				12	\$ 22.00
EFM-PA1015-BL	15 L Heavy Duty Pail - Blue / Seau robuste 15L bleu	.99	.44	2.6	15/1	\$ 43.57
EFM-PA1015-RD	15 L Heavy Duty Pail - Red / Seau robuste 15L rouge	.99	.44	2.6	15/1	\$ 43.57



EFM-PA1006-BL	6L / 6.3 Qt Mini-Pour Pail - Blue / Mini-seau verseur 6L/6.3p - bleu	.7	.3		4/1	\$ 20.24
EFM-PA1006-GN	6L / 6.3 Qt Mini-Pour Pail -Green / Mini-seau verseur 6L/6.3p - vert	.7	.3		4/1	\$ 20.24
EFM-PA1006-RD	6L / 6.3 Qt Mini-Pour Pail - Red / Mini-seau verseur 6L/6.3p - rouge	.7	.3		4/1	\$ 20.24
EFM-PA1006-YE	6L / 6.3 Qt Mini-Pour Pail - Yellow / Mini-seau verseur 6L/6.3p - jaune	.7	.3		4/1	\$ 20.24
EFM-PA1006-Lid	6L Mini-Pour Pail Lid Only / Couvercle pour mini-seau verseur 6L seulement	1.5	.7		1	\$ 17.80



M2 Code Code M2	Description	Pack Wt LB (S) Poids (lb) (S)	Pack Wt KG Poids (kg)	Cubic Ft Pi3	Pack Contenu	List Price Liste des prix
PA-3603G	3 Qt Cleaning Pail - Green	4	1.8	7.8	1	\$ 11.83
PA-3603R	3 Qt Sanitizer Cleaning Pail - Red	4	1.8	7.8	1	\$ 11.83
PA-3606G	6 Qt Cleaning Pail - Green	3.95	2.69	9	1	\$ 17.74
PA-3606R	6 Qt Sanitizer Cleaning Pail - Red	3.95	2.69	9	1	\$ 17.74

M2 360° EASY SPINMOP - EXPRESS

THE MOP THAT ADDS A "NEW" SPIN TO CLEANING!

- Clean any hard surface with ease!
- Patented bucket with centrifugal technology
- Control the level of moisture in the mop
- Wash & dry the super-absorbent mop in the same bucket!

LA VADROUILLE ROTATIVE RÉVOLUTIONNAIRE!

- Nettoyez toute surface lisse et solide très facilement!
- Seau breveté avec technologie centrifuge
- Contrôlez le niveau d'eau dans la vadrouille
- Lavez et asséchez la vadrouille super-absorbante dans le mêmeseau!



CARACTÉRISTIQUES

- Vadrouille lavable en microfibre qui ne laisse aucune égratignure et retient jusqu'à 10 fois son poids!

FEATURES

- Washable microfiber that leaves no scratches & holds up 10 times its weight!



PA-SM3800	360° EasySpin Mop Combo - Black/Red / Ensemble vadrouille "Spin mop" - noir/rouge	20.7	9.3	1.2	3/1	\$ 81.75
PA-SM3601	360° EasySpin Mop Refill Only - Short / Recharge vadrouille "Easy Spin" courte seulement	.25	.15	.03	1	\$ 6.72

ROLLER SPONGE MOP / VADROUILLE ÉPONGE RONDE

- Double bucket allows you to separate cleaning solution from dirty water
- Wide spout allows for easier pouring of liquids.
- Comfort grip handle for carrying
- Can be used with the roller sponge mop
- Great for office and small clean ups

. Le double seau permet de séparer la solution nettoyante de l'eau sale.

. Le bec large permet un coulage plus facile des liquides.

. Poignée de maintien confortable pour le transport.

. Peut être utilisé avec la vadrouille à rouleau.

. Idéal pour le bureau et les petits nettoyages.



SM-R1025	10" / 25cm Roller Sponge mop / Vadrouille éponge ronde 10"/25cm	11.5	5.2	4.3	12	\$ 56.58
SM-R1025R	10" / 25cm Roller Sponge mop Refill / Recharge de vadrouille éponge ronde 10"/25cm	6	2.72	3.56	24	\$ 23.56
DB-8216	16 Qt. Double Bucket - Large / 16 pts Seau double - grand	19.4	8.8	3.5	5/1	\$ 32.27



WAXING BUCKET WITH SIEVE / SEAU AVEC TAMIS POUR APPLIQUER LA CIRE



- High impact bucket with waxing sieve
- Durable handle for easy carrying
- Sieve can be used with Microfiber mops for floor finish applications
- Removable cap for water drainage on opposite side of bucket
- Swivel casters

- Seau résistant avec tamis pour appliquer la cire
- Transport facile grâce à l'anse durable
- Tamis utilisable avec des vadrouilles en microfibras pour l'application d'un fini à plancher
- Bouchon de vidange amovible sur l'autre paroi du seau
- Roulettes pivotantes



Refer to page ----- for Duo Microfiber mop
Se reporter à la page 139 pour la vadrouille Duo en microfibre

M2 Code Code M2	Description	Pack Wt LB (S) Poids (lb) (S)	Pack Wt KG Poids (kg)	Cubic Ft Pi3	Pack Contenu	List Price Liste des prix
PA-WX1100	Waxing Mop Bucket / Seau pour appliquer la cire	16.5	7.5	4.7	2/1	\$ 107.25

WINDOW BUCKET /SEAU À VITRES



25 L / 6 US GALLON CAPACITY / CAPACITÉ

- Durable handle for easy carrying
- Swivel wheels for easy maneuverability

- Transport facile grâce à l'anse durable
- Roulettes pivotantes pour une grande maniabilité

M2 Code Code M2	Description	Pack Wt LB (S) Poids (lb) (S)	Pack Wt KG Poids (kg)	Cubic Ft Pi3	Pack Contenu	List Price Liste des prix
PA-W1120	Window Bucket with Caddy and Wheels – Yellow / Seau à vitres, jaune	26.5	12	3.7	5	\$ 45.37

WINDOW BUCKET /SEAU À VITRES

25 L / 6 US GALLON CAPACITY / CAPACITÉ WATERTIGHT SEAL / JOINT ÉTANCHE À L'EAU



M2 Code Code M2	Description	Pack Wt LB (S) Poids (lb) (S)	Pack Wt KG Poids (kg)	Cubic Ft Pi3	Pack Contenu	List Price Liste des prix
EFM-PS-10100-BL	Window Bucket - Blue / Seau à vitres - bleu	68.3	31	1.5	10/1	\$ 53.80
EFM-PS-10101-BL	Window Bucket Lid - Blue / Couvercle pour seau à vitres - bleu				1	\$ 28.74
EFM-PS-10102-RD	Window Bucket - Red / Seau à vitres - rouge	68.3	31	1.5	10/1	\$ 53.80
EFM-PS-10103-RD	Window Bucket Lid - Red / Couvercle pour seau à vitres - rouge				1	\$ 28.74
EFM-PS-10104	Presoak Bucket Wheels Only (Set of 4) / Roues pour seau de pré-trempage seulement (pq de 4)				1	\$ 32.06

CARTS / CHARIOTS



CA-M1000
STANDARD
JANITOR CART /
NORME
CHARIOT DE NETTOYAGE -



LARGE JANITOR'S CART

- Front platform holds mop buckets & circular garbage cans
- Easy-to-clean surface
- Reinforced base with heavy duty casters will withstand rugged use
- Multiple hooks for holding dustpans, floor signs, mop handles, caution signs and broom tools
- 3" Casters on the front for easy maneuvering around corners
- Large 8" caster on the back for rugged surfaces
- Includes a heavy duty zippered bag which allows for easy removal of waste

CHARIOT DE NETTOYAGE

- Plateforme avant pour les seaux et les poubelles rondes
- Surface facile à nettoyer
- Base renforcée dotée de roues extra robustes résistant aux usages intensifs
- Plusieurs crochets pour les porte-poussière, les enseignes, les manches de vadrouilles, les panneaux d'avertissement, les vadrouilles et les accessoires
- Roues avant de 3 po pour manœuvrer facilement le chariot dans les coins
- Roues arrière de 8 po pour les surfaces rugueuses
- Comprend un sac robuste à glissière qui permet de retirer facilement les déchets

M2 Code Code M2	Description	Pack Wt LB (S) Poids (lb) (S)	Pack Wt KG Poids (kg)	Cubic Ft Pi3	Pack Contenu	List Price Liste des prix
JAN CART DELUXE / DE LUXE						
CA-M1000	Standard Janitor Cart / Chariot de nettoyage. norme	31	14	4.7	1	\$ 276.58
CA-M1001	70L Deluxe Zippered Janitor Cart Bag Only - 13"x 9"x 30" (35 x 25 x 78cm) 70L Chariot de nettoyage, zippered sac seulement - 13"x 9"x 30" (35 x 25 x 78cm)	1	.4		1	\$ 44.73

LARGE JANITOR CART/ CHARIOT DE NETTOYAGE GRAND



M2 Code Code M2	Description	Pack Wt LB (S) Poids (lb) (S)	Pack Wt KG Poids (kg)	Cubic Ft Pi3	Pack Contenu	List Price Liste des prix
JAN CART / CHARIOT TRADITION						
CA-M2000	Large Janitors Cart with Zippered Bag - Yellow / Chariot de nettoyage avec sac à fermeture éclair - jaune	31	14	4.7	1	\$ 334.93
CA-M2001	65L Large Janitors Cart with Zipper - Bag Only - Yellow - 15"x 10"x 27" (39 x 27 x 70cm) Chariot de nettoyage avec sac à fermeture éclair - Sac seulement - jaune - 15"x 10"x 27" (39 x 27 x 70cm)	2.30	1	1	1	\$ 52.11



LARGE JANITOR'S CART WITH ZIPPERED BAG & LOCKING CABINET



M2 Code Code M2	Description	Pack Wt LB (S) Poids (lb) (S)	Pack Wt KG Poids (kg)	Cubic Ft Pi3	Pack Contenu	List Price Liste des prix
LARGE JANITOR CART WITH ZIPPERED BAG & LOCKING CABINET						
CA-M2200	Large Black Janitor Cart with Zippered Bag Locking Cabinet - Black /	33.9	15.4	5	1	\$ 404.50

LAUNDRY COLLECTION CART / CHARIOT PLIANT



- Strong durable X-frame molded with high density plastic
- Easy collapsible frame makes it convenient to store
- Non marking casters for easy movement of cart

- Cadre en X robuste et durable moulé dans du plastique ultra-résistant
- Cadre pliable pour un entreposage facile
- Roues qui ne laissent pas de traces pour déplacer facilement le chariot

M2 Code Code M2	Description	Pack Wt LB (S) Poids (lb) (S)	Pack Wt KG Poids (kg)	Cubic Ft Pi3	Pack Contenu	List Price Liste des prix
CA-M1800	X-Cart Mobile Trolley / Chariot mobile pliant, cadre en X	23.5	10.7	4.5	1	\$ 283.04
CA-M1801	X-Cart – Bag Only - 20 x 22 x 28" / 50 x 56 x 72cm / Chariot, cadre en X, sac seulement	1	.5		1	\$ 91.18

LARGE HOUSEKEEPING CART



LARGE HOUSEKEEPING CART

Product size:

58.2" x 21.6" x 51.18"
(148cm x 55cm x 130cm)

- 2 large moveable shelves that are smooth and easy to clean
- Molded with high density plastic for extra durability
- Handles on both ends with bag accommodation
- Non-marking wheels, allow for easy movement especially in tight areas

GRAND CHARIOT DE MÉNAGE

Product size:

58.2" x 21.6" x 51.18" (148cm x 55cm x 130cm)

- Deux grandes tablettes mobiles qui sont lisses et faciles à nettoyer
- Moulé avec du plastique haute densité pour une durabilité accrue
- Poignées aux deux extrémités avec logement de sac.
- Des roues non marquantes, permettent un mouvement facile en particulier dans les zones étroites.

CA-HK5813	Large HouseKeeping Cart / Grand charriot de ménage	103.6	47	10.1	1	\$ 747.44
-----------	--	-------	----	------	---	-----------

HIGH SECURITY JANITOR CART



HIGH SECURITY JANITOR CART

Product size:

52.5" x 23.6" x 54.3"
(133 x 60 x 138cm)

- Locking cabinet doors and locking security hood
- Bi-directional retractable door to improve the work efficiency

CHARIOT DE MÉNAGE HAUTE SÉCURITÉ

Taille du produit:

52.5" x 23.6" x 54.3"
(133 x 60 x 138cm)

- Porte de cabinet avec barrure penture sécuritaire
- Porte bi-directionnelle retractable pour améliorer l'efficacité du travail

DOOR WITH KEY LOCK / PORTE AVEC SERRURE À CLÉ

CA-HS4800	High Security Janitor Cart / Chariot de concierge Haute-sécurité	79.3	36	11.6	1	\$ 1,244.66
CA-HS4801	Bag Only for High Security Janitor Cart				1	\$ 106.95

COLLECTION TROLLEY WITH LOCK



COLLECTION TROLLEY WITH LOCK

Product size:

56.6" x 23.6 x 45.2"
(144 x 60 x 115cm)

- Large Capacity Collection Cart.
- Bag can hold up to 34 Gal. of rubbish

CHARIOT DE COLLECTION AVEC SERRURE

Taille du produit:

56.6" x 23.6 x 45.2"
(144 x 60 x 115cm)

- Chariot de marque Collection grande capacité
- Sac pouvant contenir plus de 34 livres de déchets

CA-CT4900	Collection Trolley With Lock / Chariot de ramassage avec serrure	80.4	36.5	4.9	1	\$ 1,171.14
-----------	--	------	------	-----	---	-------------



INDUSTRIAL CART / CHARIOT PLATE-FORME

The M2 Service Utility Cart is ideal for use in a warehouse, the garage, foodservice facilities, perfect for Industrial or medical use or any place a rugged cart is needed. Lightweight design allows this cart to be easily maneuvered on 5" non marking casters.

Les chariots utilitaires de M2 sont idéaux pour être utilisés dans un entrepôt, le garage, le chargement de nourriture, pour un usage industriel ou médical, parfait où tout chariot est nécessaire. La conception légère permet de manutentionner facilement ce chariot sur des roulettes non marquantes de 5".

Small/Petit



Large/Grand



Easy assembly.
Assemblage facile.

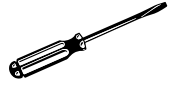

Fixed Front /
Roues fixes à l'avant

Swivel Back /
Roues pivotantes à l'arrière



Casters Included: / Roulettes incluses:
5" x 1 1/4" non marking / non marquantes

300lbs/136kg Load Capacity
Each Shelf 70lbs/32kgs
300 lb / 136 Kg Capacité de chargement
70 lb / 32 kg Chaque tablette

500lbs/227kg Load Capacity
Each Shelf 120lbs/55kgs
500 lb / 227 kg Capacité de chargement
120 lb / 55 kg Chaque tablette

M2 Code Code M2	Description	Pack Wt LB (S) Poids (lb) (S)	Pack Wt KG Poids (kg)	Cubic Ft Pi3	Pack Contenu	List Price Liste des prix
CA-UT1900	Small Utility Cart / Petit chariot utilitaire - L 34.4" x P 17.5" x H 32.6" (87cm x 44cm x 83cm)	40.8	18.5	3.5	1	\$ 283.76
CA-UT1950	Large Utility Cart / Grand chariot utilitaire - L 40.4" x P 25.5" x H 32.6" (103cm x 65cm x 83cm)	51.9	23.5	5.9	1	\$ 348.97

SMALL UTILITY CART / PETIT CHARIOT DE SERVICE



Shelf Weight Capacity 55 lb / 25 kg
Étagère - Capacité de charge 55 lbs/25Kg

LARGE UTILITY CART / GRAND CHARIOT DE SERVICE



Shelf Weight Capacity 55 lb / 25 kg
Étagère - Capacité de charge 55 lbs/25 Kg

DELUXE UTILITY CART / CHARIOT DE SERVICE DE LUXE



Shelf Weight Capacity 55 lb / 25 kg
Étagère - Capacité de charge 55 lbs/25 Kg

- Durable handles at both ends • 3 Strong shelves
- Easy to maneuver in tight areas garbage cans
- Assembly required

- Poignées robustes et durables • Trois étagères robustes et durables
- Facile à manœuvrer dans des espaces exigus
- Assemblage requis

CA-UT1840	Small Utility Cart / Petit chariot de service	22	10	2.6	1	\$ 229.82
CA-UT1850	Large Utility Cart / Grand chariot de service	35	16	4	1	\$ 328.31
CA-UT1860	Large Deluxe Utility Cart - Black / Grand chariot de service Deluxe, noir	34	15.5	6	1	\$ 348.97

INDUSTRIAL CART / CHARIOT PLATE-FORME

- Durable frame molded with high density plastic
- Easy collapsible handle makes it convenient to store
- Non marking casters for easy movement of cart
- Cadre durable moulé avec du plastique ultra-résistant
- Poignée rabattable pour un entreposage facile
- Roues qui ne laissent pas de traces pour manœuvrer facilement le chariot.



250 LB. WEIGHT
CAPACITY 113.4 KG /
Capacité de charge
250 Lbs / 113.4 Kg



CA-13100	Industrial Box Cart / Chariot plate-forme pour le transport de boîtes	23	11	2	1	\$ 211.13
----------	---	----	----	---	---	-----------

MAID CADDY/TOTES / BOÎTES DE RANGEMENT AVEC POIGNÉE

- Strong durable and lightweight
- Can hold a wide variety of cleaning tools
- Will fit most hotel and janitorial carts
- Robuste, durable et légère
- Peut contenir une vaste gamme de produits de nettoyage
- S'adapte à la plupart des chariots d'hôtel et de ménage

MEDIUM / MOYENNE



LARGE / GRANDE



TO-P11	All Purpose Caddy - Medium - 15"W x 9"D x 5"H / Boîte de rangement tout usage, moyenne, 15 x 9 x 5 (L x P x H)	18	8	3.2	15/1	\$ 19.91
TO-P12	All Purpose Caddy - Large - 16"W x 11"D x 5"H / Boîte de rangement tout usage, grande, 16 x 11 x 5 (L x P x H)	20	9	3.5	15/1	\$ 20.08

CAUTION WET FLOOR SIGNS 28"/71CM / PANNEAUX «ATTENTION, PLANCHER MOUILLÉ» 28"/71CM

The new pinch free hinge system and taller design makes them stronger, preventing them from flattening out.

The four point stance prevents them from leaving marks on waxed floors.

En raison de leur nouveau système de charnières et de leur hauteur, les panneaux sont plus robustes et ne peuvent plus s'affaisser. Les quatre points d'appui permettent qu'ils ne laissent pas de traces sur les planchers cirés.



M2 Code Code M2	Description	Pack Wt LB (S) Poids (lb) (S)	Pack Wt KG Poids (kg)	Cubic Ft Pi3	Pack Contenu	List Price Liste des prix
WF-7000	Floor Sign – Blank / Panneau – vide	12	5.5	2	6	\$ 21.97
WF-7003-BK	BLACK - "Recycled" Caution Wet Floor – Eng// Fr / Panneau « Attention, plancher mouillé » noir recyclé - anglais / français	12	5.5	2	6	\$ 20.39
WF-7003	Floor Sign "Caution Wet Floor" – Eng/Fr/Sp / Panneau « Attention, plancher mouillé », anglais / français / espagnole	12	5.5	2	6	\$ 22.40
WF-7005	Floor Sign "Caution Wet Floor" – English / Panneau « Caution Wet Floor », anglais	12	5.5	2	6	\$ 22.40
WF-7006	Floor Sign "Closed" – English/French/Spanish / Panneau « Fermé », anglais / français / espagnol	12	5.5	2	6	\$ 22.40



WF-7007	Floor Sign "Caution Wet Floor" – English/Spanish / Panneau « Caution Wet Floor », anglais / espagnol	12	5.5	2	6	\$ 22.40
WF-7008	Floor Sign "No Entry Restroom Closed" – English / Panneau « Pas d'entrée - toilettes fermées », anglais	12	5.5	2	6	\$ 22.40
WF-7011	Floor Sign "Caution Wet Floor" - French/English	12	5.5	2	6	\$ 22.40
WF-7012	Floor Sign "Cleaning in Progress" - French/English	12	5.5	2	6	\$ 22.40

SPECIALTY CAUTION SIGNS / ENSEIGNES D'AVERTISSEMENT SPÉCIALISÉES



SAFETY POP-UP SIGN

Product size:
28" x 14" (70 x 35cm)

ENSEIGNE DE SÉCURITÉ "POP-UP"

Taille du produit:
28" x 14" (70 x 35cm)



SAFETY PYLON SIGN

Product size: 30" (76 cm)
Create an obstacle course, mark boundaries, or practice agility with the Hi-Visibility Fluorescent Poly Cone.

PYLÔNE DE SÉCURITÉ

Taille du produit: 30" (76 cm)
Créez un parcours d'obstacles, marquez les limites ou pratiquez l'agilité avec le pylône fluorescent.

WF-C9020	4 Sided Safety Caution Sign – Small / Panneau de sécurité à 4 faces - petit				10/1	\$ 53.56
WF-C9021	4 Sided Safety Caution Sign – Large - Eng/Fr / Panneau de sécurité à 4 faces - grand				10/1	\$ 59.45
WF-C9021-SP	4 Sided Safety Caution Sign – Large - Eng/Sp / Panneau de sécurité à 4 faces - grand				10/1	\$ 59.45
WF-D9002	Hanging Door Sign "Closed for Cleaning" - English / French Enseigne de porte suspendu "Fermé pour le nettoyage" - anglais / français	11	5	1.7	12/1	\$ 38.70
WF-P2020	Safety Pop-Up Sign / Enseigne de sécurité "Pop-up"				12	\$ 29.84
WF-C2828	Safety Pylon Cone Sign 28"(70cm) - Orange / Pylône de sécurité orange 28" (70cm)				6	\$ 58.44

* All Artwork, Plates and Screens are at addition costs. ** Minimum quantity required. Inquire with your sales representative.

* Les illustrations et les plaques d'impression sont disponibles moyennant le paiement de frais supplémentaires. ** Quantité minimale requise. Se renseigner auprès du représentant des ventes à ce propos.



FOOD SERVICE - COLOUR WASTE CONTAINERS / CONTENEURS DE DÉCHETS COULEURS



WHITE / BLANC						
WM-PRH1010-WH	10 Gal. / 38L – White / Seau à glace, 10 gal./ 38 L , blanc	6	2.8	6/1		\$ 49.65
WM-PRH2020-WH	20 Gal. / 75 L Heavy Duty Waste Container – White / Poubelle, 20 gal./ 75 L , blanc	6	2.8	6/1		\$ 61.51
WM-PRH3232-WH	32 Gal. / 121 L Heavy Duty Waste Container – White / Poubelle, 32 gal. / 121 L , blanc	8	3.8	4/1		\$ 82.68
WM-PRH4444-WH	44 Gal. / 166 L Heavy Duty Waste Container – White/ Poubelle, 44 gal./ 166 L , blanc	13	6	3/1		\$ 123.59
GREY / GRIS						
WM-PRH1010-GY	10 Gal. / 38L Ice Bucket – Grey / Seau à glace, 10 gal./ 38 L , gris	6	2.8	6/1		\$ 49.65
WM-PRH2020-GY	20 Gal. / 75 L Heavy Duty Waste Container – Grey / Poubelle, 20 gal./ 75 L , gris	6	2.8	6/1		\$ 61.51
WM-PRH3232-GY	32 Gal. / 121 L Heavy Duty Waste Container – Grey / Poubelle, 32 gal. / 121 L , gris	8	3.8	4/1		\$ 73.13
WM-PRH4444-GY	44 Gal. / 166 L Heavy Duty Waste Container – Grey/ Poubelle, 44 gal./ 166 L , gris	13	6	3/1		\$ 109.70
WM-PRH5555-GY	55 Gal. / 208L Heavy Duty Waste Container – Grey/ Poubelle, 55 gal./ 208 L , gris	15.3	7	3.2	2/1	\$ 246.41
GREEN / VERT						
WM-PRH2020-GN	20 Gal. / 75 L Heavy Duty Waste Container – Green / Poubelle, 20 gal./ 75 L , vert	6	2.8	6/1		\$ 61.51
WM-PRH3232-GN	32 Gal. / 121 L Heavy Duty Waste Container – Green / Poubelle, 32 gal. / 121 L , vert	8	3.8	4/1		\$ 82.68
WM-PRH4444-GN	44 Gal. / 166 L Heavy Duty Waste Container –Green/ Poubelle, 44 gal./ 166 L , vert	13	6	3/1		\$ 123.59
BLUE / BLEU						
WM-PRH2020-BL	20 Gal. / 75 L Heavy Duty Waste Container – Blue / Poubelle, 20 gal./ 75 L , bleu	6	2.8	6/1		\$ 61.51
WM-PR2020-BL-RYC	20 Gal. / 75 L Heavy Duty Recycled Waste Container – Blue / Poubelle, 20 gal./ 75 L , gris	6	2.8	6/1		\$ 73.83
WM-PRH3232-BL	32 Gal. / 121 L Heavy Duty Waste Container –Blue / Poubelle, 32 gal. / 121 L , bleu	8	3.8	4/1		\$ 82.68
WM-PR3232-BL-RYC	32 Gal. / 121 L Heavy Duty Recycled Waste Container – Blue / Poubelle, 32 gal. / 121 L gris	8	3.8	3/1		\$ 99.21
WM-PRH4444-BL	44 Gal. / 166 L Heavy Duty Waste Container –Blue / Poubelle, 44 gal./ 166 L , bleu	13	6	3/1		\$ 123.59
WM-PR4444-BL-RYC	44 Gal. / 166 L Heavy Duty Waste Recycled Container – Blue / Poubelle, 44 gal / 166 L gal, gris	13	6	3/1		\$ 136.01
RED / ROUGE						
WM-PRH2020-RD	20 Gal. / 75 L Heavy Duty Waste Container – Red / Poubelle, 20 gal./ 75 L , rouge	6	2.8	6/1		\$ 61.51
WM-PRH3232-RD	32 Gal. / 121 L Heavy Duty Waste Container –Red / Poubelle, 32 gal. / 121 L , rouge	8	3.8	4/1		\$ 82.68
WM-PRH4444-RD	44 Gal. / 166 L Heavy Duty Waste Container –Red / Poubelle, 44 gal./ 166 L , rouge	13	6	3/1		\$ 123.59
YELLOW / JAUNE						
WM-PRH2020-YE	20 Gal. / 75 L Heavy Duty Waste Container – Yellow / Poubelle, 20 gal./ 75 L , jaune	6	2.8	6/1		\$ 61.51
WM-PRH3232-YE	32 Gal. / 121 L Heavy Duty Waste Container –Yellow/ Poubelle, 32 gal. / 121 L , Jaune	8	3.8	4/1		\$ 82.68
WM-PRH4444-YE	44 Gal. / 166 L Heavy Duty Waste Container – Yellow / Poubelle, 44 gal./ 166 L , jaune	8	3.8	3/1		\$ 123.59
PURPLE / VIOLET - SPECIAL ORDER						
WM-PRH2020-PU	20 Gal. / 75 L Heavy Duty Waste Container – Purple / Poubelle, 20 gal./ 75 L , violet	6	2.8	N/S		\$ 61.51
WM-PRH3232-PU	32 Gal. / 121 L Heavy Duty Waste Container –Purple / Poubelle, 32 gal. / 121 L , violet	8	3.8	N/S		\$ 82.68
WM-PRH4444-PU	44 Gal. / 166 L Heavy Duty Waste Container – Purple / Poubelle, 44 gal./ 166 L , violet	13	6	N/S		\$ 123.59

COLOUR WASTE CONTAINERS LIDS / COUVERTS DE CONTENEURS DE DÉCHETS COULEURS



M2 Code Code M2	Description	Pack Wt LB (S) Poids (lb) (S)	Pack Wt KG Poids (kg)	Cubic Ft Pi3	Pack Contenu	List Price Liste des prix
WHITE / BLANC						
WM-PRH1010-L-WH	10 Gal. / 75 L Waste Container Lid – Heavy Duty - White /Couvercle de poubelle, 10 gal./ 75 L, blanc	8.8	4	1.7	6/1	\$ 24.17
WM-PRH2020-L-WH	20 Gal. / 75 L Waste Container Lid – Heavy Duty - White/ Couvercle de poubelle, 20 gal./ 75 L, blanc	8.8	4	1.7	4/1	\$ 27.00
WM-PRH3232-L-WH	32 Gal. / 121 L Waste Container Lid – Heavy Duty - White / Couvercle de poubelle, 32 gal. / 121 L, blanc	13	6	2.2	4/1	\$ 43.66
WM-PRH4444-L-WH	44 Gal. / 166 L Waste Container – Heavy Duty - White/ Couvercle de poubelle, 44 gal./ 166 L, blanc	15.3	7	3.2	3/1	\$ 77.93
GREY / GRIS						
WM-PRH1010-L-GY	10 Gal. / 75 L Waste Container Lid – Heavy Duty - Grey /Couvercle de poubelle, 10 gal./ 75 L, gris	8.8	4	1.7	6/1	\$ 24.17
WM-PRH2020-L-GY	20 Gal. / 75 L Waste Container Lid – Heavy Duty - Grey/ Couvercle de poubelle, 20 gal./ 75 L, gris	8.8	4	1.7	4/1	\$ 27.00
WM-PRH3232-L-GY	32 Gal. / 121 L Waste Container Lid – Heavy Duty - Grey / Couvercle de poubelle, 32 gal. / 121 L, gris	13	6	2.2	4/1	\$ 43.66
WM-PRH4444-L-GY	44 Gal. / 166 L Waste Container – Heavy Duty - Grey/ Couvercle de poubelle, 44 gal./ 166 L, gris	15.3	7	3.2	3/1	\$ 77.93
WM-PRH5555-L-GY	55 Gal. / 208 L Waste Container – Heavy Duty - Grey/ Couvercle de poubelle, 55 gal./ 208 L, gris	15.3	7	3.2	2/1	\$ 109.09
GREEN / VERT						
WM-PRH2020-L-GN	20 Gal. / 75 L Waste Container Lid – Heavy Duty - Green/ Couvercle de poubelle, 20 gal./ 75 L, vert	8.8	4	1.7	4/1	\$ 27.00
WM-PRH3232-L-GN	32 Gal. / 121 L Waste Container Lid – Heavy Duty - Green / Couvercle de poubelle, 32 gal. / 121 L, vert	13	6	2.2	4/1	\$ 43.66
WM-PRH4444-L-GN	44 Gal. / 166 L Waste Container – Heavy Duty - Green/ Couvercle de poubelle, 44 gal./ 166 L, vert	15.3	7	3.2	3/1	\$ 77.93
BLUE / BLEU						
WM-PRH2020-L-BL	20 Gal. / 75 L Waste Container Lid – Heavy Duty - Blue / Couvercle de poubelle, 20 gal./ 75 L, bleu	8.8	4	1.7	4/1	\$ 27.00
WM-PRH3232-L-BL	32 Gal. / 121 L Waste Container Lid – Heavy Duty - Blue / Couvercle de poubelle, 32 gal. / 121 L, bleu	13	6	2.2	4/1	\$ 43.66
WM-PRH4444-L-BL	44 Gal. / 166 L Waste Container – Heavy Duty - Blue/ Couvercle de poubelle, 44 gal./ 166 L, bleu	15.3	7	3.2	3/1	\$ 77.93
RED / ROUGE						
WM-PRH2020-L-RD	20 Gal. / 75 L Waste Container Lid – Heavy Duty - Red / Couvercle de poubelle, 20 gal./ 75 L, rouge	8.8	4	1.7	4/1	\$ 27.00
WM-PRH3232-L-RD	32 Gal. / 121 L Waste Container Lid – Heavy Duty - Red / Couvercle de poubelle, 32 gal. / 121 L, rouge	13	6	2.2	4/1	\$ 43.66
WM-PRH4444-L-RD	44 Gal. / 166 L Waste Container – Heavy Duty - Red / Couvercle de poubelle, 44 gal./ 166 L, rouge	15.3	7	3.2	3/1	\$ 77.93
YELLOW / JAUNE						
WM-PRH2020-L-YE	20 Gal. / 75 L Waste Container Lid – Heavy Duty - Yellow / Couvercle de poubelle, 20 gal./ 75 L, jaune	8.8	4	1.7	4/1	\$ 27.00
WM-PRH3232-L-YE	32 Gal. / 121 L Waste Container Lid – Heavy Duty - Yellow / Couvercle de poubelle, 32 gal. / 121 L, jaune	13	6	2.2	4/1	\$ 43.66
WM-PRH4444-L-YE	44 Gal. / 166 L Waste Container Lid – Heavy Duty - Yellow / Couvercle de poubelle, 44 gal./ 166 L, jaune	13	7	2.2	3/1	\$ 77.93
PURPLE / VIOLET - SPECIAL ORDER						
WM-PRH2020-L-PU	20 Gal. / 75 L Waste Container – Heavy Duty - Purple / Poubelle, 20 gal./ 75 L, violet	6	4	1.7	N/S	\$ 27.00
WM-PRH3232-L-PU	32 Gal. / 121 L Waste Container –Heavy Duty - Purple / Poubelle, 32 gal. / 121 L, violet	8	6	2.2	N/S	\$ 43.66
WM-PRH4444-L-PU	44 Gal. / 166 L Waste Container – Heavy Duty - Purple / Poubelle, 44 gal./ 166 L, violet	13	7	2.2	N/S	\$ 77.93

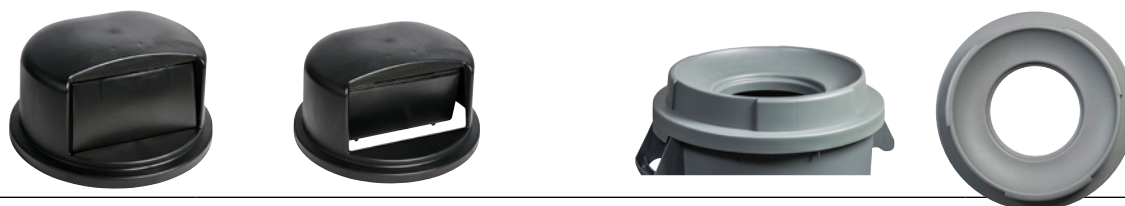

**Garbage Bag Size:
Grandeur sac à déchets:**
20 Gal./ 75 L – 30" x 38"
32 GAL / 121 L – 35" x 50"
44 GAL / 166 L – 42" x 48"

WM-PR3232BK-DO	32 Gallon Garbage Dome Lid - Black				1	\$ 275.00
WM-PR4455BK-DO	44 & 55 Gallon Garbage Dome Lid - Black				1	\$ 376.00
WM-PR2020G-FL	20 Gal. / 75 L Waste Container Lid – Grey / Couvercle de poubelle, 20 gal./ 75 L, gris	8.8	4	1.7	6/1	\$ 51.90
WM-PR3232G-FL	32 Gal. / 121 L Waste Container Lid – Grey / Couvercle de poubelle, 32 gal. / 81 L, gris	13	6	2.2	6/1	\$ 62.20



23 GAL SLIM GARBAGE CONTAINER/ POUBELLE 23 GAL RECTANGULAIRE MINCE



Garbage Bag Size: Grandeur sac à déchets: - 23 GAL / 87 L - SIZE: 30" X 38"

M2 Code Code M2	Description	Pack Wt LB (5) Poids (lb) (5)	Pack Wt KG Poids (kg)	Cubic Ft Pi3	Pack Contenu	List Price Liste des prix
WM-PR2323-BL-RYC	23 Gal / 110 Qt Rectangular Slim Garbage Container - Blue / Poubelle rectangulaire mince 23 / 110 Qt gallons-bleu-recycle	29	13.15	4.42	4/1	\$ 129.84
WM-PR2323-GN	23 Gal / 110 Qt Rectangular Slim Garbage Container - Green / Poubelle rectangulaire mince 23 / 110 Qt gallons-vert-recycle	29	13.15	4.42	4/1	\$ 129.84
WM-PR2323-GY	23 Gal / 110 Qt Rectangular Slim Garbage Container - Grey / Poubelle rectangulaire mince 23 / 110 Qt gallons-gris	29	13.15	4.2	4/1	\$ 97.17
WM-PR2323-BK	23 Gal / 110 Qt Rectangular Slim Garbage Container - Black / Poubelle rectangulaire mince 23 gallons / 110 Qt - noire	29	13.15	4.42	4/1	\$ 129.84
WM-PR2324-BL	23 Gal / 110 Qt Rectangular Slim Garbage Container - Lid Only - Paper Slot/Cans Blue / Couverture pour poubelle mince 23 / 110 Qt bleu-recycle avec trou pour cannette et papier	3	1.36	.42	4/1	\$ 56.00
WM-PR2325-GY	23 Gal / 110 Qt Rectangular Slim Garbage Container - Swing Lid Only - Grey / Couverture battant pour poubelle mince 23 / 110 Qt - gris	5	2.27	1.12	4/1	\$ 56.00
WM-PR2325-BK	23 Gal / 110 Qt Rectangular Slim Garbage Container - Swing Lid Only - Black / Couverture battant pour poubelle mince 23 / 110 Qt - noir	5	2.27	1.12	4/1	\$ 56.00
WM-PR2330D	Rectangular Slim Garbage Container Dolly /				6/1	\$ 280.00

ACCESSORIES / ACCESSOIRES

DOLLY FOR ROUND WASTE CONTAINERS

- 5-Wheel Dolly, locks into base, support for heavier loads
- Fits most containers

SOCLES POUR POUBELLES RONDES

- Socle 5 roues, se verrouille dans la base et offre un support supplémentaire pour les charges lourdes
- Convient à la plupart des poubelles



M2 Code	Description	Pack Wt LB (5)	Pack Wt KG	Cubic Ft	Pack	List Price
WM-D4000	Dolly for Waste Container / Socle pour poubelle	43.6	20	6	6/1	\$ 72.38
WM-AC4001	Caddy for 20, 32 and 44 Gallon Container - Yellow / Socle pour poubelles de 20, 32, 44 gal - jaune	1.5	1	.2	1	\$ 60.02
TO-P1850	Portable cleaning/storage caddy/For 32Gal,44Gal,Containers				4/1	\$ 73.51

“EZ-Push” Waste Containers

Conteneurs à déchets “Ez-push”



H - 17.75" W - 13.25" - D - 11.25"
45.5 cm x 33.6 cm x 28.5 cm
Bag Size / Taille du sac
22" x 24" / 55 x 60cm

H - 23.5" W - 16" - D - 13
59.6 cm x 40.6 cm x 32 cm
Bag Size / Taille du sac
26" x 36" / 66 x 91.5cm

H - 27.5" W - 16" - D - 16"
70 cm x 40.6 cm x 40.6 cm
Bag Size / Taille du sac
30" x 38" / 76 x 96.5cm

H - 34" W - 19.25" - D - 19.25"
86 cm x 49 cm x 49 cm
Bag Size / Taille du sac
42" x 48" / 106.5 x 122cm

H - 31" W - 13.25" - D - 18"
79 cm x 33.6 cm x 46 cm

*Dimensions include lids /
Les dimensions incluent les couvercles*

M2's New EZ-Push Square Waste Containers complete with Lids are made of durable plastic. They feature a smooth push-open door which conceals trash and contain odors. The removable lid makes for easy cleaning and effortless trash removal.

The ergonomically designed handles make lifting simple. Our EZ-Push Waste Containers are available in 25L, 40L, 60L, 100L and a Slim Rectangular 60L size to fit in tight spaces. Ideal in both indoor or outdoor. Colour: Grey

La nouvelle M2, « Ez-push » de conteneurs à déchets carrés complets, avec des couvercles, sont en plastique durable. Ils disposent d'une porte poussoir lisse qui cache la poubelle et masque les odeurs. Le couvercle amovible permet un nettoyage facile et l'enlèvement des ordures sans effort. Les poignées ergonomiques rendent le soulèvement facile.

Notre « Ez-push » de conteneurs à déchets sont disponibles en 25L, 40L, 60L, 100L et une taille de 60L rectangulaire mince pour tenir dans des espaces restreints. Idéal à la fois à l'intérieur ou à l'extérieur. Couleur : Gris

M2 Code Code M2	Description	Bag Size Bag Size	Pack Wt LB (S) Poids (lb) (S)	Pack Wt KG Poids (kg)	Cubic Ft Pi3	Pack Contenu	List Price Liste des prix
WM-PS0025	25L Waste Container with Lid – Grey / Poubelle carrée avec couvercle, 25L, gris	22" x 24"	26.9	11.3	3.9	10/1	\$ 32.33
WM-PS0040	40L Waste Container with Lid – Grey / Poubelle carrée avec couvercle, 40L, gris	26" x 36"	52.5	23.8	10.5	10/1	\$ 58.63
WM-PS0060	60L Waste Container with Lid – Grey / Poubelle carrée avec couvercle, 60L, gris	30" x 38"	52.5	23.8	10.5	5/1	\$ 83.89
WM-PS0100	100L Waste Container with Lid – Grey / Poubelle carrée avec couvercle, 100L, gris	42" x 48"	52.5	23.8	10.5	5/1	\$ 121.39
WM-PRO260	60L Rectangular Waste Container with Lid – Grey / Poubelle rectangulaire avec couvercle, 60L, gris	30" x 38"	52.5	23.8	10.5	4/1	\$ 85.56



WASTE BASKETS / PANIER À DÉCHETS

8 QT. / 8 PINTES

14 QT. / 14 PINTES

28 QT. / 28 PINTES

38 QT. / 41 PINTES



M2 Code Code M2	Description	Pack Wt LB (S) Poids (lb) (S)	Pack Wt KG Poids (kg)	Cubic Ft Pi3	Pack Contenu	List Price Liste des prix
WM-PS008	8 Qt / 7.5 L Waste Basket, Black / Panier à déchets 8 pts/7.5 L, noir	15.54	7.05	1.78	20/1	\$ 9.82
WM-PS014	14 Qt / 11 L Waste Basket, Black / Panier à déchets 14 pts / 11 L, noir	25.72	11.44	3.19	20/1	\$ 12.04
WM-PS028	28 Qt / 26 L Waste Basket, Black / Panier à déchets 28 pts / 26 L, noir	27.18	10.06	2.62	10	\$ 20.55
WM-PS028-BE	28 Qt / 26 L Waste Basket, Beige / Panier à déchets 28 pts / 26 L, beige - Special Order / Commande spéciale	27.18	10.06	2.62	10	\$ 20.55
WM-PS038	38 Qt / 36 L Waste Basket, Black / Panier à déchets 38 pts / 36 L, noir	28.79	13.06	3.88	10	\$ 23.88

RECYCLED WASTE BASKETS / BAC À RECYCLAGE



M2 Code Code M2	Description	Pack Wt LB (S) Poids (lb) (S)	Pack Wt KG Poids (kg)	Cubic Ft Pi3	Pack Contenu	List Price Liste des prix
WM-PS028-BL-RYC	28 Qt / 26 L Waste Basket, Blue/ Panier à déchets 28 pts / 26 L, bleu	27.18	10.06	2.62	10	\$ 20.55
WM-PS038-BL-RYC	38 Qt / 36 L Waste Basket, Blue / Panier à déchets 38 pts / 36 L, bleu	28.79	13.06	3.88	10	\$ 23.88

RECYCLE BINS

SADDLE TOTE

Use this small saddle tote on almost any recycle bin to separate and collect secondary materials such as waste, organics or batteries.

FOURRE-TOUT

Utilisez ce petit fourre-tout sur presque n'importe quel bac pour séparer les déchets, les matières organiques ou les batteries.



5 GALLON UNDER DESK RECYCLE BIN

This compact recycle bin is perfect to use in small spaces.

BAC DE RECYCLAGE DE BUREAU 5 GALLONS

Ce bac compact est parfait pour les petits espaces.



KITCHEN FOOD WASTE CONTAINER / CONTENANT DE DÉCHET DE CUISINE



M2 Code Code M2	Description	Pack Wt LB (S) Poids (lb) (S)	Pack Wt KG Poids (kg)	Cubic Ft Pi3	Pack Contenu	List Price Liste des prix
RYC-0311	4L / 1 Gal Saddle Tote - Black / Fourre-Tout - 4L / 1 gal - noir				1	\$ 9.95
RYC-0517	5 Gallon/(17L) Under Desk Recycle Bin / 5 gallons / 17 litres - Bac de recyclage sous le comptoir				1	\$ 20.42
RYC-0108-BE-GN	Kitchen Food Waste Container-8L/2.11US Gal. Beige & Green 2.11 gallons US / 8 litres - Contenant de déchet de cuisine beige & vert				1	\$ 20.19

STATIONARY BINS / BACS STATIONNAIRES

16 GALLON CURBSIDE RECYCLE BIN / BAC DE RECYCLAGE SÉLECTIF 16 GALLONS

22 GALLON CURBSIDE RECYCLE BIN / BAC DE RECYCLAGE SÉLECTIF 22 GALLONS

16 GALLON CURBSIDE RECYCLE BIN LID / 16 COUVERT POUR BAC DE RECYCLAGE SÉLECTIF 16 & 22 GALLONS

Lids fit both 16 and 22 Gal Containers /

Les couvercles conviennent aux conteneurs de 16 et 22 gallons

3 Decals Included / 3 décalcomanies incluses



M2 Code Code M2	Description	Pack Wt LB (S) Poids (lb) (S)	Pack Wt KG Poids (kg)	Cubic Ft Pi3	Pack Contenu	List Price Liste des prix
RYC-1660	16 Gallon Curbside Recycle Bin / 16 gallons - bac de recyclage sélectif				1	\$ 32.50
RYC-2290	22 Gallon Curbside Recycle Bin / 22 gallons - bac de recyclage sélectif				1	\$39.92
RYC-1622-L	16 and 22 Gallon Curbside Recycle Bin Lid only / 16 et 22 gallons - couvert pour bac de recyclage sélectif				1	\$16.26
RYC-2290-L	16 and 22 Gal. Curbside Recycle Lid Only with Hole for Bottles and Cans / 16 et 22 Gal. Couvercle de recyclage en bordure de rue seulement avec trou pour bouteilles et canettes				1	\$ 31.80

STACK & NEST RECYCLE BINS / BAC DE RECYCLAGE SÉLECTIF

12 GALLON STACK AND NEST RECYCLE BIN

A stackable recycle bin designed for sorting and storing recyclables. vertical storage design uses minimal floor space while maximizing capacity. Made from 100% high density polyethylene and BPA free.

BAC DE RECYCLAGE SÉLECTIF 22 GALLONS

Un bac empilable conçu pour le tri et le stockage des matières recyclables. La conception de stockage vertical utilise un minimum d'espace au sol tout en maximisant la capacité. Fabriqué à partir de 100% de polyéthylène haute densité et sans BPA.



M2 Code Code M2	Description	Pack Wt LB (S) Poids (lb) (S)	Pack Wt KG Poids (kg)	Cubic Ft Pi3	Pack Contenu	List Price Liste des prix
RYC-1248	12 Gallon (48L) Stack and Nest Recycle Bin / 12 gallons / 48 litres - Bac de recyclage à empiler et imbriquer				1	\$33.61



STEP-ON GARBAGE CANS / POUBELLE A PÉDALE

STEP-ON CANS ARE STRONG AND DURABLE –
TIGHT FIT LID KEEPS ODOUR CONTAINED

POUBELLES STEP-ON-CAN SONT FORT ET DURABLE
– AVEC UNE COUVERCLE QUI FERME SERRÉ POUR
EMPECHER LES ODEURS DE S ÉCHAPPER



M2 Code Code M2	Description	Pack Wt LB (S) Poids (lb) (S)	Pack Wt KG Poids (kg)	Cubic Ft Pi3	Pack Contenu	List Price Liste des prix
WM-ST3008	30L / 8 Gal. Step-On Garbage Can - Plastic - Grey / Poubelle a pédale 30L /8 Gal - Plastique - Gris				4/1	\$129.62
WM-ST4512	45L / 12 Gal. Step-On Garbage Can - Plastic - Grey / Poubelle a pédale 45L /12 Gal - Plastique - Gris				3/1	\$ 155.54
WM-ST6818	68L / 18 Gal. Step-On Garbage Can - Plastic - Grey / Poubelle a pédale 68L /18 Gal - Plastique - Gris				3/1	\$ 232.31

WHEELER GARBAGE CANS / CONTENANT À DÉCHET SUR ROUES

Two Wheeled Garbage cans make it quick and easy to collect and transport waste. Made of commercial grade injection molded HDPE plastic makes them extremely durable and prevents cracking and denting. Ideal for indoor and outdoor uses.

Les poubelles à deux roues, facilitent la collecte et le transport des déchets. Fabriqués en plastique HDPE moulé par injection de qualité commerciale, elles sont extrêmement durables et évitent les fissures et les bosselures. Idéales pour les utilisations intérieures ou extérieures.

13 GALLON CURBSIDE ORGANICS BIN

A manual organics collection container designed for household organics collection.

Made from 100% high density polyethylene, this container is BPA Free and easy to clean. Designed with the most durable wheels on the market, larger collection handles and a taller design, collection.

FONDEUR DE GLACE / BAC DE NOURRITURE POUR ANIMAUX

Un bac manuel de collecte de matières organiques conçu spécialement pour cet usage. Fabriqué à partir de polyéthylène haute densité 100%. ce bac est sans BPA et facile à nettoyer. Conçu avec les roues les plus durables sur le marché, des poignées de collection plus grandes et un design plus haut.



M2 Code Code M2	Description	Pack Wt LB (S) Poids (lb) (S)	Pack Wt KG Poids (kg)	Cubic Ft Pi3	Pack Contenu	List Price Liste des prix
WM-TW12032	120L / 32 Gal. 2 Wheeler Garbage Can - Plastic - Grey / Poubelle a pédale 120L /32 Gal - Plastique - Gris				3/1	\$ 310.93
WM-TW24064	240L / 64 Gal. 2 Wheeler Plastic Garbage Can - Plastic - Grey / Poubelle a pédale 240L /64 Gal - Plastique - Gris				4/1	\$ 410.43
WM-TW20855	208L/55 Gal Rollout Garbage Can - Grey				4/1	\$ 410.43
RYC-1360-GN	60 Litre / 13 U.S. Gallon Food Waste Container with Lock - Green 60 litres / 60 gallons - Conteneur à déchets alimentaire avec serrure - vert				1	\$ 97.15

M2 GALAXY LOBBY DUSTPAN / PROMENOIR M2 GALAXY

GALAXY LOBBY DUST PAN

- Redesigned Plastic Lobby Dustpan
- Hang-up cap handle for easy storage
- Easy to release dirt
- Lightweight design

PROMENOIR VERTICAUX - GALAXY

- Promenoir vertical de plastique redessiné
- Poignée de suspension pour un entreposage facile
- Facile à vider
- Conception légère

Sure-Lock Hinge /
Sure Lock Charnière



M2 Code Code M2	Description	Pack Wt LB (S) Poids (lb) (S)	Pack Wt KG Poids (kg)	Cubic Ft Pi3	Pack Contenu	List Price Liste des prix
DP-L700	Lobby dust pan with foldable handle / Promenoir avec manche repliable				16	\$ 7.14
DP-L800	Galaxy Plastic Lobby Dust Pan with Handle (Broom not included) / Promenoir vertical en plastique avec manche Galaxy (balai non compris)	2.4	1	2.7	6	\$ 26.52
DP-L800-CH	Galaxy Plastic Lobby Dust Pan with Coloured 30" Fiberglass Handle				6	\$ 44.91
DP-L800-PL	Galaxy Lobby dust pan with foldable handle / Promenoir avec manche repliable Galaxy				16	\$ 36.45
DP-L802	Galaxy Combo: Plastic Pan, Angle Broom and Handle / Ensemble promenoir vertical en plastique, balai en angle et manche Galaxy	4.2	2	2.7	6	\$ 40.39
DP-L950	Jumbo Lobby Dustpan 13 1/2" x 14" Deep / Promenoir vertical géant 13 1/2" x 14" profondeur				10	\$ 45.64
DP-L810	Metal Lobby Dustpan with Lid / Porte-poussière d'entrée en métal avec couvert	24	11	4	6/1	\$ 53.43



M2 Code Code M2	Description	Pack Wt LB (S) Poids (lb) (S)	Pack Wt KG Poids (kg)	Cubic Ft Pi3	Pack Contenu	List Price Liste des prix
DP-L830	Galaxy Plastic Lobby Dustpan - 2 Piece Handle - All-In-One Box /				6	\$ 29.43
DP-L831	Galaxy Combo Plastic Lobby Dustpan, with Angle Broom - 2 Piece Handle - All-In-One Box /				6	\$ 29.43
BA-3036	8"/20 cm Angle Broom with 36"/91cm Handle / Balai en angle, 8 po / 20 cm, manche de 36 po/91 cm	30	13.5	1.5	24/12	\$ 8.01



METAL & PLASTIC DUSTPANS / PROMENOIR EN MÉTAL AVEC COUVERT

The sharp edge of our plastic and metal dustpans makes them ideal for sweeping fine particles without leaving dirt on the floor.

Avec leur arête vive, les porte-poussière en plastique et en métal sont parfaits pour balayer les particules fines et ramasser toute la poussière sur le sol.

**COUNTER DUSTPAN SET
ENSEMBLE PORTE-POUSSIÈRE ET
BROSSE-COMPTOIR**



**9" CLIP-ON
CLIP-ON, 9 PO**



**9" CLIP-ON -BB
CLIP-ON, 9 PO -BB**



**13" PLASTIC CLIP-ON
PLASTIQUE CLIP-ON, 13 PO**



**12" PLASTIC
PLASTIQUE, 12 PO**



M2 Code Code M2	Description	Pack Wt LB (S) Poids (lb) (S)	Pack Wt KG Poids (kg)	Cubic Ft Pi3	Pack Contenu	List Price Liste des prix
BR-CO206D	Counter Brush with Dust Pan / Ensemble porte-poussière et brosse-comptoir	1		1.7	24/12	\$ 5.53
DP-H509	9" Clip-on Medium Dust Pan – White / Porte-poussière "Clip-on", 9 po, medium - blanc				24/12	\$ 3.95
DP-H509-BB	9" Clip-on Medium Dust Pan – Baby Blue /				24/12	\$ 3.95
DP-H514-BK	14" Clip-on Dust Pan – Large with Shark Teeth - Black				24/12	\$ 6.09
DP-H614	12" Plastic Dustpan – Black / Porte-poussière en plastique, 12 po, noir	7	3	1	12	\$ 6.06

**12" METAL
MÉTAL, 12 PO**



**16" X-LARGE METAL
EXTRA GRAND EN MÉTAL, 16 PO**



LITTER SCOOP WITH HEAVY DUTY BAG ANT

- Heavy duty with light weight frame for picking up debris
- Strong durable bag

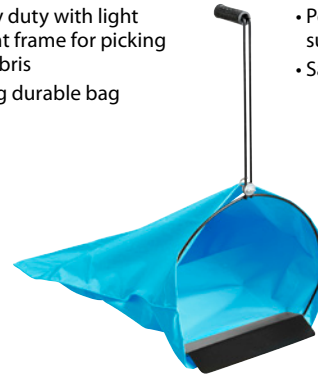

PELLE À LITIÈRE AVEC SAC TRÈS RÉSISTANT

- Pelle à litière très résistante avec support léger
- Sac solide et durable



LITTER PICK-UPS / PINCE À DÉCHETS



M2 Code Code M2	Description	Pack Wt LB (S) Poids (lb) (S)	Pack Wt KG Poids (kg)	Cubic Ft Pi3	Pack Contenu	List Price Liste des prix
DP-H715	12" Metal Dustpan – Black / Porte-poussière en métal, 12 po, noir	15	7	1	12	\$ 10.81
DP-H716	16" Metal Dustpan – Black / Porte-poussière en métal, 16 po, noir	15	7	1	12	\$ 15.71
LS-1171	Litter Scoop Complete with Heavy Duty Bag / Pelle à litière avec sac très résistant	3	1.5		1	\$ 47.44
LS-1172	Litter Scoop – Bag Only / Sac pour pelle à litière	1.1	5		1	\$ 19.37
LS-1173	Litter Scoop Frame Only / Cadre pour pelle à litière seulement	3	1.3		1	\$ 31.94
LS-2100	Litter Picker-40"/100cm / Pique-ordures-40"/100cm	3	1.5		10/1	\$ 68.79
WS-LS9537	Litter Spike - Aluminum Handle - 37.4" / 95cm / Pic à litière poignée en Aluminium - 37.4" / 95 cm	3	1.5		10/1	\$ 26.57

PROFESSIONAL – MAGNETIC BROOMS - JUPITER - FLAT BLOCK BALAIS MAGNÉTIQUES PROFESSIONNEL - JUPITER - BLOC PLAT

JUPITER- KITCHEN BROOM /

- Jupiter Large elegant style upright broom is heavily filled for sweeping fine particles on smooth hardwood floors. Includes a choice of 48" handles.
- Flat block to give more surface cleaning

BALAI DE CUISINE - JUPITER

- Le large et élégant balai droit Jupiter est très rempli pour ramasser les fines particules sur les surfaces lisses des planchers de bois. Comprend un choix de 48 po poignées.
- Bloc plat pour donner plus de nettoyage de surface



M2 Code Code M2	Description	Pack Wt LB (S) Poids (lb) (S)	Pack Wt KG Poids (kg)	Cubic Ft Pi3	Pack Contenu	List Price Liste des prix
BM-4400	Jupiter Premium Large Indoor Flat Mag Broom with 48" Metal Handle - Blue / Balai Jupiter premium avec manche en métal 48" - bleu				10	\$ 15.42
BM-4400BK	Jupiter Premium Large Indoor Flat Mag Broom with 48" Metal Handle - Black / Balai Jupiter premium avec manche en métal 48" - noir				10	\$ 15.42
BM-4420	Jupiter Premium Lrg Indoor Flat Mag Broom with 48" Wood Handle - Blue / Balai Jupiter premium avec manche en bois 48" - bleu				10	\$ 18.64



M2 Code Code M2	Description	Pack Wt LB (S) Poids (lb) (S)	Pack Wt KG Poids (kg)	Cubic Ft Pi3	Pack Contenu	List Price Liste des prix
BM-4410	Jupiter Premium Large Indoor Flat Mag Broom with Heavy Duty 48" Metal Handle - Blue / Balai Jupiter premium avec manche en métal 48" - bleu				10	\$ 21.21
BM-4400-HO	Jupiter Premium Large Indoor Flat Mag Broom - Head Only - Blue / Balai Jupiter premium - tête seulement- bleu				24	\$ 13.18
BM-4400-HO-RD	Jupiter Premium Large Indoor Flat Mag Broom - Head Only - Red / Balai Jupiter premium - tête seulement- rouge				24	\$ 13.18
BM-4500-HO-BK	Jupiter Premium Large Indoor Flat Mag Broom - Head Only - Black / Balai Jupiter premium - tête seulement - noir				24	\$ 13.18



RT-MB-9237	Magnetic Broom / Balai magnétique				6	\$ 12.35
------------	-----------------------------------	--	--	--	---	----------



KITCHEN – MAGNETIC BROOMS / - VENUS BALAIS MAGNÉTIQUES DE CUISINE - VENUS

VENUS - LARGE CURVED

Flagged bristles are ideal for fine sweeping fine particles of dirt on smooth surfaces indoors

VENUS – GRANDE COURBE

Les soies fleurées sont idéales pour balayer les fines particules de salissures sur les surfaces intérieures lisses



BM-4200-RD



BM-4200-BL



BM-4200-W

M2 Code Code M2	Description	Pack Wt LB (S) Poids (lb) (S)	Pack Wt KG Poids (kg)	Cubic Ft Pi3	Pack Contenu	List Price Liste des prix
BM-4200-RD	Venus – Large Indoor Curved Magnetic Broom with 48” White metal Handle-Red Grand balai-brosse intérieur magnétique Venus, grande courbe, manche de métal blanc 48 po- Etui Mixte - rouge	8.4	3.8	1.1	10	\$ 11.17
BM-4200-BL	Venus – Large Indoor Curved Magnetic Broom with 48” White metal Handle - Blue Grand balai-brosse intérieur magnétique Venus, grande courbe, manche de métal blanc 48 po- Etui Mixte - bleu	8.4	3.8	1.1	10	\$ 11.17
BM-4200-W	Venus –Large Indoor Magnetic Broom with 48” Wood Handle / Venus - grand, intérieur balai magnétique avec manche en bois 48”	8.4	3.8	1.1	10	\$ 15.16



BM-4250-BK



BM-4250-BL



BM-4250-RD



BM-4260



BM-4270

Tall Boy / Grand

Stiff Sweep / Balayage robuste

M2 Code Code M2	Description	Pack Wt LB (S) Poids (lb) (S)	Pack Wt KG Poids (kg)	Cubic Ft Pi3	Pack Contenu	List Price Liste des prix
BM-4250-BK	Venus – Large Indoor Curved Magnetic Broom – Head Only - Black / Grand balai-brosse intérieur magnétique Venus, grande courbe, tête seulement - noir	8.4	3.8	1.1	24	\$ 9.51
BM-4250-BL	Venus – Large Indoor Curved Magnetic Broom – Head Only - Blue / Grand balai-brosse intérieur magnétique Venus, grande courbe, tête seulement - bleu	8.4	3.8	1.1	24	\$ 9.51
BM-4250-RD	Venus – Large Indoor Curved Magnetic Broom – Head Only - Red / Grand balai-brosse intérieur magnétique Venus, grande courbe, tête seulement - rouge	8.4	3.8	1.1	24	\$ 9.51
BM-4260	Venus –Tall Boy Indoor/Outdoor Magnetic Broom with 48” White Metal Handle / Venus - grand, Intérieur/extérieur balai magnétique avec manche blanc 48” en métal	7.4	4.2	1.1	6	\$ 12.91
BM-4260-HO	Venus –Tall Boy Indoor/Outdoor Magnetic Broom - Head Only / Venus - grand, Intérieur/extérieur balai magnétique - tête seulement	7.4	4.2	1.1	16	\$ 11.25
BM-4261	Venus –Tall Boy Indoor/Outdoor Magnetic Broom with 48” Wood Handle / Venus - grand, Intérieur/extérieur balai magnétique avec manche en bois 48”	7.4	4.2	1.1	6	\$ 16.28
BM-4270	Venus Stiff Magnetic Broom with 48” White Metal Handle / Grand balai-brosse intérieur magnétique Venus, grande courbe, manche de 48 po -très raide	8.3	3.8	1	12	\$ 11.51

KITCHEN – MAGNETIC BROOMS - PLUTO & PROMO - FLAT BLOCK BALAIS MAGNÉTIQUES DE CUISINE - PLUTO ET PROMO - BLOC PLAT



BM-4300-BL



BM-4300-RD



BM-4320-BL-W

M2 Code Code M2	Description	Pack Wt LB (S) Poids (lb) (S)	Pack Wt KG Poids (kg)	Cubic Ft Pi3	Pack Contenu	List Price Liste des prix
BM-4300-BL	Pluto - Large indoor flat magnetic broom with 48” White metal handle /Grand balai-brosse intérieur magnétique Pluto, avec manche de métal blanc 48 po				10	\$ 12.84
BM-4300-RD	Pluto - Large indoor flat magnetic broom with 48” White metal handle /Grand balai-brosse intérieur magnétique Pluto, avec manche de métal blanc 48 po				10	\$ 12.84
BM-4320	Pluto - Large indoor flat magnetic broom with 48” Wood handle /Grand balai-brosse intérieur magnétique Pluto, avec manche en bois 48”	8	3.6	.8	10	\$ 15.10

KITCHEN MAGNETIC BROOMS / BALAIS MAGNÉTIQUES DE CUISINE

SATURN SCRUBBING BROOM /

- Saturn Premium Scrubbing brush has stiff fiber to aggressively scrub floor tile and grout

BALAIS POUR RÉCURAGE SATURN

- La brosse à récurer Saturn premium a des fibres raides pour nettoyer agressivement le carrelage et le coulis,

CUPID - FLAT

- Flagged bristles are ideal for fine sweeping fine particles of dirt on smooth surfaces indoors

CUPID - PLAT

- Les poils marqués sont idéals pour balayer les fines particules de salissures sur les surfaces intérieures lisses



M2 Code Code M2	Description	Pack Wt LB (S) Poids (lb) (S)	Pack Wt KG Poids (kg)	Cubic Ft Pi3	Pack Contenu	List Price Liste des prix
BM-4500	Saturn 12" Marine Deck Scrubbing Brush White Short Stiff Fibers with 48" Metal Handle Saturn brosse a récurer pour plancher 12 pouces avec poil white rigide court rouge et blanc/manche 48 pouces en metal				12	\$ 16.71
BM-4500-BL	Saturn 12" Marine Deck Scrubbing Brush Bluee Short Stiff Fibers with 48" Metal Handle Saturn brosse a récurer pour plancher 12 pouces avec poil bleu rigide court rouge et blanc/manche 48 pouces en metal				10	\$ 16.71
BM-4100	Cupid Flat Indoor Magnetic Broom with 48" Handle / Balai-brosse intérieur Cupid, plat, manche de 48 po	8.5	4	1	24	\$ 6.74
BM-4600-BL	Promo Indoor Magnetic Broom - Blue/Blue & Black with 48" Metal Handle /				10	\$ 9.57

RIGHT ANGLE – MAGNETIC BROOMS / - VORTEX BALAIS MAGNÉTIQUES ANDLE DROIT - VORTEX

VORTEX KITCHEN / OFFICE ANGLE BROOM

- Ideal for indoor/outdoor clean-up
- Angled design helps to sweep in corners or along walls
- Not affected by water

BALAI EN ANGLE DE CUISINE ET DE BUREAU VORTEX

- Idéal pour le ménage intérieur et extérieur
- Permet de nettoyer facilement le long des murs et dans les coins en raison de la conception de son angle
- Résistant à l'eau

VORTEX ANGLE - HEAVY DUTY – STIFF FIBER / BALAI EN ANGLE VORTEX, FIBRES RAIDES

Soft Sweep / balayage doux

VORTEX ANGLE BROOM / BALAI EN ANGLE VORTEX

Vortex angle long fibre
Angle vortex fibres longues

Stiff Sweep /
Balayage robuste



M2 Code Code M2	Description	Pack Wt LB (S) Poids (lb) (S)	Pack Wt KG Poids (kg)	Cubic Ft Pi3	Pack Contenu	List Price Liste des prix
BA-3200	12" /30cm Vortex Angle Broom short fiber with 48" / 121 cm Handle - Red Block - Black Bristles 12" /30cm Balai en angle Vortex, manche de 48 po / 121 cm	13.6	6		12	\$ 9.16
BA-3200-1W	12" /30cm Vortex Angle Broom short fiber with 48" / 121 cm Wood Handle - Baby Blue - Grey Bristles 12" /30cm Balai en angle Vortex, manche de 48 po / 121 cm	13.6	6		12	\$ 14.31
BA-3220	12" /30cm Vortex Angle Broom with 48" / 121 cm Handle – Long Fibre 12" /30cm Balai en angle Vortex, manche de 48 po / 121 cm, fibres longues	13.6	6.4	1	10	\$ 11.80
BA-3250	12" /30cm Vortex Angle Broom with 48" Heavy Duty Handle / 121 cm Handle – Stiff/Long Fiber / 12" /30cm Balai en angle Vortex, avec manche très résistant de 48 po / 121 cm, fibres raides / fibres longues	17	7.6		6	\$ 19.65
BA-3250-2	12" /30cm Vortex Heavy Duty Angle Broom with 7/8" - 48" Black Handle / 121 cm / 12" /30cm Balai en angle Vortex, avec manche très résistant de 7/8" 48 po / 121 cm, noir	17	7.6		12	\$ 13.10



MAGNETIC ANGLE BROOMS / BALAIS MAGNÉTIQUES EN ANGLE

SMALL ANGLE

- Ideal for indoor/outdoor clean-up
- Angled design helps to sweep in corners or along walls
- Not affected by water

PETIT BALAI EN ANGLE

- Idéal pour le ménage intérieur et extérieur
- Permet de nettoyer facilement le long des murs et dans les coins en raison de la conception de son angle • Résistant à l'eau

LARGE ANGLE BROOM

- Ideal for indoor/outdoor clean-up
- Large angled design helps to sweep in corners or along walls
- Not affected by water

GRAND BALAI EN ANGLE

- Idéal pour le ménage intérieur et extérieur
- Permet de nettoyer facilement le long des murs et dans les coins en raison de la largeur de son angle • Résistant à l'eau



M2 Code Code M2	Description	Pack Wt LB (S) Poids (lb) (S)	Pack Wt KG Poids (kg)	Cubic Ft Pi3	Pack Contenu	List Price Liste des prix
BA-9900	9"/23 cm Mars Small Angle Broom with 48"/121 cm Handle / Petit Mars balai en angle, 9 po cm, manche métallique de 48 po /121 cm	8.5	4	.8	24	\$ 9.38
BA-3036	9"/23 cm Mars Small Angle Broom with 36"/91 cm Handle / Balai en angle, 9 po / 23 cm, manche de 36 po/91 cm	30	13.5	1.5	12/24	\$ 8.01
BA-3036-HO	9"/23 cm Mars Small Angle Broom - Head Only / Balai Mars en angle, 9 po / 23 cm	30	13.5	1.5	48	\$ 7.44
BA-9708	9"/23 cm Mars Angle Broom Blue/Black with 48" Handle				12	\$ 7.30
BA-9708-RD	10"/25 cm Mars Angle Broom Red/Black with 48" Handle				12	\$ 7.30
BA-9708-HO	10"/25 cm Mars Angle Broom Blue/Black - Head Only				12	\$ 5.69
BA-9700	10"/25 cm Mars Angle Broom Blue/Black with 48" Handle				12	\$ 9.82
BA-9700-RD	10"/25 cm Mars Angle Broom Red/Black with 48" Handle				12	\$ 9.82
BA-9700-HO	10"/25 cm Mars Angle Broom Blue/Black - Head Only				12	\$ 7.86
BA-9800	13"/33 cm Large Angle Broom with 48" Handle /				12	\$ 14.30

ANGLE BROOM & DUSTPAN COMBO / ENSEMBLE DE BALAI EN ANGLE ET PORTE-POUSSIÈRE

MARS – 10" small angle broom with 10" clip-on dustpan
Balai en angle Mars
10" et porte-poussière clip-on 10"

MARS – 12" Medium angle broom with 13" clip-on dustpan
Balai en angle Mars
12" et porte-poussière clip-on 13"



BA-9708-D	10" / 25 cm Small Mars Angle Broom with 48"/121 cm Handle and 10" / 25 cm Clip-On dust Pan – Blue/Black / Balai 10 po / 25 cm moyen en angle Mars bleu et noir avec manche 48 po/121 cm et porte-poussière clippé	12	\$ 17.05
BA-9700-D	12" Medium Mars Angle Broom with 48"/121 cm Handle and 13"/33 cm Clip-On dust Pan – Blue/Black / Balai 12"/30 cm moyen en angle Mars bleu et noir avec manche 48 po/121 cm et porte-poussière clippé	12	\$ 18.18
RT-DB-9338	Dustpan & Angle Broom / Balai en angle et porte-poussière	6	\$ 17.31

HERCULES – OUR NEWEST HEAVY DUTY INDUSTRIAL BROOM / HERCULES, LE DERNIER NÉ DE NOS BALAIS INDUSTRIELS EXTRA ROBUSTES

INDOOR / OUTDOOR MAGNETIC BROOM

- Ideal for indoor/outdoor clean-up
- Easy to clean
- Not affected by water

BALAI MAGNÉTIQUE INTÉRIEUR / EXTÉRIEUR

- Idéal pour le ménage intérieur et extérieur
- Facile à nettoyer
- Résistant à l'eau

9" / 22.8 CM DuoAngle Thread Broom / Balai fileté deux angles 9" / 22.8 cm

- Converts right angle broom into an upright
- Convertit le balai à angle droit en un montant

NEW SIZE / NOUVELLE TAILLE



10" / 25 cm Block /
Bloc 10"/25 cm



Dustpan with rubber edge /
Ramasse-poussière avec
rebord en caoutchouc



COLOUR CODE
SYSTEM
SYSTÈME
DE CODE
DE COULEUR



BA-8306BK-48

M2 Code Code M2	Description	Pack Wt LB (S) Poids (lb) (S)	Pack Wt KG Poids (kg)	Cubic Ft Pi3	Pack Contenu	List Price Liste des prix
BA-3000	16"/40.5 cm Large Hercules Industrial Angle Broom / Grand balai industriel en angle - Hercules, 16 po/40.5 cm	12	5.5	2	6	\$ 20.96
BA-3001	16"/40.5 cm Large Industrial Angle Broom including Dustpan / Grand balai industriel en angle, 14 po/36 cm, avec ramasse-poussière	15	7	3	4	\$ 24.74
BA-8306-BK	9" / 22.8 cm Large Angled Broom - DuoAngle Thread - Block Only - Black / 9" / 22.8 cm Large balai en angle - deux angles fileté, bloc seulement - noir				12	\$ 15.34
BA-8306-GN	9" / 22.8 cm Large Angled Broom - DuoAngle Thread - Block Only - Green / 9" / 22.8 cm Large balai en angle - deux angles fileté, bloc seulement - vert				12	\$ 15.34
BA-8306-BL	9" / 22.8 cm Large Angled Broom - DuoAngle Thread - Block Only - Blue / 9" / 22.8 cm Large balai en angle - deux angles fileté, bloc seulement - bleu				12	\$ 15.34
BA-8306-RD	9" / 22.8 cm Large Angled Broom - DuoAngle Thread - Block Only - Red / 9" / 22.8 cm Large balai en angle - deux angles fileté, bloc seulement - rouge				12	\$ 15.34
BA-8306-YE	9" / 22.8 cm Large Angled Broom - DuoAngle Thread - Block Only - Yellow / 9" / 22.8 cm Large balai en angle - deux angles fileté, bloc seulement - jaune				12	\$ 15.34
BA-8306BK-48	9" / 22.8 cm Large Angled Broom - DuoAngle Thread with 48" Metal Handle - Black / 9" / 22.8 cm Large balai en angle - deux angles fileté, bloc seulement - noir				6	\$ 18.73

TRACK & SWITCH BROOM / BALAI FERROVIAIRE



PREVENT WINTER HAZARDS WITH M2'S TRACK & SWITCH BROOM

PRÉVENIR LES RISQUES DE L'HIVER AVEC LE BALAI FERROVIAIRE M2

Ideal for ice build-up, road and rail maintenance and construction

Idéal pour l'accumulation de glace, l'entretien et la construction de route et de rail



NO CHISEL
PAS DE CISEAU



BT-112	Track/Switch Industrial Broom with Heavy Duty Forged Chisel / Balai ferroviaire en polypropylène garni de fibres rigides brunes avec large ciseau de métal forgé	17.2	7.8	1.9	6/1	\$ 55.411
BT-112-NC	Track/Switch Industrial Broom - No Chisel / Balai ferroviaire industriel/ sans ciseau	17.2	7.8	1.9	6/1	\$ 72.20
BT-113	Industrial Broom with 48" Handle - Stiff Flagged Fibers - Yellow / Balai ferroviaire industriel - jaune	12.1	5.5	1.9	6/1	\$ 36.44
BT-115	Industrial Fire Broom with 48" Stiff Palmira Fibers /	12.1	5.5	1.9	6	\$ 56.16



CORN BROOMS / BALAIS DE MAÏS

Our corn brooms are sized according to use.

From our light duty household brooms that contain mixed fibers and lighter handles to our extra strong broom designed for outdoor use which contains additional corn and cane fiber with thicker and stronger handle

Nos balais de maïs sont dimensionnés en fonction de l'utilisation.

De nos balais ménagers légers aux fibres moins nombreuses et au manche léger à nos balais d'extérieur super robustes avec des fibres de maïs et de canne supplémentaires et un manche épais et résistant.

WHISK & LOBBY BROOM
PETIT BALAI ET BALAI
D'ENTRÉE



M2 Code Code M2	Description	Pack Wt LB (S) Poids (lb) (S)	Pack Wt KG Poids (kg)	Cubic Ft Pi3	Pack Contenu	List Price Liste des prix
BC-102	Heavy duty Corn Whisk 3 String w/Metal cap / Petit balai robuste, 3 cordes, avec embout métallique	4.2	2	4	12	\$ 7.32
BC-103	Lobby Corn Broom / Balai maïs d'entrée	8.5	4	1.4	12	\$ 8.61

LIGHT DUTY INDOOR USE

POUR TRAVAUX LÉGERS UTILISATION INTÉRIEURE



BC-104	Indoor/Outdoor 5 String / Extérieur / intérieur, 5 cordes	16.5	7.5	3.5	12	\$ 13.15
BC-107	Indoor/Outdoor 6 String / Extérieur / intérieur, 6 cordes	19.5	9	4.3	12	\$ 17.40

MEDIUM TO HEAVY INDOOR / OUTDOOR USE /

POUR TRAVAUX MOYENS À LOURDS UTILISATION INTÉRIEURE ET EXTÉRIEURE



BC-500	Medium to Heavy duty 4 String 1 Wire band / Balai moyen à lourd, 4 cordes, 1 bague métallique	26.5	12	4.5	12	\$ 16.51
BC-107C	Medium to Heavy duty 3 String 1 Wire band / Balai moyen à lourd, 3 cordes, 1 bague métallique	22.7	10	4.5	12	\$ 18.56
BC-108	Medium to Heavy duty 2 String 2 Wire band / Balai moyen à lourd, 2 cordes, 2 bagues métalliques	23	10.5	4.5	12	\$ 20.03

HEAVY DUTY - EXTRA STRONG OUTDOOR USE - STIFF SWEEP

EXTRA ROBUSTE UTILISATION EXTÉRIEURE



PLASTIC HOUSEHOLD CORN BROOM



BC-110	Heavy duty stiff 1 String 3 Wire band W/Cane / Balai robuste avec fibres de canne, 1 corde, 3 bagues métalliques	26.6	12	5.5	12	\$ 22.27
BC-101	Plastic Household Corn Broom - Head Only - Takes Threaded Handle					\$ 19.82

DECK BRUSHES / BROSSES DE PONT

CARPET BRUSH BROSSE À TAPIS

- A small natural fiber deck/carpet brush for application of shampoo and pre-spray on rugs and delicate fibres
- Petite brosse de pont / à tapis en fibres naturelles pour l'application de shampooing et la pré-vaporisation des tapis et des fibres délicates



CARPET BRUSH - POLY STIFF FIBER BROSSE A TAPIS-FIBRE RIGIDE EN POLY

Refer to Page -----
for Threaded and Tapered Handles

Se référer à la page ----- pour les man-
ches filetés et effilés



UTILITY DECK SCRUB - NATURAL FIBER - SOFT SCRUB BROSSES DE PONT GARNIE DE FIBRES NATURELLES - BROSSAGE DOUX

- 11"/30 cm utility scrub with heavy duty squeegee which allows for quick water removal
- Brosse de pont de 11 po/30 cm avec un racloir robuste pour enlever rapidement l'eau



M2 Code Code M2	Description	Pack Wt LB (S) Poids (lb) (S)	Pack Wt KG Poids (kg)	Cubic Ft Pi3	Pack Contenu	List Price Liste des prix
BCA-228WT	8"/20 cm Carpet Brush Wood Block – White Natural Fiber / Brosse à tapis de 8 po/20 cm garnie de fibres naturelles blanches, bloc en bois	12	5	.5	12	\$ 7.07
BCA-228P	8"/20 cm Carpet Brush Wood Block – Poly Stiff Fiber / Brosse à tapis de 8 po/20 cm	12	5	.5	12	\$ 6.64
BCA-226WT	11"/30 cm Utility Deck Scrub & Squeegee – White Natural Fiber / Brosse de pont de 11 po/30 cm garnie de fibres naturelles blanches et racloir	12	5	.5	20	\$ 9.99

UTILITY DECK SCRUB - WHITE POLYPRO BROSSE DE PONT GARNIE DE FIBRES DE POLYPROPYLÈNE BLANC

- 11"/30 cm utility scrub with heavy duty squeegee which allows for quick water removal. Acid resistant
- Brosse de pont de 11 po/30 cm avec un racloir robuste pour enlever rapidement l'eau. Résistant aux acides.



Refer to Page-----
for Threaded and Tapered Handles
Se référer à la page ----- pour les man-
ches filetés et effilés



UTILITY DECK SCRUB - BASSINE FIBER / HEAVY SCRUB BROSSE DE PONT GARNIE DE FIBRES NATURELLES BASSINE - BROSSAGE ROBUSTE

- 11"/30 cm utility scrub with heavy duty squeegee which allows for quick water removal
- Brosse de pont de 11po/30 cm avec un racloir robuste pour enlever rapidement l'eau

BD-226PL	11"/30 cm Utility Deck Scrub & Squeegee – White Poly Fiber / Brosse de pont de 11 po garnie de fibres polyester blanches et racloir	20	9	1	20	\$ 11.39
BD-226BA	11"/30 cm Utility Deck Scrub & Squeegee – Bassine Fiber / Brosse de pont de 11 po/30 cm garnie de fibres naturelles bassine et racloir	21	9.5	1	20	\$ 9.60
BD-226BA-2	11"/30 cm Utility Deck Scrub without Squeegee – Palmira/Bassine Fiber / Brosse de pont de 11 po/30 cm garnie de fibres naturelles bassine ??????????????	21	9.5	1	20	\$ 9.43

BULLDOG POT/RIG/UTILITY - UNION FIBER - CONNECTEUR BULLDOG POUR CHAUDRON/ CASSEROLE/UTILITAIRE – FIBRE UNION



BD-BD1705	Bulldog Bolt Deck Scrub Brush-Union Fiber 2.5w x 9"L /3/4 Thickness block trim length 2.5" (6.3 cm)/ Brosse a recurer les ponts, "Bulldog Bolt", fibres union sur bloc 2,5" Larg. x 9" Long. x 3/4" epaisseur, longueur des fibres 2,5 po	12	5	.5	12/2	\$ 13.20
BD-BD1601	Bulldog Bolt Round scrub brush- Union fiber Block 5-1/4" (13.3 cm) round trim length 2.5" (6.3 cm) / Brosse à récurer ronde, "Bulldog Bolt", fibres union sur bloc rond 5 1/4" (13.3 cm), longueur des fibres 2,5 po (6.3 cm)	10	5	1.3	12	\$ 16.50
PB-BD700-60	Bulldog Connector and 60"x1/18 (152cm x 3cm) Tapered handle Connecteur Bulldog avec manche 60"x1/18 bout fuselé				4	\$ 16.68
BR-TR1253	Black Tampico Tar Applicator Brush 7"x2.5" X 1.1" Wood Block/Tapered Handle sold separately				12	\$ 12.26



UTILTY BRUSHES / BROSSES UTILITAIRES

8" SCRUBBING BRUSH STIFF W/THREADED HOLE PLASTIC BLOCK

- 2" long Black Stiff Fiber
- Recommended for general cleaning services and takes a threaded handle

8" Brosse Rigide avec Trou Fileté, Bloc en Plastique

- Fibre rigide noire longueur 2"
- Recommandé pour les services généraux de nettoyage, accepte un manche fileté

8" WHITE TAMPICO SCRUBBING BRUSH WITH THREADED HOLE –

- 2" long White tampico fiber
- Ideal for window washing or applying waterproofing - takes a threaded handle

8" Brosse à Récurer en Fibre Tampico Blanche avec Trou Fileté

- 8" Brosse à récurer en fibre tampico
- 8" Brosse à récurer en fibre tampico blanche avec trou fileté - bloc en plastique



M2 Code Code M2	Description	Pack Wt LB (S) Poids (lb) (S)	Pack Wt KG Poids (kg)	Cubic Ft Pi3	Pack Contenu	List Price Liste des prix
BD-1508	8"/20 cm Scrubbing Brush Stiff with Threaded Hole – Plastic Block / 8"/20 cm Brosse rigide avec trou fileté - bloc en plastique				16	\$ 7.42
BD-1508-348W	8"/20 cm Scrubbing Brush with Threaded Hole – Plastic Block and 48" Wood Handle / 8"/20 cm Brosse à récurer avec trou fileté - bloc en plastique et 48 po				16	\$ 1.87
BD-1608	8"/20 cm White Tampico Scrubbing Brush with Threaded Hole – Plastic Block / 8"/20 cm Brosse à récurer en fibre Tampico blanche avec trou fileté - bloc en plastique				16	\$11.48

10" SCRUBBING BRUSH STIFF W/THREADED HOLE PLASTIC BLOCK

- 2" long Red Stiff Fiber
- Recommended for general cleaning services takes a threaded handle

10" Brosse Rigide avec Trou Fileté, Bloc en Plastique

- Fibre rigide noire longueur 2"
- Recommandé pour les services généraux de nettoyage, accepte un manche fileté

10" WHITE TAMPICO SCRUBBING BRUSH WITH THREADED HOLE – PLASTIC BLOCK

- 2" long White tampico fiber
- Ideal for window washing or applying waterproofing - takes a threaded handle

10" Brosse à Récurer en Fibre Tampico Blanche avec Trou Fileté - Bloc en Plastique

- Fibre blanche Tampico longueur 2"
- Idéal pour le lavage des vitres ou applications étanches - accepte un manche fileté



BD-1110	10" / 25 cm Scrubbing Brush Stiff with Threaded Hole – Plastic Block / 10" Brosse rigide avec trou fileté - bloc en plastique				12	\$ 11.38
BD-1110-M54	10" / 25 cm Scrubbing Brush with Threaded Hole – Plastic Block and 54" Metal Handle / 10" / 25 cm Brosse à récurer avec trou fileté - bloc en plastique et 54 po				4	\$ 18.43
BD-1610	10" / 25 cm White tampico Scrubbing Brush with Threaded Hole – Plastic Block / 10" / 25 cm Brosse à récurer en fibre Tampico blanche avec trou fileté - bloc en plastique				12	\$14.02

HAND SCRUB / BROsse À MAIN

POINTED SCRUB – NATURAL FIBER / SOFT SCRUB

EFFILÉE ET GARNIE DE FIBRES NATURELLES - BROSSAGE DOUX

- 9" pointed hand scrub
- Ideal for scrubbing in small tight areas
- Brosse à main effilée de 9 po
- Idéale pour récurer dans les espaces exigus

POINTED SCRUB – WHITE FIBER / HEAVY SCRUB

EFFILÉE ET GARNIE DE FIBRES DE POLYPROPYLENE BLANC - BROSSAGE ROBUSTE

- 9" pointed hand scrub
- Ideal for scrubbing in small tight areas
- Brosse à main effilée de 9 po
- Idéale pour récurer dans les espaces exigus

8" ERGONOMIC GRIP SOFT BRISTLE /

8" Brosse à Poignée Ergonomique, Poils Doux

- Soft fiber Grey 1 3/4" in length
- Ideal for washing delicate surfaces, cars and crystals
- Douce fibre gris 1 3/4" de longueur
- Idéal pour le lavage des surfaces délicates, les voitures et les cristaux



BH-229WT	9"/22 cm Pointed Hand Scrub – White Natural Fiber / Brosse à main effilée de 9 po garnie de fibres naturelles blanches	9	4	.6	20	\$ 4.09
BH-229PL	9"/22 cm Pointed Hand Scrub – White Poly Fiber / Brosse à main effilée de 9 po garnie de fibres de polypropylène blanc	9	4	.6	20	\$ 4.36
BV-3205	8"/20 cm Ergonomic Grip Soft Bristle - White Tampico / 8" Brosse à poignée ergonomique, poils doux - Tampico blanche				12	\$ 9.55

**10" ACID RESISTANT CAR/TRUCK -
PLASTIC BLOCK /
BROSSE RÉSISTANTE AUX ACIDES / AUTOMOBILE /
CAMION 10 PO.**

- Grey/White flagged fiber
- Resistant to common cleaners, detergent or acids
- Fait de fibres marqués gris et blanche.
- Résiste aux nettoyeurs communs, aux détergents et aux acides.

Brushes accept threaded handle
Refer to Page 63 Les brosses acceptent un manche fileté.
Se référer à la page 63

**8" SCRUBBING BRUSH /
BROSSE 8 PO, POILS VERTS INCLINÉ, BLOC EN PLASTIQUE**

- 8" plastic block with stiff short fibers for scrubbing tough areas
- The Polypro fibers are solvent resistant
- Bloc en plastique de 8" avec des fibres courtes rigides pour brosser les zones difficiles.
- Les fibres polypro sont résistantes aux solvants.



M2 Code Code M2	Description	Pack Wt LB (S) Poids (lb) (S)	Pack Wt KG Poids (kg)	Cubic Ft Pi3	Pack Contenu	List Price Liste des prix
BV-300AR	10" Acid Resistant Car/Truck Brush – Plastic Block – Grey/White - Flagged Fill / Brosse automobile / camion résistante aux acides, 10 po, poils inclinés gris / blancs, bloc en plastique	12	5.5	2.6	10	\$ 26.13
BV-298WH	8" Scrubbing Brush - Short Polypro Fiber - White / 8" Brosse à récurer - Fibres courtes blanches				12	\$ 25.30
BD-224UN	7" Masonry Brush Union fiber Tapered hole /				12	\$ 14.88

**WINDOW/CAR/TRUCK WASH SCRUBS /
BROSSES À VITRES / AUTOMOBILES / CAMIONS**



BW-205WTR	Window Brushes Plastic Block Round – White Natural Fiber / Brosse à vitres en plastique, fibres naturelles blanches, bloc rond	10	5	1.3	12	\$ 22.94
BW-205SFR	Window Brushes Plastic Block Round – Grey Flagged / Brosse à vitres en plastique, poils inclinés gris, bloc rond	10	5	1.3	12	\$ 22.20
BB-3615	Baseboard Corner Brush /				12	\$ 45.50

**8" CAR/TRUCK BRUSH - PLASTIC BLOCK /
BROSSE AUTOMOMILE / CAMION 8 PO**

- White Tampico fiber resistant to solvents and heat
- Ideal for commercial car or truck washes
- Fait de fibre blanche Tampico qui résiste aux solvants et à la chaleur.
- Idéale pour les voitures commerciales ou le nettoyage des camions.

**10" CAR/TRUCK BRUSH - PLASTIC BLOCK /
BROSSE AUTOMOMILE / CAMION 10 PO**

- High density green fiber fill
- Ideal for commercial car or truck washes
- Fait de fibre verte haute densité.
- Idéale pour les voitures commerciales ou pour le nettoyage des camions.

**9" CAR/TRUCK BRUSH - PLASTIC BLOCK /
BROSSE AUTOMOMILE / CAMION 9 PO**

- High density green fiber fill
- Ideal for commercial car or truck washes
- Vinyl bumper protects vehicle finishes
- Fait de fibres vertes de haute densité.
- Idéale pour les voitures commerciales ou le nettoyage des camions.
- Un butoir de vinyle protège le fini du véhicule.



BW-205WT	8" (20 cm) Car/Truck Brush – Plastic Block – White Tampico Fill / Brosse automobile / camion, 8 po (20 cm), fibres tampico blanches, bloc en plastique	8.2	3.7		12	\$ 16.06
BV-300F	10" (25.4 cm) Car/Truck Brush – Plastic Block – Green Flagged Fill / Brosse automobile / camion, 10 po (25.4 cm), poils verts inclinés, bloc en plastique	10	5.5	2.6	10	\$ 25.42
BV-301F	9" (22.8 cm) Car/Truck Brush – Plastic Block with Bumper – Green Flagged Fill / Brosse automobile / camion, 9 po (22.8 cm), poils verts inclinés, bloc en plastique avec pare choc	10	4.5	2.6	12	\$ 18.73



BI-LEVEL CAR/TRUCK WASH / BROSE À DEUX NIVEAUX - LAVAGE CAR/CAMION



STIFF / RIGIDE

YELLOW STIFF FIBER FOR MORE AGGRESSIVE SCRUBBING / FAIT DE FIBRES ROBUSTES JAUNES POUR UN BROSSAGE PLUS AGRESSIF.

GREEN DENSILY FILLED FLAGGED TIPS FOR SOFT SURFACES / FAIT DE FIBRE DENSE VERTE À POINTES MARQUÉES POUR LES SURFACES DOUCES.

Our 10" heavy duty Bi-Level Brushes come in three types of bristles which are handy for cleaning all types of surfaces and floors
It features flow through holes that allow water to be dispersed across the entire area of the brush
These brushes are great for washing trucks buses and hard to reach areas

BI-LEVEL SCRUB

SOFT / DOUCE



ACID RESISTANT / RÉISTANTE AUX ACIDES



GREY/WHITE AND ACID RESTANT FIBER FOR MULTI - PURPOSE CLEANING / FAIT DE FIBRES GRISS ET BLANCHES ET RÉISTANTE AUX ACIDES, POUR DES NETTOYAGES MULTIPLES.

Notre brosse robuste deux niveaux vient en trois types de poils qui conviennent à toutes les surfaces et planchers.
Elle dispose de 5 trous qui permettent de disperser l'eau sur toute la surface de la brosse.
Cette brosse est idéale pour laver les camions, autobus et les espaces difficiles à atteindre.

M2 Code Code M2	Description	Pack Wt LB (S) Poids (lb) (S)	Pack Wt KG Poids (kg)	Cubic Ft Pi3	Pack Contenu	List Price Liste des prix
BV-400	Bi-Level Truck Brush - Yellow - Stiff / Brosse à camion à deux niveaux - jaune - Rigide	1.6	.75	.81	12/1	\$ 33.46
BV-400-WH	Bi-Level Food Service Brush - White - Stiff /	1.6	.75	.81	12/1	\$ 35.08
BV-400-GN	Bi-Level Food Service Brush - Green - Stiff /	1.6	.75	.81	12/1	\$ 35.08
BV-400-BL	Bi-Level Food Service Brush - Blue - Stiff /	1.6	.75	.81	12/1	\$ 35.08
BV-400-RD	Bi-Level Food Service Brush - Red - Stiff /	1.6	.75	.81	12/1	\$ 35.08
BV-400-YE	Bi-Level Food Service Brush - Yellow - Stiff /	1.6	.75	.81	12/1	\$ 35.08
BV-420	Bi-Level Truck Brush - Green Flagged - Soft / Brosse à camion à deux niveaux - vert - inclinés	1.6	.75	.81	1	\$ 34.80
BV-421	Bi-Level Truck Brush - Acid Restant / Brosse à camion - Résistante aux acides	1.6	.75	.81	1	\$ 34.80

UNIVERSAL SCRUBS & GROUT BRUSH / BROSSES UNIVERSELLE ET BROSSES À COULIS



UNIVERSAL SCRUB / BROSE UNIVERSELLE

- Universal scrub brush allows you to scrub decks, walls and base boards
- Brosse universelle qui permet de brosser les ponts, les murs et les plinthes.

GROUT BRUSH

- Grout brush has a V shape bristle to help clean grout lines on a tiled floor
- Stiff chemical resistant polypro bristles allow for strong scrubbing on floors
- Accepts any acme threaded handle

BROSSE À COULIS

- Cette brosse à coulis a des poils en forme de V qui facilitent le nettoyage des lignes de coulis sur le carrelage.
- Ces poils raides résistants aux produits chimiques permettent un brossage robuste sur le plancher.
- Accepte tous les manches filetés Acme.

BR-UT60702	Universal Scrub - White Polypro Bristles / Brosse universelle Polypro - blanc	3.90	1.77	.25	12	\$ 19.81
BR-UT60709	Grout Scrub Brush (Handle not included) / Brosse à coulis (manche non inclus)	6.68	3.03	.98	12	\$ 12.82

GROUT BRUSH WITH SCRAPER / BROSE À COULIS AVEC RACLEUR

7" / 17.7 CM DETAIL BRUSH / BROSE À DÉTAILS

9" / 10.8 CM DETAIL BRUSH / BROSE À DÉTAILS

5" / 12.7 CM ROUND ERGONOMIC HAND SCRUB / BROSE À MAIN RONDE ERGONOMIQUE



FP-HS4500-BL	Grout Brush with Scraper / Brosse à coulis avec racleur	3.3	1.5	1.6	6	\$ 23.88
FP-HS4012-BL	7" / 17.7 cm Detail Brush / 7" / 17.7 cm Brosse à détails	.88	.40	.41	6	\$ 7.11
FP-HS4022-BL	9" / 22.8 cm Detail Brush / 9" / 22.8 cm Brosse à détails	1.1	.50	.46	6	\$ 5.59
FP-HS4332-BL	5" / 12.7 cm Round Ergonomic Hand Scrub - Blue only - 1 3/4" x 44 mm / 5" / 12.7 cm Brosse à main ronde ergonomique - bleu seulement - 1 3/4" x 44 mm				6/1	\$ 18.80

COUNTER BRUSHES / BROSSES DE COMPTOIR

PLASTIC BLOCK - GREEN FIBER / BLOC EN PLASTIQUE, FIBRES VERTES

- Ideal for fine dust particles where moisture may be encountered
- Idéale pour les particules de poussières fines, où l'humidité est présente.

WOOD BLOCK - TAMPICO FIBER / BLOC EN BOIS, FIBRES TAMPICO

- High quality counter/bannister brush ideal for cleaning all surfaces
- Brosse de comptoir et de rampe de haute qualité, idéale pour nettoyer toutes les surfaces

WOOD BLOCK HORSEHAIR FIBER / BLOC EN BOIS, CRIN DE CHEVAL

- Ideal for fine dust particles - soft sweeping
- Idéale pour les particules de poussières fines

WOOD BLOCK - SILVER TIP FIBER /

BLOC EN BOIS, EXTRÉMITÉS EFFILÉES COULEUR ARGENT

- High quality counter/bannister brush ideal for cleaning all surfaces
- Brosse de comptoir et de rampe de haute qualité, idéale pour nettoyer toutes les surfaces



M2 Code Code M2	Description	Pack Wt LB (S) Poids (lb) (S)	Pack Wt KG Poids (kg)	Cubic Ft Pi3	Pack Contenu	List Price Liste des prix
BBC-206GP	Counter Brush - Plastic Block Green Fiber / Brosse de comptoir, bloc en plastique, fibres vertes	8	3.5	.9	12	\$ 8.87
BBC-206T	Counter Brush - Wood Block Tampico Mix Fiber / Brosse de comptoir, bloc en bois, mélange de fibres tampico	8	3.5	.6	12	\$ 7.62
BBC-206M	Counter Brush - Wood Block Horsehair Mix Fiber / Brosse de comptoir, bloc en bois, mélange de crin de cheval	8	3.5	.6	12	\$ 11.03
BBC-206SF	Counter Brush - Wood Block Silver Tip Fiber / Brosse de comptoir, extrémités effilées griss, bloc en bois	8	3.5	.6	12	\$ 7.04

POT/RIG/UTILITY / BROSSES À CASSEROLES / UTILITAIRES

SHORT & LONG HANDLE POLY-PRO

- Poly-pro bristles ideal for scrubbing in the foodservice industry

BROSSES AVEC MANCHE LONG OU COURT GARNIES DE FIBRES DE POLYPROPYLÈNE

- Brosse à récurer garnie de fibres de polypropylène, idéale dans l'industrie de la restauration

SHORT & LONG HANDLE – BASSINE POT BRUSHES

- These wood handle brushes are filled with heat resistant Bassine fibers.
- Ideal for scrubbing tough surfaces

BROSSES À CASSEROLE À POIGNÉE COURTE OU LONGUE, EN FIBRES NATURELLES BASSINE

- Ces brosse à poignée en bois sont garnies de fibres Bassine thermorésistantes.
- Idéales pour frotter les surfaces dures



BRP-210WS-GF	9" / 22 cm Short Handle Detail Brush - Green Soft Flagged Fiber /	5	2	.5	12	\$ 12.91
BRP-210WL-GF	20" / 50 cm Long Handle Detail Brush - Green Soft Flagged Fiber /	9	4	1.2	6	\$ 17.40
BRP-210WS	9" / 22 cm Short Handle Pot Brush - White Fiber / Brosse à casserole à poignée courte, fibres blanches	5	2	.5	12	\$ 11.73
BRP-210WL	20" / 50 cm Short Handle Pot Brush - White Fiber / Brosse à casserole à poignée longue, fibres blanches	9	4	1.2	6	\$ 16.19
BRP-210BFS	9" / 22 cm Short Handle Pot Brush - Wood Block Bassine Fiber / Brosse à casserole à poignée courte, bloc en bois, fibres naturelles bassine	5	2	.5	12	\$ 8.62
BRP-210BFL	20" / 50 cm Long Handle Pot Brush - Wood Block Bassine Fiber / Brosse à casserole à poignée longue, bloc en bois, fibres naturelles bassine	9	4	1.2	12	\$ 16.19
BRP-210WHT	20" / 50 cm Long Handle Pot Brush - Wood Block Tampico Fiber / Brosse à casserole à poignée longue, bloc en bois, fibres naturelles tampico	9	4	1.2	12	\$ 17.39
BRP-210UNL	20" / 50 cm Long Handle Pot Brush 20" (50 cm) - Wood Block Union Fibre / Brosse à manche long 20" (50 cm), bloc de bois, fibres union	9	4	1.2	12	\$ 14.50



KALSOMINE/WHITEWASH BRUSHES / BROSSES À CHAUX - KALSOMINE

ALSO AVAILBLE IN /
AUSSI DISPONIBLE EN

SOFT /
DOUX

ACID
RESISTANT
RÉSISTANT
D'ACIDE



7" x 3/4"
18 cm x 2 cm
Block/Bloc



7" x 1 1/4"
18 cm x 3 cm
Block/Bloc



7" x 1 3/4"
18 cm x 4.5 cm
Block/Bloc



M2 Code Code M2	Description	Pack Wt LB (S) Poids (lb) (S)	Pack Wt KG Poids (kg)	Cubic Ft Pi3	Pack Contenu	List Price Liste des prix
BK-KW2027	7" Kalsomine/Whitewash Brush - 2 Row, Plastic Block / Kalsomine - Brosse à chaux 7" - 2 rangs, bloc de plastique	17	7.5	1.4	40/6	\$ 6.75
BK-KW2028	7" Kalsomine/Whitewash Brush - 4 Row, Plastic Block / Kalsomine - Brosse à chaux 7" - 4 rangs, bloc de plastique	7.5	3.4	1.4	20/6	\$ 8.62
BK-KW2029	7" Kalsomine/Whitewash Brush - 5 Row, Plastic Block / Kalsomine - Brosse à chaux 7" - 5 rangs, bloc de plastique	7.5	3.4	1.4	20/6	\$ 11.09
BK-KW2027-GN	7" Kalsomine/Whitewash Brush With 2 row Plastic Block - Green Fiber Kalsomine - Brosse à chaux 7" - 2 rangs, bloc de plastique - Fibre Vert	7.5	3.4	1.4	12	\$ 6.75
BK-KW2027-GY	7" Kalsomine/Whitewash Brush With 2 row Plastic Block - Grey Fiber Kalsomine - Brosse à chaux 7" - 2 rangs, bloc de plastique - Fibre Gris	7.5	3.4	1.4	12	\$ 6.75

MASONRY / KALSOMINE / BROSE DE MAÇONNERIE / À CHAUX



- 7" x 1 3/8" / 17cm x 3.5 cm
Wood block high quality
natural fiber
- 4 Rows of 2 3/8" / 4.5 cm
bristles
- Bloc en bois de 7 x 1 3/8 po/
17cm x 3.5 cm, fibres
naturelles de haute qualité
- 4 rangées de fibres de 2 3/8 po
/ 4.5 cm



- 6 1/2" x 2" / 17 x 5 cm Wood block
with longer high quality
natural fiber
- 5 Rows of 4" bristles
- Bloc en bois de
6 1/2 x 2 po / 17 x 5 cm
avec longues fibres
naturelles de haute qualité
- 5 rangées de fibres de 4 po

M2 Code Code M2	Description	Pack Wt LB (S) Poids (lb) (S)	Pack Wt KG Poids (kg)	Cubic Ft Pi3	Pack Contenu	List Price Liste des prix
BK-207L	7" Kalsomine/Whitewash Brush With Wood Block / Brosse de maçonnerie / à chaux, 7 po, avec bloc en bois	17	7.5	1.4	30/12	\$ 8.62
BK-397L	6 1/2" / 16 cm Large Kalsomine/Whitewash Brush With Wood Block / Grande brosse de maçonnerie / à chaux, 6 1/2 po / 16 cm, avec bloc en bois	7.5	3.4	.9	12	\$ 11.09

WIRE BRUSH / BROSSES À FILS D'ACIER

PLASTIC SHORT HANDLE /
POIGNÉE COURTE EN PLASTIQUE

MANCHE LONG ET COURT

- Ces brosses à fils d'acier
sont très pratiques pour
enlever la rouille, nettoyer
les grils de barbecue ou
décaper avant de peindre



LONG & SHORT HANDLE

- These handy wire
brushes are ideal for
removing rust and
debris from barbecue
grills or for scraping
prior to painting



M2 Code Code M2	Description	Pack Wt LB (S) Poids (lb) (S)	Pack Wt KG Poids (kg)	Cubic Ft Pi3	Pack Contenu	List Price Liste des prix
BW-1037	Wire Scratch Brushes 3 Row 13" / 33cm / Brosse fils d'acier, 3 rangées 13" / 33 cm	7	3.1		12	\$ 5.90
BW-1038	Shoe Handle Wire Scratch - 4 Rows 10" / 25cm / Brosse fils d'acier, manche long - 4 rangées 10 po / 25 cm	7	3.1		12	\$ 7.58
BW-1039	Plastic Handle Wire Scratch - 4 x 17 Rows 12" / 30cm - Black / Brosse à fils à manche de plastique - 4 x 17 rangs 12" / 30 cm noir				12	\$ 6.43

SPECIALTY BRUSHES / BROSSES SPÉCIALISÉES



M2 Code Code M2	Description	Pack Wt LB (S) Poids (lb) (S)	Pack Wt KG Poids (kg)	Cubic Ft Pi3	Pack Contenu	List Price Liste des prix
RT-DB-9185	Dish Brush / Brosse à vaisselle				48	\$ 3.41
RT-CB-9318	Cookware Brush / Brosse à chaudrons				48	\$ 3.84
RT-DM-9217	Dish Mop / Lavette à vaisselle				48	\$ 3.60



RT-FB-9235	Flexible Scrub Brush / Brosse à récurer flexible				48	\$ 4.35
RT-BB-9234	Bottle Brush / Brosse à bouteille				48	\$ 3.27
RT-SD-9174	Soap Dispensing Brush / Brosse distributrice de savon				48	\$ 5.85



RT-SB9175	Hand Grip Scrub Brush / Brosse à récurer manuelle				48	\$ 5.57
RT-GB-9196	Tile Grout Brush / Brosse à coulis de carrelage				48	\$ 2.95
BR-UT60306	Hand Held Grout Cleaner / Brosse à main pour coulis	.52	.24	.30	10/5	\$ 5.06

NAIL & HAND BRUSHES / BROSSES À ONGLES ET À MAINS

6" SCRUB / BROSSE, 6 PO

- Medium poly-pro fill for scrubbing in most areas
- Garnie de fibres en polypropylène moyennes pour nettoyer la plupart des endroits

HAND & NAIL / MAINS ET ONGLES

- Soft to medium poly-pro fill for cleaning
- Garnie de fibres en polypropylène de douces à moyennes



BR-SC229	6" Scrub with Handle / 6" Brosse avec poignée	2.3	1	.2	6	\$ 4.52
RT-IB-9307	Iron Brush / Brosse en fer				48	\$ 5.15
BR-SC231	4.5" x 1.5" Hand and Nail Brush / 4.5" x 1.5" Brosse à main et ongles	1.8	.8	.2	12	\$ 3.24
RT-NB-9319	Nail Brush / Brosse à ongles				48	\$ 3.04



PROFESSIONAL PUTTY KNIVES/ COUTEAU À MASTIC PROFESSIONNEL



WS-PT200



WS-PT201



WS-PT202



WS-SC205



WS-SC206



WS-SCR004 /
WS-SCR005



FP-PA8502

WS-PT200	1-1/2 / 3.8 cm Professional Flexible Putty Knife / 1-1/2 / 3.8 cm Couteau à mastic professionnel flexible	10	\$ 16.92
WS-PT201	1-1/2 / 3.8 cm Professional Stiff Putty Knife / 1-1/2 / 3.8 cm Couteau à mastic professionnel rigide	5	\$ 16.92
WS-PT202	1-3/16 / 3 cm Professional Flexible Putty Knife / 1-3/16 / 3 cm Couteau à mastic professionnel flexible	5	\$ 11.73
WS-SC205	Economy Safety Scraper 1 1/2" / 3.8 cm / Grattoir de sécurité économique - 1 1/2" / 3.8 cm	10	\$ 7.31
WS-SC206	Plastic Safety Scraper / Grattoir de sécurité en plastique	10	\$ 5.41
WS-SCR004	0.009" Replacement Razor Scraper Blades for (Pack 5) / 0.009" Lame de remplacement de grattoir (Paq 5)	5	\$ 4.13
WS-SCR005	0.009" Replacement Razor Scraper Blades for (Pack 100) / 0.009" Lame de remplacement de grattoir (Paq 100)	5	\$ 40.67
FP-PA8502	9.75" / 25 cm Part Brush Black bristles/ Brosse de pièces fibres noires - 9.75" / 25 cm	12/1	\$ 11.92



TIGER SIDE CLIPPED RETAIL PUSHBROOMS - COMPLETE WITH HANDLES

BALAIS-POUSSOIR CLIPPÉS SUR LE CÔTÉ – COMPLETS AVEC MANCHES

M2's All Purpose Pushbrooms can sweep debris ranging from fine dust particles on smooth surfaces, to coarse gravel and dust on rough surfaces. They are designed for indoor and/or outdoor use under wet or dry conditions.

Our High Quality All Purpose Pushbrooms come clipped to the handles and pre-packaged, making them perfect for retail displays.

Les balais-poussoir tous-usages de M2, peuvent balayer des débris allant des fines particules de poussière sur les surfaces lisses, au gravier grossier et à la poussière sur les surfaces rugueuses. Ils sont conçus pour une utilisation intérieurs et/ou extérieure dans des conditions humides ou sèches.

Nos balais-poussoir polyvalents de haute qualité sont clipsés aux manches, pré-emballés, ce qui en fait un produit parfait pour les présentoirs de vente au détail.

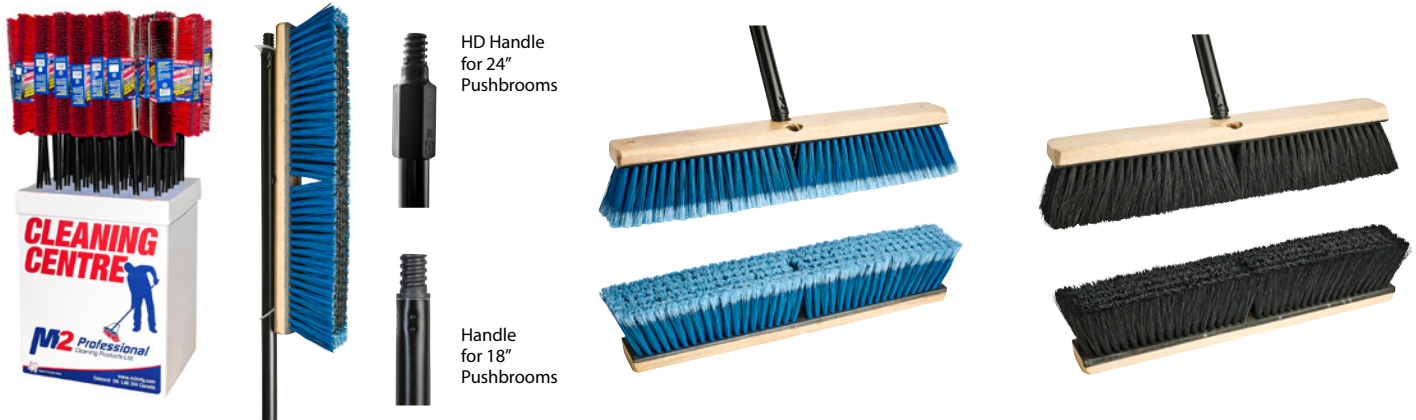

M2 Code Code M2	Description	Pack Wt LB (S) Poids (lb) (S)	Pack Wt KG Poids (kg)	Cubic Ft Pi3	Pack Contenu	List Price Liste des prix
SIDE CLIPPED FINE FLAGGED TIP BROOM with BLACK METAL HANDLE /						
PB-600-BT18	18" / 45 cm - Side Clipped Fine flagged tip with 54"/137 cm - Black Handle	18.16	8.23	3.09	6	\$ 39.51
PB-600-BT24	24" / 60 cm - Side Clipped Fine flagged tip with - HD Black Handle – 54"/137 cm	21.28	9.65	3.09	6	\$ 46.34
SIDE CLIPPED MEDIUM TAMPICO BROOM with BLACK METAL HANDLE & BRACE /						
PB-610-T18	18" / 45 cm - Side Clipped Medium Tampico with - Black Handle – 54"/137 cm /	18.16	8.23	3.09	6	\$ 41.72
PB-610-T24	24" / 60 cm - Side Clipped Medium Tampico with - HD Black Handle – 54"/137 cm /	21.28	9.65	3.09	6	\$ 49.25



SIDE CLIPPED MEDIUM BLACK/RED with BLACK METAL HANDLE /						
PB-540-RB14	14"/35 cm Tiger- Black/Red Fiber - Medium with 48"/122 cm - Black Handle	16.17	7.33	3.09	9	\$ 21.78
PB-540-RB18	18"/45 cm TBlack/Red Fiber - Medium with 54"/137 cm - Black Handle	18.16	8.23	3.09	6	\$ 25.72
PB-540-RB24	24"/60 cm Black/Red Fiber - Medium with 54"/137 cm - Black Handle	21.28	9.65	3.09	6	\$ 29.82
SIDE CLIPPED COURSE GARAGE BROOM with BLACK METAL HANDLE /						
PB-620-G18	18" / 45 cm - Side Clipped Coarse Garage with - Black Handle – 54"/137 cm	18.16	8.23	3.09	6	\$ 38.07
PB-620-G24	24" / 60 cm - Side Clipped Coarse Garage with HD Black Handle – 54"/137 cm	21.28	9.65	3.09	6	\$ 44.37
SIDE CLIPPED COURSE BLUE/BLACK with BLACK METAL HANDLE /						
PB-630-BB18	18" / 45 cm - Side Clipped Medium Blue/Black with - Black Handle – 54"/137 cm	19.31	8.76	3.09	6	\$ 31.07
PB-630-BB24	24" / 60 cm - Side Clipped Medium Blue/Black with HD Black Handle – 54"/137 cm	22.42	10.17	3.09	6	\$ 35.21



RYNO

RYNO PUSHBROOM COMES COMPLETE WITH BRACE & HEAVY DUTY HANDLE FULLY ASSEMBLED BALAI-POUSSOIR RYNO AVEC ENTRETOISE ET MANCHE EXTRA ROBUSTE ENTIÈREMENT ASSEMBLÉ



SOFT/ DOUX

M2 Code Code M2	Description	Pack Wt LB (S) Poids (lb) (S)	Pack Wt KG Poids (kg)	Cubic Ft Pi3	Pack Contenu	List Price Liste des prix
PB-810-BT18	18"/45 cm Ryno - Soft PVC Fiber, brace & tapered handle assembled - Blue Ryno, fibre douce, 18/45 cm po, entretoise et manche à bout fuselé, assemblés, bleu	19	9	4.7	4	\$ 47.47
PB-810-BT24	24"/60 cm Ryno - Soft PVC Fiber, brace & tapered handle assembled - Blue Ryno, fibre douce, 24/60 cm po, entretoise et manche à bout fuselé assemblés, bleu	23	11	1.3	4	\$ 54.61
PB-810-BT24	24"/60 cm Ryno - Soft PVC Fiber, brace & tapered handle assembled - Blue Ryno, fibre douce, 24/60 cm po, entretoise et manche à bout fuselé assemblés, bleu	23	11	1.3	4	\$ 82.61

MEDIUM / MOYEN

PB-800-BB18	18"/45 cm Ryno - Soft Fiber, brace & tapered handle assembled - Blue Ryno, fibre douce, 18/45 cm po, entretoise et manche à bout fuselé, assemblés, bleu	19	9	4.7	4	\$ 46.61
PB-800-BB24	24"/60 cm Ryno - Soft Fiber, brace & tapered handle assembled - Blue Ryno, fibre douce, 24/60 cm po, entretoise et manche à bout fuselé assemblés, bleu	23	11	1.3	4	\$ 55.32
PB-800-RB18	18"/45 cm Ryno - Medium PCV fill with brace & tapered handle assembled - Red / Black / 18"/45 cm Ryno - Remplissage moyen en PCV avec renfort et poignée conique assemblés, rouge / noir	19	9	4.7	4	\$ 46.61
PB-800-RB24	24"/60 cm Ryno - Medium PCV fill with brace & tapered handle assembled - Red / Black / 24"/60 cm Ryno - Remplissage moyen en PCV avec renfort et poignée conique assemblés, rouge / noir	23	11	1.3	4	\$ 55.32
PB-800-RB36	36"/90 cm Ryno - Medium PCV fill with brace & tapered handle assembled - Red / Black / 36"/90 cm Ryno - Remplissage moyen en PCV avec renfort et poignée conique assemblés, rouge / noir				4	\$ 82.61
PB-800-RB48	48"/122 cm Ryno - Medium PCV fill with brace & tapered handle assembled - Red / Black / 48"/122 cm Ryno - Remplissage moyen en PCV avec renfort et poignée conique assemblés, rouge / noir				1	\$ 147.35



STIFF / RIGIDE

PB-700-GB18	18"/45 cm Ryno Stiff - PVC fill, brace & tapered handle - Green /- Assembled Ryno - Rigide,, fibres en PVC, 18/45 cm po, entretoise et manche à bout fuselé, vert	19	9	7.3	4	\$ 46.62
PB-700-GB24	24"/60 cm Ryno Stiff - PVC fill, brace & tapered handle - Green /- Assembled Ryno - Rigide, fibres en PVC, 24/60 cm po, entretoise et manche à bout fuselé, vert - Assemblé	23	11	2.9	4	\$ 55.31
PB-700-RB18	18"/45 cm Ryno Stiff - PVC fill, brace & tapered handle - Red/Black/- Assembled Ryno - Rigide, fibres en PVC, 18/45 cm po, entretoise et manche à bout fuselé, rouge - Assemblé	19	9	4.7	4	\$ 46.61
PB-700-RB24	24"/60 cm Ryno Stiff - PVC fill, brace & tapered handle - Red/Black/- Assembled Ryno - Rigide, fibres en PVC, 24/60 cm po, entretoise et manche à bout fuselé, rouge - Assemblé	23	11	1.3	4	\$ 55.32
PB-700-RB36	36"/90 cm Ryno Stiff - PVC fill, brace & tapered handle - Red/Black/- Assembled Ryno - Rigide, fibres en PVC, 36/90 cm po, entretoise et manche à bout fuselé, rouge/noir - Assemblé	23	11	1.3	4	\$ 82.61
PB-700-BB18	18"/45 cm Ryno Stiff - PVC fill, brace & tapered handle - Blue/Black/- Assembled Ryno - Rigide, fibres en PVC, 18/45 cm po, entretoise et manche à bout fuselé, bleu/noir - Assemblé	19	9	4.7	4	\$ 46.61
PB-700-BB24	24"/60 cm Ryno Stiff - PVC fill, brace & tapered handle - Blue/Black/- Assembled Ryno - Rigide, fibres en PVC, 24/60 cm po, entretoise et manche à bout fuselé, bleu/noir - Assemblé	23	11	1.3	4	\$ 55.32
PB-700-BB36	36"/90 cm Ryno Stiff - PVC fill, brace & tapered handle - Blue/Black/- Assembled Ryno - Rigide, fibres en PVC, 36/90 cm po, entretoise et manche à bout fuselé, bleu/noir - Assemblé	23	11	1.3	4	\$ 82.81

EXTRA STIFF / EXTRA RIGIDE

PB-720-OR18	18"/45 cm Ryno Extra Stiff - PVC fill, brace & tapered handle - Orange/Black/- Assembled Ryno, Extra Rigide, fibres en PVC, 18/45 cm po, entretoise et manche à bout fuselé, orange/noir - Assemblé	19	9	4.7	4	\$ 46.61
PB-720-OR24	24"/60 cm Extra Stiff Ryno - PVC fill, brace & tapered handle - Orange/Black/- Assembled Ryno, Extra Rigide fibres en PVC, 24/60 cm po, entretoise et manche à bout fuselé, orange/noir - Assemblé	23	11	1.3	4	\$ 55.32
PB-720-OR36	36"/90 cm Extra Stiff Ryno - PVC fill, brace & tapered handle - Orange/Black/- Assembled Ryno, Extra Rigide fibres en PVC, 36/90 cm po, entretoise et manche à bout fuselé, orange/noir - Assemblé	23	11	1.3	4	\$ 82.61
PB-720-OR48	48"/121 cm Extra Stiff Ryno - PVC fill, brace & tapered handle - Orange/Black/- Assembled Ryno, Extra Rigide fibres en PVC, 48/121 cm po, entretoise et manche à bout fuselé, orange/noir - Assemblé	23	11	1.3	4	\$ 147.35

RYNO UN-ASSEMBLED IN ONE BOX / BALAI RYNO NON-ASSEMBLÉ DANS UNE BOÎTE



M2 Code Code M2	Description	Pack Wt LB (S) Poids (lb) (S)	Pack Wt KG Poids (kg)	Cubic Ft Pi3	Pack Contenu	List Price Liste des prix
PB-700-GB18-UNA	18"/45 cm Ryno – PVC Stiff fibre fill, Brace & Tapered Handle - Green/Black - Shipped Un-assembled in One Box Ryno, fibres en PVC rigide, 18/45 cm po, entretoise et manche à bout fuselé, vert/noir - Expédié non assemblé dans une boîte	19	9	4.7	6	\$ 42.16
PB-700-GB24-UNA	24"/60 cm Ryno – PVC Stiff fibre fill, Brace & Tapered Handle - Green/Black - Shipped Un-assembled in One Box Ryno, fibres en PVC rigide, 24/60 cm po, entretoise et manche à bout fuselé, vert/noir - Expédié non assemblé dans une boîte	23	11	1.3	4	\$ 50.14

BULLDOG BROOM COMPLETE / BALAI BULLDOG COMPLET



M2 Code Code M2	Description	Pack Wt LB (S) Poids (lb) (S)	Pack Wt KG Poids (kg)	Cubic Ft Pi3	Pack Contenu	List Price Liste des prix
PB-BD700-GB18	18"/45 cm Bulldog Stiff Non Flagged Green Outside/Black fill with Bulldog Bracket, Brace, & Tapered Handle - Assembled / 18"/45 cm				4	\$ 47.04
PB-BD700-GB24	24"/60 cm Bulldog Stiff Non Flagged Green Outside/Black fill with Bulldog Bracket, Brace, & Tapered Handle - Assembled / 24"/60 cm				4	\$ 54.76
PB-BD700-GB36	36"/90 cm Bulldog Stiff Non Flagged Green Outside/Black fill with Bulldog Bracket, Brace, & Tapered Handle - Assembled / 36"/90 cm				4	\$ 87.82



M2 Code Code M2	Description	Pack Wt LB (S) Poids (lb) (S)	Pack Wt KG Poids (kg)	Cubic Ft Pi3	Pack Contenu	List Price Liste des prix
PB-BD900-GB18	18"/45 cm Bulldog Medium - Soft Green Outside/Black fill with Bulldog Bracket, Brace, & Tapered Handle - Assembled / 18"/45 cm				4	\$ 47.04
PB-BD900-GB24	24"/60 cm Bulldog Medium - Soft Green Outside/Black fill with Bulldog Bracket, Brace, & Tapered Handle - Assembled / 24"/60 cm				4	\$ 54.76
PB-BD900-GB36	36"/90 cm Bulldog Medium - Soft Green Outside/Black fill with Bulldog Bracket, Brace, & Tapered Handle - Assembled / 36"/90 cm				4	\$ 87.82



M2 Code Code M2	Description	Pack Wt LB (S) Poids (lb) (S)	Pack Wt KG Poids (kg)	Cubic Ft Pi3	Pack Contenu	List Price Liste des prix
PB-BD800-RB18	18"/45 cm Bulldog Medium Red/Black Flagged fill with Bulldog Bracket, Brace, & Tapered Handle - Assembled / 18"/45 cm				4	\$ 47.04
PB-BD800-RB24	24"/60 cm Bulldog Medium Red/Black Flagged fill with Bulldog Bracket, Brace, & Tapered Handle - Assembled / 24"/60 cm				4	\$ 54.76
PB-BD800-RB36	36"/90 cm Bulldog Medium Red/Black Flagged fill with Bulldog Bracket, Brace, & Tapered Handle - Assembled / 36"/90 cm				4	\$ 87.82



BULLDOG HEAD ONLY / TÊTE SEULEMENT



SOFT/ DOUX

M2 Code Code M2	Description	Pack Wt LB (S) Poids (lb) (S)	Pack Wt KG Poids (kg)	Cubic Ft Pi3	Pack Contenu	List Price Liste des prix
PB-BD801-BT18	18"/45 cm Bulldog – PVC Soft fibre fill, Head Only - Blue Bulldog, fibres en PVC doux, 18/45 cm po, Tête seulement, bleu	19	9	4.7	12	\$ 26.39
PB-BD801-BT24	24"/60 cm Bulldog – PVC Soft fibre fill, Head Only - Blue Bulldog, fibres en PVC doux, 24/60 cm po, Tête seulement, bleu	23	11	1.3	12	\$ 36.72
PB-BD801-BT36	36"/90 cm Bulldog – PVC Soft fibre fill, Head Only - Blue Bulldog, fibres en PVC doux, 36/90 cm po, Tête seulement, bleu				6	\$ 56.40



MEDIUM STIFF / MOYEN RIGIDE

PB-BD701-RB18	18"/45 cm Bulldog – PVC Medium/Stiff fibre fill, Head Only - Red Bulldog, fibres en PVC moyen/rigide, 18/45 cm po, Tête seulement, rouge	19	9	4.7	12	\$ 26.39
PB-BD701-RB24	24"/60 cm Bulldog – PVC Medium/Stiff fibre fill, Head Only - Red Bulldog, fibres en PVC moyen/rigide, 24/60 cm po, Tête seulement, rouge	23	11	1.3	12	\$ 36.72
PB-BD701-RB36	36"/90 cm Bulldog – PVC Medium/Stiff fibre fill, Head Only - Red Bulldog, fibres en PVC moyen/rigide, 36/90 cm po, Tête seulement, rouge				6	\$ 56.40



STIFF / RIGIDE

PB-BD701-GB18	18"/45 cm Bulldog – PVC Medium/Stiff Fibre Fill, Head Only - Green/Black Bulldog, fibres en PVC moyen/rigide, 18/45 cm po, Tête seulement, vert/noir	19	9	4.7	12	\$ 26.39
PB-BD701-GB24	24"/60 cm Bulldog – PVC Medium/Stiff Fibre Fill, Head Only - Green/Black Bulldog, fibres en PVC moyen/rigide, 24/60 cm po, Tête seulement, vert/noir	23	11	1.3	12	\$ 36.72
PB-BD701-GB36	36"/90 cm Bulldog – PVC Medium/Stiff Fibre Fill, Head Only - Green/Black Bulldog, fibres en PVC moyen/rigide, 36/90 cm po, Tête seulement, vert/noir				6	\$ 56.40

RYNO HEAD ONLY / TÊTE SEULEMENT



SOFT/ DOUX

M2 Code Code M2	Description	Pack Wt LB (S) Poids (lb) (S)	Pack Wt KG Poids (kg)	Cubic Ft Pi3	Pack Contenu	List Price Liste des prix
PB-811--BT18-HO	18"/45 cm Ryno – PVC Soft fibre fill, Head Only - Blue Ryno, fibres en PVC doux, 18/45 cm po, Tête seulement, bleui	19	9	4.7	12	\$ 26.39
PB-811--BT24-HO	24"/60 cm Ryno – PVC Soft fibre fill, Head Only - Blue Ryno, fibres en PVC doux, 24/60 cm po, Tête seulement, bleu	23	11	1.3	12	\$ 36.72
PB-811--BT36-HO	36"/90 cm Ryno – PVC Soft fibre fill, Head Only - Blue Ryno, fibres en PVC doux, 36/90 cm po, Tête seulement, bleu				6	\$ 56.40



MEDIUM/MOYEN

PB-801-RB18-HO	18"/45 cm Ryno – PVC Medium fibre fill, Head Only - Red/Black Ryno, fibres en PVC doux, 18/45 cm po, Tête seulement, rouge/noir	19	9	4.7	12	\$ 26.39
PB-801-RB24-HO	24"/60 cm Ryno – PVC Medium fibre fill, Head Only - Red/Black Ryno, fibres en PVC doux, 24/60 cm po, Tête seulement, rouge/noir	23	11	1.3	12	\$ 36.72
PB-801-RB36-HO	36"/90 cm Ryno – PVC Medium fibre fill, Head Only - Red/Black Ryno, fibres en PVC doux, 36/90 cm po, Tête seulement, rouge/noir				6	\$ 56.40
PB-801-RB48-HO	48"/122 cm Ryno – PVC Medium fibre fill, Head Only - Red/Black Ryno, fibres en PVC doux, 36/122 cm po, Tête seulement, rouge/noir				6	\$ 105.09



STIFF/MOYEN

PB-701-GB18-HO	18"/45 cm Ryno – PVC Stiff fibre fill, Head Only - Green/Black Ryno, fibres en PVC rigide, 18/45 cm po, Tête seulement, vert/noir	19	9	4.7	12	\$ 26.39
PB-701-GB24-HO	24"/60 cm Ryno– PVC Stiff fibre fill, Head Only - Green/Black Bulldog, fibres en PVC rigide, 24/60 cm po, Tête seulement, vert/noir	23	11	1.3	12	\$ 36.72
PB-701-BB18-HO	18"/45 cm Ryno – PVC Stiff fibre fill, Head Only - Blue/Black Ryno, fibres en PVC rigide, 18/45 cm po, Tête seulement, bleu/noir	19	9	4.7	12	\$ 26.39
PB-701-BB24-HO	24"/60 cm Ryno – PVC Stiff fibre fill, Head Only - Blue/Black Ryno, fibres en PVC rigide, 24/60 cm po, Tête seulement, bleu/noir	23	11	1.3	12	\$ 36.72
PB-701-RB18-HO	18"/45 cm Ryno – PVC Stiff fibre fill, Head Only - Red/Black Bulldog, fibres en PVC rigide, 18/45 cm po, Tête seulement, rouge/noir	19	9	4.7	12	\$ 26.39
PB-701-RT24-HO	24"/60 cm Ryno – PVC Stiff fibre fill, Head Only - Red/Black Ryno, fibres en PVC rigide, 24/60 cm po, Tête seulement, rouge/noir	23	11	1.3	12	\$ 36.72



**EXTRA STIFF
SUPPLÉMENTAIRE
RIGIDE**

EXTRA STIFF / SUPPLÉMENTAIRE RIGIDE

PB-701-OR18-HO	18"/45 cm Ryno – PVC Ext Stiff fill, Head Only - Orange/Black Ryno, fibres en PVC supplémentaire rigide, 18/45 cm po, Tête seulement, orange/noir	19	9	4.7	12	\$ 26.39
PB-701-OR24-HO	24"/60 cm Ryno – PVC Ext Stiff fibre fill, Head Only - Orange/Black Ryno, fibres en PVC supplémentaire rigide, 24/60 cm po, Tête seulement, orange/noir	23	11	1.3	12	\$ 36.72



SQUEEGEE BROOM WITH HANDLE / BALAI RACLOIR AVEC MANCHE



M2 Code Code M2	Description	Pack Wt LB (S) Poids (lb) (S)	Pack Wt KG Poids (kg)	Cubic Ft Pi3	Pack Contenu	List Price Liste des prix
PB-SQB9824	24" Squeegee Broom with Metal Handle / Balai à raclette de 24 po avec poignée en métal				6	\$ 38.35
FH-M360-BK	1" /2.5 cm x 60" / 152 cm Black Metal handle with Hex and hanger cap – Threaded Tip Manche bleu avec capuchon de suspension, droit et à bout non fileté en métal - 1 po/ 2.5 cm x 60 po/ 152 cm	9	4.5	.6	12/6	\$ 6.70

RYNO & BULLDOG HANDLES & BRACES / MANCHE ET ENTRETOISE RYNO ET BULLDOG

Newly designed bolt-on brace / Nouvelle entretoise à boulonner

Straight Cut Chuck
Coupe droite

Ryno Bracket /
Renfort Ryno



M2 Code Code M2	Description	Pack Wt LB (S) Poids (lb) (S)	Pack Wt KG Poids (kg)	Cubic Ft Pi3	Pack Contenu	List Price Liste des prix
FH-W360-118NT-CH	Straight Cut Chucked 1-3/4 to 1"D 1-1/8" X 60" / Coupe droite, 1-3/4 à 1 po P 1-1/8 po X 60 po			1	25/1	\$ 10.34
PB-351	Broom brace - Black / Entretoise pour balai, noir	4	2	.2	12/1	\$ 6.11
PB-700-BKT	Ryno Bracket Only / Support pour Ryno	.2	.1	.1	1	\$ 12.35
PB-700-BKT-60	Bulldog Connector and 60" - 1 1/8" Tapered Wood Handle /				1	\$ 29.95

SNOW/SAND BOOT BRUSH / BROSE À BOTTES - NEIGE/SABLE



- Stainless Steel Bracket
- Support en acier inoxydable

M2 Code Code M2	Description	Pack Wt LB (S) Poids (lb) (S)	Pack Wt KG Poids (kg)	Cubic Ft Pi3	Pack Contenu	List Price Liste des prix
BB-410	Bi-Level Boot Brush / Brosse à bottes deux niveaux	2.95	1.34	.277	1	\$ 116.66

FINE SWEEP / POUR POUSSIÈRES FINES

For smooth indoor surfaces / Pour des surfaces intérieures lisses

HORSEHAIR

- Blend of synthetic fibers that effectively captures fine dust particles on smooth indoor surfaces

HORSEHAIR

- Mélange de crin de cheval et de fibres synthétiques qui piège les particules de poussières fines sur les surfaces intérieures lisses



M2 Code Code M2	Description	Pack Wt LB (S) Poids (lb) (S)	Pack Wt KG Poids (kg)	Cubic Ft Pi3	Pack Contenu	List Price Liste des prix
PB-M14	14" / 35 cm Imitation Horsehair & Synthetic Mix - Wood / Balai-poussoir en crin de cheval et fibres synthétiques, 14 po / 35 cm, en bois	14	7	1	12	\$ 17.59
PB-M18	18" / 45 cm Imitation Horsehair & Synthetic Mix - Wood / Balai-poussoir en crin de cheval et fibres synthétiques, 18 po / 45 cm, en bois	20	9	1.3	12	\$ 22.99
PB-M24	24" / 60 cm Imitation Horsehair & Synthetic Mix - Wood / Balai-poussoir en crin de cheval et fibres synthétiques, 24 po / 60 cm, en bois	25	11	1.7	12	\$ 30.88
PB-M36	36" / 90 cm Imitation Horsehair & Synthetic Mix - Wood / Balai-poussoir en crin de cheval et fibres synthétiques, 36 po 90 cm, en bois	42	19	2.7	6/1	\$ 54.37

POLYSTYRENE

- Flagged bristles are ideal for us in areas that are affected by detergents and most acid
- Ideal for fine sweeping fine particles of dirt on smooth surfaces indoors

POINTES MARQUÉES BLEU

- Les poils à pointes marquées sont idéals aux endroits endommagés par les détergents et la plupart des produits acides.
- Idéales pour balayer des fines particules de salissures sur des surfaces intérieures lisses



M2 Code Code M2	Description	Pack Wt LB (S) Poids (lb) (S)	Pack Wt KG Poids (kg)	Cubic Ft Pi3	Pack Contenu	List Price Liste des prix
PB-BT14	14" / 35 cm Blue Flagged Tip Fiber - Wood / Pointes marquées, 14" / 35 cm, bleus, en bois	15	7	1	12	\$ 15.15
PB-BT18	18" / 45 cm Blue Flagged Tip Fiber - Wood / Pointes marquées, 18" / 45 cm, bleus, en bois	20	9	1.3	12	\$ 20.35
PB-BT24	24" / 60 cm Blue Flagged Tip Fiber - Wood / Pointes marquées, 24" / 60 cm, bleus, en bois	25	11	1.7	12	\$ 25.89
PB-BT36	36" / 90 cm Blue Flagged Tip Fiber - Wood / Pointes marquées, 36" / 90 cm, bleus, en bois	42	19	2.7	6/1	\$ 47.63

TAMPICO

- Soft to medium texture with good durability
- An Overall "all purpose" broom that is ideal in any warehouse or indoor facility where fine particles need to be swept or picked up

FIBRES DE TAMPICO

- Texture de souple à moyenne avec une bonne résistance
- Un balai tout usage idéal pour enlever les particules fines dans un entrepôt ou une installation intérieure



M2 Code Code M2	Description	Pack Wt LB (S) Poids (lb) (S)	Pack Wt KG Poids (kg)	Cubic Ft Pi3	Pack Contenu	List Price Liste des prix
PB-T14	14" / 35 cm Tampico Fiber - All purpose - Wood /Fibres de tampico, 14" / 35 cm, tout usage, en bois	15	7	1	12	\$ 12.98
PB-T18	18" / 45 cm Tampico Fiber - All purpose - Wood /Fibres de tampico, 18" / 45 cm, tout usage, en bois	20	9	1.3	12	\$ 16.79
PB-T24	24" / 60 cm Tampico Fiber - All purpose - Wood / Fibres de tampico, 24" / 60 cm, tout usage, en bois	25	11	1.7	12	\$ 21.03
PB-T36	36" / 90 cm Tampico Fiber - All purpose - Wood / Fibres de tampico, 36" / 90 cm, tout usage, en bois	42	19	2.7	6/1	\$ 37.37



MEDIUM SWEEP / POUR POUSSIÈRES MOYENNES

For unfinished surfaces / pour des surfaces brutes



POLYPROPYLENE /PET FILL

- Extremely resilient and has probably the best recovery rate of all the synthetic fibers
- Ideal where low abrasion is important
- Good resistant to a variety of chemicals

FIBRE POLYPROPYLENE/PET

- Extrêmement résistant et possède probablement le meilleur taux de récupération de toutes les fibres synthétique.
- Idéal pour nettoyer les endroits où le frottement doit être faible.
- Bonne résistance à divers produits chimiques

M2 Code Code M2	Description	Pack Wt LB (S) Poids (lb) (S)	Pack Wt KG Poids (kg)	Cubic Ft Pi3	Pack Contenu	List Price Liste des prix
PB-PE14	14" / 35 cm Polypropylene/PET Fiber – Wood / Fibre Polypropylene/PET, 14" / 35 cm, en bois	15	7	1	12	\$ 10.91
PB-PE18	18" / 45 cm Polypropylene/PET Fiber – Wood / Fibre Polypropylene/PET, 18" / 45 cm, en bois	20	9	1.3	12	\$ 14.40
PB-PE24	24" / 60 cm Polypropylene/PET Fiber – Wood / Fibre Polypropylene/PET, 24" / 60 cm, en bois	25	11	1.7	12	\$ 18.21
PB-PE36	36" / 90 cm Polypropylene/PET Fiber – Wood / Fibre Polypropylene / PET, 36" / 90 cm, en bois	42	19	2.7	6	\$ 34.11



COMBINATION SYNTHETIC FILL

- Ideal as an all-purpose choice for indoors on wood, linoleum or concrete floors
- Can be use outdoors on smooth surfaces
- Use with sweeping compound

MÉLANGE DE FIBRES SYNTHÉTIQUES

- Idéal comme balai tout usage sur des surfaces intérieures en bois, en linoléum ou en béton
- Peut être utilisé sur des surfaces extérieures lisses
- Utiliser avec un composé de balayage

M2 Code Code M2	Description	Pack Wt LB (S) Poids (lb) (S)	Pack Wt KG Poids (kg)	Cubic Ft Pi3	Pack Contenu	List Price Liste des prix
PB-RB14	14" / 35 cm Black/Red – Medium Coarse Synthetic Fill – Wood / Fibres synthétiques moyennes-grossières, 14" / 35 cm, noir/rouge, en bois	15	7	1	12	\$ 11.24
PB-RB18	18" / 45 cm Black/Red – Medium Coarse Synthetic Fill – Wood / Fibres synthétiques moyennes-grossières, 18" / 45 cm, noir/rouge, en bois	20	9	1.3	12	\$ 14.77
PB-RB24	24" / 60 cm Black/Red – Medium Coarse Synthetic Fill – Wood / Fibres synthétiques moyennes-grossières, 24" / 60 cm, noir/rouge, en bois	25	11	1.7	12	\$ 19.08
PB-RB36	36" / 90 cm Black/Red – Medium Coarse Synthetic Fill – Wood / Fibres synthétiques moyennes-grossières, 36" / 90 cm, noir/rouge, en bois	42	19	2.7	6	\$ 34.81



GARAGE CONCRETE

- Heavy duty durable polystyrene makes this broom ideal for sweeping heavy soils on medium to rough surfaces
- Ideal for working both outdoors and indoors

BALAI GARAGE ET BÉTON

- Ce balai robuste et résistant en polystyrène est idéal sur les surfaces dures ou rugueuses avec déchets importants
- Idéal sur des surfaces intérieures et extérieures

M2 Code Code M2	Description	Pack Wt LB (S) Poids (lb) (S)	Pack Wt KG Poids (kg)	Cubic Ft Pi3	Pack Contenu	List Price Liste des prix
PB-G14	14" / 35 cm Garage Concrete – Wood / Balai garage, 14" / 35 cm, en bois	15	7	1	12	\$ 11.17
PB-G18	18" / 45 cm Garage Concrete – Wood / Balai garage, 18" / 45 cm, en bois	20	9	1.3	12	\$ 14.27
PB-G24	24" / 60 cm Garage Concrete – Wood / Balai garage, 24" / 60 cm, en bois	25	11	1.7	12	\$ 17.93
PB-G36	36" / 90 cm Garage Concrete – Wood / Balai garage, 36" / 90 cm, en bois	42	19	2.7	6	\$ 33.61

COARSE SWEEP / POUR GROS DÉBRIS

For rough and unfinished surfaces / pour des surfaces rugueuses et brutes

H-BLACK MIX & BASSINE FILL CENTRE

- An all natural pushbroom combining a stiff palmyra centre core surrounded by and outer row of medium fibres.

FIBRES MÉLANGÉES H-BLACK ET CENTRE GARNI DE FIBRES BASSINE

- Un balai-brosse en fibres naturelles avec des fibres bassine raides au centre et des fibres moyennes à l'extérieur



M2 Code Code M2	Description	Pack Wt LB (S) Poids (lb) (S)	Pack Wt KG Poids (kg)	Cubic Ft Pi3	Pack Contenu	List Price Liste des prix
PB-HB18	18" / 45 cm Black Mix & Bassine Centre - Wood / Fibres mélangées et centre en fibres bassine, 18" / 45 cm, noir, en bois	21	10	1.3	12	\$ 15.33
PB-HB24	24" / 60 cm Black Mix & Bassine Centre - Wood / Fibres mélangées et centre en fibres bassine, 24" / 60 cm, noir, en bois	30	13	1.7	12	\$ 19.72
PB-HB36	36" / 90 cm Black Mix & Bassine Centre - Wood / Fibres mélangées et centre en fibres bassine, 24" / 60 cm, noir, en bois	48	22	2.6	6/1	\$ 41.32

BASSINE/ PALMYRA FILL

- Complete natural fiber that poses no harm to the environment
- It has good resistance to friction and heat, and will withstand many chemicals and solvents.
- Ideal for rough surfaces indoors and outdoors in both wet and dry areas

FAIT DE FIBRES BASSINES PALMYRA

- Complètement de fibres naturelles qui ne causent pas de dommage à l'environnement.
- Bonne résistance à la friction et la chaleur, et résistera à plusieurs produits chimiques et solvants.



M2 Code Code M2	Description	Pack Wt LB (S) Poids (lb) (S)	Pack Wt KG Poids (kg)	Cubic Ft Pi3	Pack Contenu	List Price Liste des prix
PB-BF18	18" / 45 cm Bassine Fiber - Wood / Fibres naturelles bassine, 18" / 45 cm, en bois	24	11	1.3	12	\$ 13.21
PB-BF24	24" / 60 cm Bassine Fiber - Wood / Fibres naturelles bassine, 24" / 60 cm en bois	32	15	1.7	12	\$ 17.30
PB-BF36	36" / 90 cm Bassine Fiber - Wood / Fibres naturelles bassine, 36" / 90 cm, en bois	48	22	2.6	6/1	\$ 30.37

RYNO STREET/ BARN PUSHBROOM

Extra coarse broom that is great for heavy duty sweeping

Ideal for street sweeping, cleaning gravel on roofs, and in the construction industry, or where coarse debris needs to be swept • Includes broom, brace and tapered handle • Sold assembled

BALAI-BROSSE DE RUE / GRANGE RYNO

Balai-brosse qui convient parfaitement à un balayage intensif.

Idéal pour le balayage des rues, du gravier sur les toitures et des débris grossiers ou encore dans l'industrie de la construction. • Comprend le balai, l'entretoise et le manche à bout fuselé • Assemblé



M2 Code Code M2	Description	Pack Wt LB (S) Poids (lb) (S)	Pack Wt KG Poids (kg)	Cubic Ft Pi3	Pack Contenu	List Price Liste des prix
PB-700-ST14	14" / 35 cm Ryno Street broom with brace and 60" handle / 14" / 35 cm Balai de rue Ryno avec entretoise et 60 po manche,	18.5	8.5		4	\$ 40.30
PB-700-ST16	16" / 40 cm Ryno Street broom with brace and 60" handle / 16" / 40 cm Balai de rue Ryno avec entretoise et 60 po manche,	18.5	8.5		4	\$ 44.24

STREET / BARN

- Extra coarse fiber broom
- Ideal for street sweeping, roofing, and the construction industry, or where coarse debris need to be swept



RUE ET GRANGE

- Balai à fibres extra dures
- Idéal pour balayer les rues, nettoyer le gravier sur les toitures et des débris grossiers ou encore dans l'industrie de la construction



M2 Code Code M2	Description	Pack Wt LB (S) Poids (lb) (S)	Pack Wt KG Poids (kg)	Cubic Ft Pi3	Pack Contenu	List Price Liste des prix
PB-ST14	14" / 35 cm Polypro Street/Barn - Wood - Head Only / Balai-brosse de rue / grange en polypropylène, 14" / 36 cm, en bois-tête seulement	33	15	1.8	12	\$ 14.90
PB-ST16	16" / 40 cm Polypro Street/Barn - Wood - Head Only / Balai-brosse de rue / grange en polypropylène, 16" / 40 cm, en bois-tête seulement	36	16	2.1	12	\$ 17.47
PB-ST14-54T	14" Poly-Pro - Wood Stable/Street Broom with 54" tapered handle / 14" balai-brosse écurie/rue en polypropylène avec manche conique 54"				6	\$ 26.36
PB-ST16-54T	16" Poly-Pro - Wood Stable/Street Broom with 54" tapered handle / 16" balai-brosse écurie/rue en polypropylène avec manche conique 54"				6	\$ 29.38



WOODEN HANDLES / MANCHES EN BOIS

**THREADED
À BOUT FILETÉ**



**METAL TIP
EMBOUT MÉTALLIQUE**



**TAPERED
À BOUT FUSELÉ**



**STRAIGHT CUT
DROIT**



BULLDOG CONNECTOR



M2 Code Code M2	Description	Pack Wt LB (S) Poids (lb) (S)	Pack Wt KG Poids (kg)	Cubic Ft Pi3	Pack Contenu	List Price Liste des prix
THREADED WOOD / EN BOIS, À BOUT FILETÉ						
FH-W348	Threaded Wooden 15/16" x 48" Handles / Manche en bois à bout fileté, 15/16 po x 48 po	17	7.6	.7	25/12	\$ 5.51
FH-W348-78	Threaded Wooden 7/8" x 48" Handles / Manche en bois à bout fileté, 7/8 po x 48 po	17	7.6	.7	25/12	\$ 4.40
FH-W354	Threaded Wooden 15/16" x 54" Handles / Manche en bois à bout fileté, 15/16 po x 54 po	22	10	.7	25/12	\$ 6.80
FH-W360	Threaded Wooden 15/16" x 60" Handles / Manche en bois à bout fileté, 15/16 po x 60 po	29.5	13	.75	25/12	\$ 7.83
THREADED METAL TIP / EMBOUT MÉTALLIQUE FILETÉ						
FH-W354MT	Metal threaded tip 15/16" x 54" / Embout métallique fileté, 15/16 po x 54 po	24.5	11	.7	25/12	\$ 9.30
FH-W360MT	Metal threaded tip 15/16" x 60" / Embout métallique fileté, 15/16 po x 60 po	26.5	12	.75	25/12	\$ 10.46
FH-W360-118MT	Metal threaded tip 1 1/8" x 60" / Embout métallique fileté, 1 1/8 po x 60 po	37	16.7	.80	25/12	\$ 13.85
FH-W396-MT	Metal threaded tip 15/16" x 96" / Embout métallique fileté, 15/16" po x 96 po	44	20	.80	25/12	\$ 19.55
TAPERED WOOD / EN BOIS, À BOUT FUSELÉ						
FH-W354-118T	Tapered 1-1/8" x 54" / À bout fuselé, 1-1/8 po x 54 po	33	15	1	25/12	\$ 9.95
FH-W360-118T	Tapered 1-1/8" x 60" / À bout fuselé 1-1/8 po x 60 po	39	18	1	25/12	\$ 10.15
FH-W360-1T	Tapered 1" x 60" / À bout fuselé 1 po x 60 po	37.5	17	1	25/12	\$ 9.89
STRAIGHT CUT / DROIT						
FH-W360NT	Straight cut 15/16" x 60" / Droit, 15/16 po x 60 po	28.5	13	.75	25/12	\$ 9.57
FH-W354NT-1	Straight cut 1" x 54" / Droit, 1 po x 54 po	28.5	13	.75	25/12	\$ 10.55
FH-W354-118NT-CH	Straight Cut Chucked 1-3/4 to 1" D 1-1/8" X 54" / Droit, 1-3/4 à 1 po P 1-1/8 po X 54 po	33	15	1	25/12	\$ 9.11
FH-W360-118NT-CH	Straight Cut Chucked 1-3/4 to 1" D 1-1/8" X 60" / Droit, 1-3/4 à 1 po P 1-1/8 po X 60 po	39	18	1	25/12	\$ 10.33
PB-BD700-60	1/8" Dia. Bulldog Connector Handle Only / Connecteur bulldog - manche seulement - 1/8" po				24	\$ 20.02

ACCESSORIES

THREADED TO TAPERED ADAPTER

ADAPTEUR POUR FILETÉ À CONIQUE

A truly versatile adapter that lets you modify a variety of handles for tools with tapered inserts

Un adaptateur vraiment polyvalent qui vous permet de modifier une variété de manches pour outils avec insertion conique.



WINDOW BRUSHES / ADAPTEUR POUR FILETÉ À CONIQUE

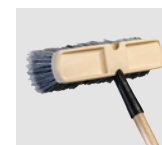

FIBERGLASS HEAVY DUTY HANDLE /



MANCHE EN FIBRE DE VERRE ROBUSTE

EXTENSION HANDLES / MANCHES EXTENSIBLES



WASHING SLEEVES / MANCHES DE LAVAGE



METAL FRAME SQUEEGEES / SUPPORTS DE RACLETTE EN MÉTAL



WINDOW SQUEEGEES / RACLETTES À VITRES



MOSS FLOOR SQUEEGEES / RACLOIR À PLANCHER "MOSS"



FH-A35

M2 Code Code M2	Description	Pack Wt LB (S) Poids (lb) (S)	Pack Wt KG Poids (kg)	Cubic Ft Pi3	Pack Contenu	List Price Liste des prix
FH-A35	Threaded to Tapered Adapter / Adaptateur conique fileté // Floor squeegee & window squeegees / Fuselé pour adaptateur fileté				12/1	\$ 3.37
FH-A36	Threaded To Locking Collar adapters / Floor squeegee & window squeegees / Fuselé pour adaptateur fileté				12/1	\$ 2.34



M2 Code Code M2	Description	Pack Wt LB (S) Poids (lb) (S)	Pack Wt KG Poids (kg)	Cubic Ft Pi3	Pack Contenu	List Price Liste des prix
METAL HANDLES / MANCHES EN MÉTAL						
FH-M336	7/8"/.875 cm - 36"/91 cm Yellow Metal handle with Threaded Tip And Hanger Cap - Black/Black / Manche jaune métallique à bout fileté, 7/8 po/.875 cm - 36"/91 cm avec capuchon de suspension - noir/noir	7.5	3.5	.5	24/12	\$ 5.20
FH-M348	7/8"/.875 cm - 48"/121 cm White Metal Handle with Threaded Tip And Hanger Cap / Manche blanc métallique à bout fileté de 7/8 po/.875 cm - 48 po/121 cm avec capuchon de suspension				24/12	\$ 3.33
FH-M348-EU-BL	7/8" / .875 cm x 48" / 121 cm Blue handle with EURO threaded tip and hanger cap / Manche noir; à bout fileté de 7/8 po / .875 cm x 48 po/ 121 cm avec capuchon de suspension				24/12	\$ 3.61
FH-M348-BK	7/8"/.875 cm - 48"/121 cm Black Handle with Threaded Tip And Hanger Cap / Manche noir; à bout fileté de 48"/121 cm avec capuchon de suspension				24/12	\$ 3.33
FH-M348-RD	7/8"/.875 cm - 48"/121 cm Red Handle with Threaded Tip And Hanger Cap / Manche rouge; à bout fileté de 48"/121 cm avec capuchon de suspension				24/12	\$ 3.33
FH-M336-2	2 Piece 36" Handle /				24/1	\$ 6.74
FH-M348-3	3 Piece 48" Handle /				24/1	\$ 7.44
HEX METAL HANDLES / POIGNÉE MÉTAL HEXAGONALE						
FH-M348HD-BK	1"/2.5 cm x 48"/121 cm Black Handle with Hex - Threaded tip and hanger cap - Heavy Duty / Manche noir à bout fileté de 1 po / 2.5 cm x 48 po / 121 avec capuchon de suspension-robuste				12/6	\$ 5.68
FH-M348HD-BL	1"/2.5 cm x 48"/121 cm Blue Handle with Hex - Threaded tip and hanger cap - Heavy Duty / Manche bleu à bout fileté de 1 po / 2.5 cm x 48 po / 121 cm avec capuchon de suspension-robuste				12/6	\$ 5.68
FH-M354HD-BK	1"/2.5 cm x 54"/137 cm Black Handle with Hex - Threaded tip and hanger cap Heavy Duty / Manche noir à bout fileté de 1 po / 2.5 cm x 54 po / 137 cm avec capuchon de suspension-robuste				12/6	\$ 6.13
FH-M360	1" / 2.5 cm - 60"/152 cm Blue Metal Handle with Hex with Threaded Tip And Hanger Cap / Roboste manche bleu à bout fileté de 1po/ 2.5 cm - 60"/152 cm avec capuchon de suspension-robuste	9	4	.6	12/6	\$ 6.70
FH-M360-BK	1"/2.5 cm x 60"/ 152 cm Black Metal handle with Hex and hanger cap - Threaded Tip / Manche bleu avec capuchon de suspension, droit et à bout non fileté en metal - 1 po/ 2.5 cm x 60 po/ 152 cm	9	4.5	.6	12/6	\$ 6.70
INTERNAL THREAD METAL HANDLES / POIGNÉES DE MÉTAL À FILETAGE INTERNE						
FH-M2354-HDBK	1"/2.5 cm x 54"/137 cm Black Handle with internal thread tip and hanger cap - Heavy Duty / Manche noir à bout fileté de 1 po / 2.5 cm x 54 po/137 cm avec capuchon de suspension-robuste				12/6	\$ 5.96
FH-M2360-HDBK	1"/2.5 cm x 60"/152 cm Black Handle with internal thread tip and hanger cap - Heavy Duty / Manche noir à bout fileté de 1 po / 2.5 cm x 60 po/ 152 cm avec capuchon de suspension-robuste				12/6	\$ 5.96
NO THREAD METAL HANDLES / POIGNÉES EN MÉTAL NON FILETÉES						
FH-M360-CH	1" / 2.5 cm - 60"/152 cm Blue Metal Handle with Hanger Cap Straight Cut - No Thread / Manche bleu avec capuchon de suspension, droit et à bout non fileté, 1 po / 2.5 cm - 60"/152 cm	9	4	.6	12/6	\$ 6.19
ALUMINUM HANDLES / MANCHE EN ALUMINIUM						
FH-A360	Aluminum non threaded handle 60" / Manche en aluminium non fileté 60"				12	\$ 10.83
FH-A361	Aluminum threaded handle 60" / Poignée filetée en aluminium 60"				12	\$ 15.31
FH-A3648-GN	Aluminum threaded handle 48" - Green / Poignée filetée en aluminium 48" - vert				12	\$ 20.71
FH-A360-Colours	Aluminum non threaded handle 60" - Coloured Grips/ Manche en aluminium non fileté 60" - Poignées de couleur				12	\$ 11.70
FH-A361-Colours	Aluminum threaded handle 60" - Coloured Grips/ Poignée filetée en aluminium 60" - Poignées de couleur				12	\$ 16.53

TELESCOPIC METAL HANDLES / MANCHES EN ET MÉTALLIQUE TÉLESCOPIQUE

FH-M378



43" / 109 cm / Extends to / Étend à 79" / 200 cm

FH-A3180



Closed 39" / 100cm - Extends to / Étend 70" / 180cm

FH-3160-T



M2 Code Code M2	Description	Pack Wt LB (S) Poids (lb) (S)	Pack Wt KG Poids (kg)	Cubic Ft Pi3	Pack Contenu	List Price Liste des prix
TELESCOPIC METAL HANDLE / MANCHE TÉLESCOPIQUE EN METAL						
FH-M378	Telescopic Threaded Metal Handle - 43 - 79", Ext 109-200 cm / Manche télescopique en metal 43 - 79", Ext 109 - 200 cm	9	4	.6	24/1	\$ 14.04
FH-M2748	Telescopic Handle Closed - 70cm/27.5" Ext - 122 cm / 48" - Green	9	4	.6	24/1	\$ 12.01
TELESCOPIC ALUMINIUM HANDLE - NON THREADED / MANCHE TÉLESCOPIQUE EN ALUMINIUM						
FH-A3160	Telescopic Handle (Closed 97 cm / 38") Extended 157 cm / 61"				1	\$ 22.74
FH-A3160-T	Telescopic Threaded Handle - 39" - 70"-100cm-180 cm / Manche télescopique fileté 39" - 70"-100cm-180 cm				20/1	\$ 27.41
FH-A3180	Telescopic Non Threaded Handle - 39" - 70"-100cm-180 cm / Manche télescopique non fileté 39" - 70"-100cm-180 cm				20/1	\$ 20.01



FIBERGLASS THREADED HANDLES / MANCHES DE FIBRE DE VERRE À BOUT FILETÉ

Constructed from strands of Fiberglass and a thermoset resin matrix that is molded and cured around the plastic honeycomb wall. Our handles are manufactured from a continuous one-piece structure that will not readily splinter, bend, or delaminate. They are lightweight yet remarkably strong – tensile strength of 80,000 lbs./ 36,287 Kg per square inch that will never warp or rot. As well, they are impervious to water, therefore electrically non-conductive.

Fabriqués à partir de brins de fibres de verre et d'une matrice de résine thermosettable qui est moulée et durcie autour d'une paroi en nid d'abeille en plastique. Les manches sont fabriqués à partir d'une pièce continue qui ne fendra pas, ne pliera pas et ne s'écaillera pas facilement. Ils sont légers, mais remarquablement solides. Leur résistance à la traction de 80 000 lb/ 36,287 Kg par pouce carré permet qu'ils ne se tordent ni ne moisissent. De plus, ils sont imperméables à l'eau, donc électriquement non conducteurs.



1"/2.5 CM DIAMETER
1"/2.5 CM DE DIAMÈTRE

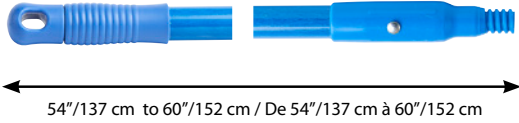

FH-F360-WH-HD



M2 Code Code M2	Description	Pack Wt LB (S) Poids (lb) (S)	Pack Wt KG Poids (kg)	Cubic Ft Pi3	Pack Contenu	List Price Liste des prix
FH-F330-WH	30"/76 cm Fiberglass Handle – White / Manche de fibre de verre, 30"/76 cm, blanc	15	6.7	.5	12	\$ 23.80
FH-F348-Colour	30"/76 cm Fiberglass Handle – WH, GN, BL, RD, YE / Manche de fibre de verre, 30"/76 cm, – WH, GN, BL, RD, YE	15	6.7	.5	12	\$ 23.80
FH-F354-BL	54"/137 cm -Fiberglass Handle – Blue / Manche de fibre de verre, 54"/137 cm bleu	15	6.7	.5	12	\$ 22.52
FH-F354-WH	54"/137 cm -Fiberglass Handle – White / Manche de fibre de verre, 54"/137 cm blanc	15	6.7	.5	12	\$ 22.52
FH-F360-BL	60"/152 cm Fiberglass Handle –Blue / Manche de fibre de verre, 60"/152 cm, BLue	16.5	7.5	.5	12	\$ 22.52
FH-F360-GN	60"/152 cm Fiberglass Handle – Green / Manche de fibre de verre, 60"/152 cm, vert	16.5	7.5	.5	12	\$ 22.52
FH-F360-WH	60"/152 cm Fiberglass Handle – White / Manche de fibre de verre, 60"/152 cm, blanc	16.5	7.5	.5	12	\$ 22.52
FH-F360-YL	60"/152 cm Fiberglass Handle – Yellow / Manche de fibre de verre, 60"/152 cm, jaune	16.5	7.5	.5	12	\$ 22.52
FH-F360-RD	60"/152 cm Fiberglass Handle – Red / Manche de fibre de verre, 60"/152 cm, rouge	16.5	7.5	.5	12	\$ 22.52
FH-F360-OR	60"/152 cm Fiberglass Handle – Orange / Manche de fibre de verre, 60"/152 cm, orange	16.5	7.5	.5	12	\$ 22.52
NON THREADED FIBERGLASS HANDLE - PLEASE SPECIFY COLOUR WHEN ORDERING / MANCHE EN FIBRE DE VERRE NON FILETÉ - S.V.P. SPÉCIFIÉ LA COULEUR LORS DE LA COMMANDE						
FH-F360NT-BL	1" x 60"/152 cm Fiberglass-Blue handle NoThread / Droit, Manche de fibre de verre, 1 po x 60 po /152 cm - bleu	16.5	7.5	.5	12/1	\$ 20.30
FH-F360-RD	1" x 60"/152 cm Fiberglass-Red handle NoThread / Droit, Manche de fibre de verre, 1 po x 60 po /152 cm - rouge	16.5	7.5	.5	12	\$ 21.32
FH-F360-GN	1" x 60"/152 cm Fiberglass-Green handle NoThread / Droit, Manche de fibre de verre, 1 po x 60 po /152 cm - vert	16.5	7.5	.5	12	\$ 21.32
FH-F360-YL	1" x 60"/152 cm Fiberglass-Yellow handle NoThread / Droit, Manche de fibre de verre, 1 po x 60 po /152 cm - jaune	16.5	7.5	.5	12	\$ 21.32
FH-F360-WH	1" x 60"/152 cm Fiberglass-White handle NoThread / Droit, Manche de fibre de verre, 1 po x 60 po /152 cm - blanc	16.5	7.5	.5	12	\$ 21.32
FH-F354NT1516-BL	54"/137 cm Fiberglass-Blue handle NoThread - 15/16"Dia. / Droit, Manche de fibre de verre, 54"/137 cm - 15/16 po-Dia.	16.5	7.5	.5	12/1	\$ 20.30
FH-F360NT1516-BL	60"/152 cm Fiberglass-Blue handle NoThread - 15/16"Dia. / Droit, Manche de fibre de verre, 60"/152 cm - 15/16 po-Dia.				12/1	\$ 19.99

ACCESSORIES / ACCESSOIRES TOOL BRACKET HOLDER / SUPPORT À OUTILS



- Tool Bracket helps you organize your maintenance tools
- 4 Adjustable brackets easily slide to accommodate a variety of tool widths
- Support à outils à attaches pour bien ranger les outils
- Quatre attaches réglables qui glissent facilement pour pouvoir mettre des outils de différentes largeurs.

Additional Clips can be added if required
Possibilité d'ajouter des attaches, le cas échéant



Measures 18" / 45 cm L – 2 7/8" / 7 cm – H X 2" / 5cm D
Mesure 18" / 45 cm L – 2 7/8" / 7 cm – H X 2" / 5cm D



M2 Code Code M2	Description	Pack Wt LB (S) Poids (lb) (S)	Pack Wt KG Poids (kg)	Cubic Ft Pi3	Pack Contenu	List Price Liste des prix
TL-101	Single Clip Holder Only / Attache de support à outils	3.6	1.6	.3	12/1	\$ 12.47
TL-104	4 Clip Tool Holder / Support à outils 4 attaches	10	5	1.2	12/1	\$ 38.72
FP-TL9110	10" Aluminum Tool Holder/Hanger / Blue, Red, Green, Yellow, White /	10	5	1.2	6/1	\$ 22.04

MOSS PLASTIC FLOOR SQUEEGEE PROFESSIONAL / RACLOIR À PLANCHER PROFESSIONNEL EN CAOUTCHOUC MOUSSE - CANNELURE PLASTIQUE

- With Natural Dura-flex Rubber
- Dura-Flex rubber is recommended when hygiene is extremely important. Ideal for applications within a HACCP system
- Available in 5 colors (blue, green, white, yellow and red)
- Ideal for applications within a HACCP system

- Caoutchouc naturel Dura-flex
- Le caoutchouc Dura-flex est recommandé où l'hygiène est très importante
- Disponible e 5 couleurs (bleu, vert, blanc, jaune et rouge)
- déale pour le système HACCP



Approuvé par la
FDA
Approved

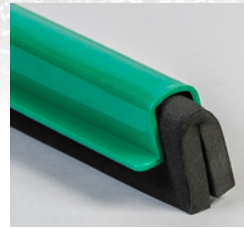

**100% CLOSED CELL RUBBER THAT WILL NOT
HARBOR BACTERIA /
FABRIQUÉ À 100% DE CAOUTCHOUC À CELLULES
FERMÉES QUI N'ABRITERA PAS LES BACTÉRIES**

M2 Code Code M2	Description	Pack Wt LB (S) Poids (lb) (S)	Pack Wt KG Poids (kg)	Cubic Ft Pi3	Pack Contenu	List Price Liste des prix
FS-MP24-WH	24"/60 cm Moss Plastic Squeegee with Natural Rubber - White / Raclette en caoutchouc mousse naturel - cannelure plastique, 24 po / 55cm -blanc				6/1	\$ 36.85
FS-MP24-GN	24"/60 cm Moss Plastic Squeegee with Natural Rubber - Green/ Raclette en caoutchouc mousse naturel - cannelure plastique, 24 po / 60cm -vert				6/1	\$ 36.85
FS-MP24-BL	24"/60cm Moss Plastic Squeegee with Natural Rubber - Blue / Raclette en caoutchouc mousse naturel - cannelure plastique, 24 po / 60cm -bleu				6/1	\$ 36.85
FS-MP24-RD	24"/60 cm Moss Plastic Squeegee with Natural Rubber - Red / Raclette en caoutchouc mousse naturel - cannelure plastique, 24 po / 60cm -rouge				6/1	\$ 36.85
FS-MP18-YE	18"/45 cm Moss Plastic Squeegee with Natural Rubber - Yellow / Raclette en caoutchouc mousse naturel - cannelure plastique, 18 po / 45cm -jaune				6/1	\$ 36.85
FS-MP24-YE	24"/60 cm Moss Plastic Squeegee with Natural Rubber - Yellow / Raclette en caoutchouc mousse naturel - cannelure plastique, 24 po / 60cm -jaune				6/1	\$ 36.85
FS-MP30-WH	30"/76 cm Moss Plastic Squeegee with Natural Rubber - White / Raclette en caoutchouc mousse naturel - cannelure plastique, 30 po / 76cm -blanc				6/1	\$ 43.52

HYGIENIC MONOBLADE SQUEEGES

Where hygiene is of primary importance to the food industry, professional kitchen, hospital, labs and pharmaceutical industry

RACLETTE HYGIÉNIQUE MONO-LAME

Où l'hygiène est d'une importance primordiale: l'industrie alimentaire, les cuisines professionnelles, les hôpitaux, les laboratoires et l'industrie pharmaceutique.

Smooth Water Flow /
Écoulement doux de l'eau

Approuvé par la
FDA
Approved

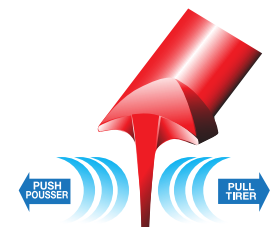

- Optimal socket handle design
- Protected soft touch edges
- Ideal for smooth surfaces
- Autoclavable 138o C / 280o F
- One piece squeegee: no hidden bacteria
- High tear and wear resistance
- Use for floor and walls

- Conception optimale de la poignée
- Bords Tactiles protégés
- Idéal pour les surfaces lisses
- Stérilisation à la vapeur 138C/280F
- Raclette d'une seule pièce: pas de bactérie cachée
- Haute résistance aux déchirures et à l'usure
- Utilisez pour les planchers et les murs



Colour coded handles
also available

Manches de couleur
aussi disponibles

FS-MB224-WH	24"/60 cm MonoBlade Floor Squeegee with Scraper - White / 24"/60 cm Raclette à plancher mono-lame avec racloir - blanc				6/1	\$ 113.52
FS-MB224-GN	24"/60 cm MonoBlade Floor Squeegee with Scraper - Green/ 24"/60 cm Raclette à plancher mono-lame avec racloir - vert				6/1	\$ 113.52
FS-MB224-BL	24"/60 cm MonoBlade Floor Squeegee with Scraper - Blue / 24"/60 cm Raclette à plancher mono-lame avec racloir -bleu				6/1	\$ 113.52
FS-MB224-RD	24"/60 cm MonoBlade Floor Squeegee with Scraper - Red / 24"/60 cm Raclette à plancher mono-lame avec racloir - rouge				6/1	\$ 113.52
FS-MB224-YE	24"/60 cm MonoBlade Floor Squeegee with Scraper - Yellow / 24"/60 cm Raclette à plancher mono-lame avec racloir - jaune				6/1	\$ 113.52



MOSS PROFESSIONAL PUSH-N-SCRUB PLASTIC FLOOR SQUEEGEE / RACLOIR À PLANCHER PROFESSIONNEL PUSH-N-SCRUB EN CAOUTCHOUC MOUSSE - CANNELURE PLASTIQUE



M2 Code Code M2	Description	Pack Wt LB (S) Poids (lb) (S)	Pack Wt KG Poids (kg)	Cubic Ft Pi3	Pack Contenu	List Price Liste des prix
PUSH-N-SCRUB PLASTIC FLOOR SQUEEGEE - PROFESSIONAL / RACLOIR À PLANCHER PROFESSIONNEL PUSH-N-SCRUB EN PLASTIQUE						
FS-MPS18	MOSS Push-N-Scrub Squeegee Plastic with Natural Rubber – 18"/45cm / Racloir à plancher en caoutchouc mousse naturel - cannelure plastique, 18 po / 45cm	7	3.1	.95	10/1	\$ 31.84
FS-MPS22	MOSS Push-N-Scrub Squeegee Plastic with Natural Rubber – 22"/55cm / Racloir Push-N-Scrub en caoutchouc mousse naturel - cannelure plastique, 22 po / 55cm	8	3.6	1.1	10/1	\$ 35.93

MOSS PROFESSIONAL FLOOR SQUEEGEE / RACLOIR À PLANCHER PROFESSIONNEL "MOSS"

* Handles Sold Separately
FH-F3541516NT-BL on Page 66

* Le manche est vendu séparément
* FH-F3541516NT-BL à la page 66



- M2 MOSS Professional Floor squeegees are corrosion – resistant polypropylene floor squeegee are ideal for removing water and dirt from any type of floor.
- Made of a double closed-cell foam rubber with a universal handle socket
- Soft rubber for colder environments

- Le raclette professionnelle M2 "MOSS" est résistant à la corrosion, le racloir à plancher en polypropylène est idéal pour éliminer l'eau et la saleté solide humide de tous les types de planchers.
- Fait d'une double mousse à cellules fermées avec une douille de manche universel.
- Caoutchouc souple pour les environnements plus froids

M2 Code Code M2	Description	Pack Wt LB (S) Poids (lb) (S)	Pack Wt KG Poids (kg)	Cubic Ft Pi3	Pack Contenu	List Price Liste des prix
FS-P4518	MOSS Professional Floor squeegee 18"/45cm / Raclette professionnelle "MOSS" 45cm/18"	21	9.9		10/1	\$ 19.48
FS-P5522	MOSS Professional Floor squeegee 22"/55cm / Raclette professionnelle "MOSS" 55cm/22"	22	10		10/1	\$ 22.46
FS-P7530	MOSS Professional Floor squeegee 30"/75cm / Raclette professionnelle "MOSS" 75cm/30"	29	13		10/1	\$ 29.76
FH-A36	Threaded To Locking Collar adapters / Floor squeegee & window squeegees / Adapteur de vissé a barré-racloir a plancher ou vitre				12/1	\$ 2.34

MOSS FLOOR SQUEEGEE / RACLOIR À PLANCHER "MOSS"



- Heavy duty floor squeegee with splash guard and reinforced handle socket
- Universal socket with built-in screw & nut - fits all straight and tapered handles with diameter less than 23 mm
- Perfect for professional use and to clean a large surface
- Metal frame: rust resistant galvanized steel
- Available in black and red natural Dura-Flex rubber

- Racloir à plancher robuste avec anti-éclaboussure et prise de manche renforcé
- La prise universelle avec vis et écrous intégrés convient à tous les manches droits et coniques avec un diamètre inférieur à 23mm.
- Parfait pour usage professionnel et le nettoyage de larges surfaces
- Cadre de métal : acier galvanisé résistant à la rouille
- Disponible en caoutchouc « Dura-Flex » noir et rouge



FH-W360-1T FH-F354NT1516-BL



FH-A36



FH-A37



Oil resistant
Résistant à l'huile



M2 Code Code M2	Description	Pack Wt LB (S) Poids (lb) (S)	Pack Wt KG Poids (kg)	Cubic Ft Pi3	Pack Contenu	List Price Liste des prix
MOSS FLOOR SQUEEGEE WITH UNIVERSAL HANDLE SOCKET (Screw & Nut) / RACLOIR À PLANCHER EN CAOUTCHOUC MOUSSE AVEC DOUILLE UNIVERSELLE (vis et écrou)						
FS-M622	MOSS Floor Squeegee with Natural Rubber – 22"/55 cm / FS-M18 Racloir à plancher en caoutchouc mousse naturel - 22 po / 55 cm	14.9	6.8	.35	10/1	\$ 12.17
FS-M18	MOSS Floor Squeegee with Natural Rubber – 18"/45 cm / FS-M18 Racloir à plancher en caoutchouc mousse naturel - 18 po / 45 cm	14.9	6.8	.35	10/1	\$ 12.17
FS-M22	MOSS Floor Squeegee with Natural Rubber – 22"/55 cm / Racloir à plancher en caoutchouc mousse naturel - 22 po / 55 cm	33.9	15.4	.44	10/1	\$ 17.18
MOSS HEAVY DUTY SQUEEGEE / SQUEEGEE MOSS ROBUSTE						
FS-MH18	MOSS Squeegee with Natural Rubber 18"/45 cm Heavy Duty / Raclette à plancher Robuste en caoutchouc mousse naturel -18 po / 45cm	15	7.2		10/1	\$ 24.05
FS-MH22	MOSS Squeegee with Natural Rubber 22"/55 cm Heavy Duty / Raclette à plancher Robuste en caoutchouc mousse naturel - 22 po / 55cm	34	15.4		10/1	\$ 27.15
FS-MH30	MOSS Heavy Duty Floor Squeegee with Natural Rubber – 30"/75 cm / Racloir à plancher robuste en caoutchouc mousse naturel - 30 po / 75 cm	34	7.26		10/1	\$ 35.46
FS-MH22-RD	MOSS Squeegee Heavy Duty with Neoprene Red Oil Resistant Rubber – 22"/55 cm Racloir à plancher robuste en caoutchouc mousse naturel - 22 po / 55 cm – rouge - Résistant à l'huile	34	15.4		10/1	\$ 31.31
FS-MH30-RD	MOSS Squeegee Heavy Duty with Neoprene Red Oil Resistant Rubber – 30"/75 cm Racloir à plancher robuste en caoutchouc mousse naturel - 30 po / 76 cm – rouge - Résistant à l'huile	34	15.4		10/1	\$ 47.42
MOSS SQUEEGEE HANDLES / MANCHE DE BOIS À BOUT FUSelé						
FH-W360-1T	Tapered 1" x 60" / À bout fuselé 1 po x 60 po			1	25/1	\$ 7.91
FH-F354NT1516-BL	Fiberglass Handle - No thread - 54" x 15/16" - Blue / Droit, Manche de fibre de verre, 54" x 15/16 po – bleu			1	12/1	\$ 19.99
FH-A36	Threaded To Locking Collar adapters / Floor squeegee & window squeegees / Adaptateur de vissé à barré-racloir a plancher ou vitre				12/1	\$ 2.34
FH-A35	Threaded to Tapered Adapter / Adaptateur conique fileté				12/1	\$ 3.37
FH-A37	Threaded Insert Only for Mus Metal Floor Squeegees / Embout fileté seulement pour Mus raclette à plancher métallique				10/1	\$ 4.13



METAL FRAME SQUEEGEES / CADRE MÉTALLIQUE DE RACLOIR DROIT



Straight Handle
Floor Squeegee uses
1 1/2" Tapered Handle



Poignée droite
Usages pour racloir
à plancher
Poignée conique
1 1/2"

24" Straight Floor Squeegee With
54" Tapered Handle Complete



* Handles Sold Separately
* Refer to page ----- Tapered Handle

* Le manche est vendu séparément
* Se reporter à la page ----- Poignées coniques

M2 Code Code M2	Description	Pack Wt LB (S) Poids (lb) (S)	Pack Wt KG Poids (kg)	Cubic Ft Pi3	Pack Contenu	List Price Liste des prix
STRAIGHT METAL FRAME SQUEEGEE / CADRE MÉTALLIQUE DE RACLOIR DROIT						
FS-S518	18"/45 cm Straight Floor Squeegee / Racloir à plancher droit, 18 po / 45 ccm	25	11	1.7	12	\$ 29.05
FS-S524	24"/60 cm Straight Floor Squeegee / Racloir à plancher droit, 24 po / 60 cm	29	13	2.4	12	\$ 32.01
FS-S530	30"/75 cm Straight Floor Squeegee / Racloir à plancher droit, 30 po / 75 ccm	25	11	1.7	6	\$ 54.01
FS-S536	36"/91 cm Straight Floor Squeegee / Racloir à plancher droit, 36 po / 91 cm	29	13	2.4	6	\$ 64.98
HEAVY DUTY CURVED SQUEEGEE / RACLOIR COURBÉ USAGE INTENSIF						
FS-C524	24"/60 cm Curved Floor Squeegee - Grey / Racloir à plancher courbé, 24 po / 60cm - gris	26	12	2.4	12	\$ 62.10
FS-C536	36"/91 cm Curved Floor Squeegee- Grey / Racloir à plancher courbé, 36 po / 91cm - gris	26	12	2.4	6	\$ 78.78
FLOOR SQUEEGEE STRAIGHT COMBO /						
FS-S524-54	24"/60 cm Straight Floor Squeegee with 54" Tapered Handle - Grey	.07	.03		12	\$ 44.44
TAPERED WOOD HANDLES FOR STRAIGHT & CURVED SQUEEGEES / MANCHES À BOUT FUSÉLÉ POUR LES RACLETTES DROITES OU COURBÉES						
FH-W354-118T	Tapered 1-1/8" x 54" / À bout fuselé 1-1/8 po x 54 po			1	25	\$ 7.96
FH-W360-118T	Tapered 1 1/8" x 60" / À bout fuselé 1 1/8 po x 60 po			1	25	\$ 8.36
FH-W360-1T	Tapered 1" x 54" / À bout fuselé 1 po x 54 po			1	25	\$ 7.91
SQUEEGEE REFILL / LAME DE RECHANGE						
FS-S18R	18"/45 cm Rubber Squeegee Refill / Lame de rechange de racloir en caoutchouc mousse, 18 po / 45 cm	.07	.03		48/1	\$
	24"/60 cm Rubber Squeegee Refill / Lame de rechange de en caoutchouc mousse, 24 po / 60 cm	.07	.03		24/1	\$



SUPER LOOPER - NARROW BAND / LA VADROUILLE SUPER LOOPER À BANDE ÉTROITE

HEADBAND COLOURS ON MOPS /
COULEUR DE LA BANDE DE
TÊTE SUR LES VADROUILLES



SMALL / PETIT



MEDIUM / MOYEN

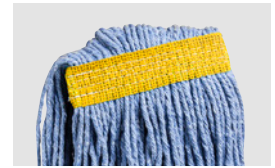

LARGE / MOYEN



X-LARGE / EXTRA-GRAND



M2 Code Code M2	Description	Pack Wt LB (S) Poids (lb) (S)	Pack Wt KG Poids (kg)	Cubic Ft Pi3	Pack Contenu	List Price Liste des prix
SUPER LOOPER – NARROW BAND – BLUE / SUPER LOOPER, BANDE ÉTROITE, bleu						
MW-SLR09XS-NB-BL	Super Looper - Extra Small - Narrow Band - Blue / Super Looper, super petit, bande étroite bleu	9.72	4.4	1	12	\$ 11.78
MW-SLR15-NB-BL	Super Looper - Small - Narrow Band - Blue / Super Looper, petite, bande étroite, bleu	10.8	5	1	12	\$ 12.73
MW-SLR2M-NB-BL	Super Looper - Medium - Narrow Band - Blue / Super Looper, moyenne, bande étroite, bleu	13.5	6	1.5	12	\$ 15.06
MW-SLR3L-NB-BL	Super Looper - Large - Narrow Band - Blue / Super Looper, grande, bande étroite, bleu	16	7	1.5	12	\$ 19.06
MW-SLR4XL-NB-BL	Super Looper - X-Large - Narrow Band - Blue / Super Looper, très grande, bande étroite, bleu	19	8.5	2	12	\$ 22.83
SUPER LOOPER – NARROW BAND – ORANGE / SUPER LOOPER, BANDE ÉTROITE, ORANGE						
MW-SLR15-NB-OR	Super Looper - Small - Narrow Band - Orange / Super Looper, petite, bande étroite, orange	10.8	5	1	12	\$ 12.73
MW-SLR2M-NB-OR	Super Looper - Medium - Narrow Band - Orange / Super Looper, moyenne, bande étroite, orange	13.5	6	1.5	12	\$ 15.06
MW-SLR3L-NB-OR	Super Looper - Large - Narrow Band - Orange / Super Looper, grande, bande étroite, orange	16	7	1.5	12	\$ 19.06
MW-SLR4XL-NB-OR	Super Looper - X-Large - Narrow Band - Orange / Super Looper, très grande, bande étroite, orange	19	8.5	2	12	\$ 22.83
SUPER LOOPER – NARROW BAND – GREEN / SUPER LOOPER, BANDE ÉTROITE, verte						
MW-SLR15-NB-GN	Super Looper - Small - Narrow Band - Green / Super Looper, petite, bande étroite, verte	10.8	5	1	12	\$ 12.73
MW-SLR2M-NB-GN	Super Looper - Medium - Narrow Band - Green / Super Looper, moyenne, bande étroite, verte	13.5	6	1.5	12	\$ 15.06
MW-SLR3L-NB-GN	Super Looper - Large - Narrow Band - Green / Super Looper, grande, bande étroite, verte	16	7	1.5	12	\$ 19.06
MW-SLR4XL-NB-GN	Super Looper - X-Large - Narrow Band - Green / Super Looper, très grande, bande étroite, verte	19	8.5	2	12	\$ 22.83
SUPER LOOPER – NARROW BAND – WHITE / SUPER LOOPER, BANDE ÉTROITE, blanche						
MW-SLR15-NB-WH	Super Looper - Small - Narrow Band - White / Super Looper, petite, bande étroite, blanc	10.8	5	1	12	\$ 12.73
MW-SLR2M-NB-WH	Super Looper - Medium - Narrow Band - White / Super Looper, moyenne, bande étroite, blanche	13.5	6	1.5	12	\$ 15.06
MW-SLR3L-NB-WH	Super Looper - Large - Narrow Band - White / Super Looper, grande, bande étroite, blanche	16	7	1.5	12	\$ 19.06
MW-SLR4XL-NB-WH	Super Looper - X-Large - Narrow Band - White / Super Looper, très grande, bande étroite, blanche	19	8.5	2	12	\$ 22.83





SUPER LOOPER - WIDE BAND / LA VADROUILLE SUPER LOOPER À BANDE LARGE

HEADBAND COLOURS ON MOPS /
COULEUR DE LA BANDE DE
TÊTE SUR LES VADROUILLES

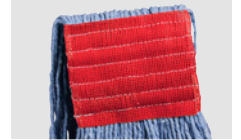

MINI / MINI



SMALL / PETIT



MEDIUM / MEDIUM



LARGE / MEDIUM



X-LARGE / EXTRA-GRAND

M2 Code Code M2	Description	Pack Wt LB (S) Poids (lb) (S)	Pack Wt KG Poids (kg)	Cubic Ft Pi3	Pack Contenu	List Price Liste des prix
SUPER LOOPER – WIDE BAND – BLUE / SUPER LOOPER, BANDE LARGE, BLEU						
MW-SLR09XS-WB-BL	Super Looper - Mini - Wide Band - Blue / Super Looper, Mini, bande large, bleu	9.72	4.4	1	12	\$ 12.95
MW-SLR10S-WB-BL	Super Looper - Small - Wide Band - Blue / Super Looper, petite, bande large, bleu	10.8	5	1	12	\$ 13.58
MW-SLR11M-WB-BL	Super Looper - Medium - Wide Band - Blue / Super Looper, moyenne, bande large, bleu	13.5	6	1.5	12	\$ 15.79
MW-SLR12L-WB-BL	Super Looper - Large - Wide Band - Blue / Super Looper, grande, bande large, bleu	16	7	1.5	12	\$ 19.42
MW-SLR13XL-WB-BL	Super Looper - X-Large - Wide Band - Blue / Super Looper, très grande, bande large, bleu	19	8.5	2	12	\$ 23.45
SUPER LOOPER – WIDE BAND – ORANGE / SUPER LOOPER, BANDE LARGE, ORANGE						
MW-SLR10S-WB-OR	Super Looper - Small - Wide Band - Orange / Super Looper, petite, bande large, orange	10.8	5	1	12	\$ 13.58
MW-SLR11M-WB-OR	Super Looper - Medium - Wide Band - Orange / Super Looper, moyenne, bande large, orange	13.5	6	1.5	12	\$ 15.79
MW-SLR12L-WB-OR	Super Looper - Large - Wide Band - Orange / Super Looper, grande, bande large, orange	16	7	1.5	12	\$ 19.42
MW-SLR13XL-WB-OR	Super Looper - X-Large - Wide Band - Orange / Super Looper, très grande, bande large, orange	19	8.5	2	12	\$ 23.45
SUPER LOOPER – WIDE BAND – GREEN / SUPER LOOPER, BANDE LARGE, VERT						
MW-SLR10S-WB-GN	Super Looper - Small - Wide Band - Green / Super Looper, petite, bande large, verte	10.8	5	1	12	\$ 13.58
MW-SLR11M-WB-GN	Super Looper - Medium - Wide Band - Green / Super Looper, moyenne, bande large, verte	13.5	6	1.5	12	\$ 15.79
MW-SLR12L-WB-GN	Super Looper - Large - Wide Band - Green / Super Looper, grande, bande large, verte	16	7	1.5	12	\$ 19.42
MW-SLR13XL-WB-GN	Super Looper - X-Large - Wide Band - Green / Super Looper, très grande, bande large, verte	19	8.5	2	12	\$ 23.45
SUPER LOOPER – WIDE BAND – WHITE / SUPER LOOPER, BANDE LARGE, BLANC						
MW-SLR10S-WB-WH	Super Looper - Small - Wide Band - White / Super Looper, petite, bande large, blanche	10.8	5	1	12	\$ 13.58
MW-SLR11M-WB-WH	Super Looper - Medium - Wide Band - White / Super Looper, moyenne, bande large, blanche	13.5	6	1.5	12	\$ 15.79
MW-SLR12L-WB-WH	Super Looper - Large - Wide Band - White / Super Looper, grande, bande large, blanche	16	7	1.5	12	\$ 19.42
MW-SLR13XL-WB-WH	Super Looper - X-Large - Wide Band - White / Super Looper, très grande, bande large, blanche	19	8.5	2	12	\$ 23.45



SWINGER™ / VADROUILLE SWINGER^{MD}

LOOPED END WET MOP / VADROUILLE À FRANGES BOUCLÉES COUPÉS

- Swinger mops are made with 4 ply Rayon blended yarns that can withstand repeated launderings
- Break-in is not necessary
- This highly absorbent mop with mid-range retention is perfect for general any cleaning or any building contractor environments
- Les vadrouilles Swinger sont fabriquées avec un mélange rayonne / fibres synthétiques 4 fils qui peuvent résister à des blanchissages à répétition.
- Ne requiert pas de préparation préalable à l'utilisation.
- Cette vadrouille très absorbante, à rétention moyenne, convient parfaitement au nettoyage général ou dans le milieu de entrepreneur en bâtiment.

SWINGER - LOOPED / FRANGES BOUCLÉES										
	1	2	3	4	5	6	7	8	9	10
Durability / Durabilité										
Absorbency / Absorption										
Release / Capacité D'Évacuation										
Launderability / Blanchiment										
Performance / Performance										



HEADBAND COLOURS ON NARROW BAND MOPS / COULEURS SUR LA BANDE DE TÊTE SUR LES VADROUILLES À BANDES ÉTROITES



SMALL / PETIT



MEDIUM / MOYEN



LARGE / GRAND



X-LARGE / EXTRA-GRAND

HEADBAND COLOURS ON WIDE BAND MOPS / COULEURS DE LA BANDE DE TÊTE SUR LES VADROUILLES À BANDE LARGE



SMALL / PETIT



MEDIUM / MOYEN



LARGE / GRAND



X-LARGE / EXTRA-GRAND

M2 Code Code M2	Description	Pack Wt LB (S) Poids (lb) (S)	Pack Wt KG Poids (kg)	Cubic Ft Pi³	Pack Contenu	List Price Liste des prix
SWINGER – LOOPED – NARROW BAND / SWINGER, À FRANGES BOUCLÉES, BANDE ÉTROITE						
MW-SW1S-NB-BL	Swinger – Small – Narrow Band – Blue / Swinger, petite, bande étroite, bleu	11	5	1.3	12	\$ 12.08
MW-SW2M-NB-BL	Swinger – Medium – Narrow Band – Blue / Swinger, moyenne, bande étroite, bleu	13	6	1.6	12	\$ 13.55
MW-SW3L-NB-BL	Swinger – Large – Narrow Band – Blue / Swinger, grande, bande étroite, bleu	16	7	1.6	12	\$ 15.59
MW-SW4XL-NB-BL	Swinger – Extra Large – Narrow Band – Blue / Swinger, très grande, bande étroite, bleu	19	8.5	2.2	12	\$ 18.08
SWINGER – LOOPED – WIDE BAND / SWINGER, À FRANGES BOUCLÉES, BANDE LARGE						
MW-SW10S-WB-BL	Swinger – Small – Wide Band – Blue / Swinger, petite, bande large, bleu	11	5	1.3	12	\$ 12.74
MW-SW11M-WB-BL	Swinger – Medium – Wide Band – Blue / Swinger, moyenne, bande large, bleu	13	6	1.6	12	\$ 14.15
MW-SW12L-WB-BL	Swinger – Large – Wide Band – Blue / Swinger, grande, bande large, bleu	16	7	1.6	12	\$ 14.85
MW-SW13XL-WB-BL	Swinger – Extra Large – Wide Band – Blue / Swinger, très grande, bande large, bleu	19	8.5	2.2	12	\$ 16.26



SWINGER™ / VADROUILLE SWINGER^{MD}

LOOPED END WET MOP / VADROUILLE À FRANGES BOUCLÉES



HEADBAND COLOURS ON SWINGER MOPS /
COULEURS DE LA BANDE DE TÊTE SUR LES
VADROUILLES SWINGER



SMALL / PETIT

MEDIUM / MOYEN

LARGE / GRAND

X-LARGE / EXTRA-GRAND

M2 Code Code M2	Description	Pack Wt LB (S) Poids (lb) (S)	Pack Wt KG Poids (kg)	Cubic Ft Pi3	Pack Contenu	List Price Liste des prix
SWINGER – LOOPED – NARROW BAND / SWINGER, À FRANGES BOUCLÉES, BANDE ÉTROITE						
MW-SW1S-NB-GN	Swinger – Small – Narrow Band – Green / Swinger, petite, bande étroite, vert	11	5	1.3	12	\$ 10.76
MW-SW2M-NB-GN	Swinger – Medium – Narrow Band – Green / Swinger, moyenne, bande étroite, vert	13	6	1.6	12	\$ 12.07
MW-SW3L-NB-GN	Swinger – Large – Narrow Band – Green / Swinger, grande, bande étroite, vert	16	7	1.6	12	\$ 13.89
MW-SW4XL-NB-GN	Swinger – Extra Large – Narrow Band – Green / Swinger, très grande, bande étroite, vert	19	8.5	2.2	12	\$ 16.10
SWINGER – LOOPED – WIDE BAND / SWINGER, À FRANGES BOUCLÉES, BANDE LARGE						
MW-SW10S-WB-GN	Swinger – Small – Wide Band – Green / Swinger, petite, bande large, vert	11	5	1.3	12	\$ 11.34
MW-SW11M-WB-GN	Swinger – Medium – Wide Band – Green / Swinger, moyenne, bande large, vert	16	6	1.6	12	\$ 12.60
MW-SW12L-WB-GN	Swinger – Large – Wide Band – Green / Swinger, grande, bande large, vert	16	7	1.6	12	\$ 14.48
MW-SW13XL-WB-GN	Swinger – Extra Large – Wide Band – Green / Swinger, très grande, bande large, vert	19	8.5	2.2	12	\$ 16.71



HEADBAND COLOURS ON SWINGER MOPS /
COULEURS DE LA BANDE DE TÊTE SUR LES
VADROUILLES SWINGER



SMALL / PETIT

MEDIUM / MOYEN

LARGE / GRAND

X-LARGE / EXTRA-GRAND

M2 Code Code M2	Description	Pack Wt LB (S) Poids (lb) (S)	Pack Wt KG Poids (kg)	Cubic Ft Pi3	Pack Contenu	List Price Liste des prix
SWINGER – LOOPED – NARROW BAND / SWINGER, À FRANGES BOUCLÉES, BANDE ÉTROITE						
MW-SW1S-NB-OR	Swinger – Small – Narrow Band – Orange / Swinger, petite, bande étroite, orange	11	5	1.3	12	\$ 10.76
MW-SW2M-NB-OR	Swinger – Medium – Narrow Band – Orange / Swinger, moyenne, bande étroite, orange	13	6	1.6	12	\$ 12.07
MW-SW3L-NB-OR	Swinger – Large – Narrow Band – Orange / Swinger, grande, bande étroite, orange	16	7	1.6	12	\$ 13.89
MW-SW4XL-NB-OR	Swinger – Extra Large – Narrow Band – Orange / Swinger, très grande, bande étroite, orange	19	8.5	2.2	12	\$ 16.10
SWINGER – LOOPED – WIDE BAND / SWINGER, À FRANGES BOUCLÉES, BANDE LARGE						
MW-SW10S-WB-OR	Swinger – Small – Wide Band – Orange / Swinger, petite, bande large, orange	11	5	1.3	12	\$ 11.34
MW-SW11M-WB-OR	Swinger – Medium – Wide Band – Orange / Swinger, moyenne, bande large, orange	13	6	1.6	12	\$ 12.60
MW-SW12L-WB-OR	Swinger – Large – Wide Band – Orange / Swinger, grande, bande large, orange	16	7	1.6	12	\$ 14.48
MW-SW13XL-WB-OR	Swinger – Extra Large – Wide Band – Orange / Swinger, très grande, bande large, orange	19	8.5	2.2	12	\$ 16.71

SWINGER™ TRUE WEIGHT / 'SWINGER™ MD " POIDS RÉEL

LOOPED END WET MOP / VADROUILLE À FRANGES BOUCLÉES COUPÉS

- Swinger mops are made with 4 ply Rayon blended yarns that can withstand repeated launderings
- Break-in is not necessary
- This highly absorbent mop with mid-range retention is perfect for general any cleaning or any building contractor environments
- Les vadrouilles Swinger sont fabriquées avec un mélange rayonne / fibres synthétiques 4 fils qui peuvent résister à des blanchissages à répétition.
- Ne requiert pas de préparation préalable à l'utilisation.
- Cette vadrouille très absorbante, à rétention moyenne, convient parfaitement au nettoyage général ou dans le milieu de neur en bâtiment.

SWINGER - LOOPED / FRANGES BOUCLÉES										
	1	2	3	4	5	6	7	8	9	10
Durability / Durabilité										
Absorbency / Absorption										
Release / Capacité d'évacuation										
Launderability / Blanchiment										
Performance / Performance										



HEADBAND COLOURS ON NARROW BAND MOPS / COULEURS SUR LA BANDE DE TÊTE SUR LES VADROUILLES À BANDES ÉTROITES



HEADBAND COLOURS ON WIDE BAND MOPS / COULEURS DE LA BANDE DE TÊTE SUR LES VADROUILLES À BANDE LARGE



M2 Code	Description	Pack Wt LB (S)	Pack Wt KG	Cubic Ft	Pack Contenu	List Price
Code M2		Poids (lb) (S)	Poids (kg)	Pi³		Liste des prix
SWINGER TRUE WEIGHT – LOOPED – NARROW BAND / SWINGER, À FRANGES BOUCLÉES, BANDE ÉTROITE						
MW-SW12-NB-BL	Swinger – True Weigh, Looped End– Narrow Band – Blue - 12oz/350g "Swinger" poids réel – embouts bouclés – bande étroite – bleu – 12 on. / 350 gr	11	5	1.3	12	\$ 12.91
MW-SW16-NB-BL	Swinger – True Weigh, Looped End– Narrow Band – Blue - 16oz/450g "Swinger" poids réel – embouts bouclés – bande étroite – bleu – 16oz/450g	13	6	1.6	12	\$ 14.73
MW-SW20-NB-BL	Swinger – True Weigh, Looped End– Narrow Band – Blue - 20oz/550g "Swinger" poids réel – embouts bouclés – bande étroite – bleu – 20oz/550g	16	7	1.6	12	\$ 16.64
MW-SW24-NB-BL	Swinger – True Weigh, Looped End– Narrow Band – Blue - 24oz/650g "Swinger" poids réel – embouts bouclés – bande étroite – bleu – 24oz/650g	19	8.5	2.2	12	\$ 19.11
MW-SW32-NB-BL	Swinger – True Weigh, Looped End– Narrow Band – Blue - 32oz/850g "Swinger" poids réel – embouts bouclés – bande étroite – bleu – 32oz/850g					\$ 23.00
SWINGER – LOOPED – WIDE BAND / SWINGER, À FRANGES BOUCLÉES, BANDE LARGE						
MW-SW12-WB-BL	Swinger – True Weigh, Looped End– Wide Band – Blue - 12oz/350g "Swinger" poids réel – embouts bouclés – bande large – bleu – 12 on. / 350 gr	11	5	1.3	12	\$ 13.91
MW-SW16-WB-BL	Swinger – True Weigh, Looped End– Wide Band – Blue - 16oz/450g "Swinger" poids réel – embouts bouclés – bande large – bleu – 16oz/450g	13	6	1.6	12	\$ 15.73
MW-SW20-WB-BL	Swinger – True Weigh, Looped End– Wide Band – Blue - 20oz/550g "Swinger" poids réel – embouts bouclés – bande large – bleu – 20oz/550g	16	7	1.6	12	\$ 17.64
MW-SW24-WB-BL	Swinger – True Weigh, Looped End– Wide Band – Blue - 24oz/650g "Swinger" poids réel – embouts bouclés – bande large – bleu – 24oz/650g	19	8.5	2.2	12	\$ 20.11
MW-SW32-WB-BL	Swinger – True Weigh, Looped End– Wide Band – Blue - 32oz/850g "Swinger" poids réel – embouts bouclés – bande large – bleu – 2oz/850g					\$ 24.90



SWIPE™ / VADROUILLE SWIPE^{MD}

CUT END / BOUPE

- Swipe mops are made with 4 ply Rayon blended yarns
- Break-in is not necessary
- This highly absorbent mop with medium retention is perfect for any general any cleaning or restaurant environments

- Les vadrouilles "Swipe" sont fabriquées de fibres mélangées 4 plis
- Ne requiert pas de préparation préalable à l'utilisation.
- Cette vadrouille très absorbante, à rétention moyenne, convient parfaitement au nettoyage général ou dans le milieu de la restauration.

SWIPE - CUT END / BRINS COUPÉS		1	2	3	4	5	6	7	8	9	10
Durability / Durabilité											
Absorbency / Absorption											
Release / Capacité D'Évacuation											
Launderability / Blanchiment											
Performance / Performance											



HEADBAND COLOURS ON SWIPE MOPS / COULEURS DE LA BANDE DE TÊTE SUR LES VADROUILLES SWIPE

12 OZ

16 OZ

20 OZ

24 OZ

28 OZ

32 OZ



M2 Code Code M2	Description	Pack Wt LB (5) Poids (lb) (5)	Pack Wt KG Poids (kg)	Cubic Ft Pi3	Pack Contenu	List Price Liste des prix
SWIPE – CUT END – NARROW BAND - BLUE / SWIPE, À FRANGES BOUCLÉES, BANDE ÉTROITE - bleu						
MW-SWC12-BL	Swipe – Cut End Mop 12 oz – NB – Blue / Swipe, à brins coupés, 12 oz, bande étroite - bleu	9	4	1	12	\$ 9.51
MW-SWC16-BL	Swipe – Cut End Mop 16 oz – NB – Blue / Swipe, à brins coupés, 16 oz, bande étroite - bleu	11	5	1.3	12	\$ 9.86
MW-SWC20-BL	Swipe – Cut End Mop 20 oz – NB – Blue / Swipe, à brins coupés, 20 oz, bande étroite - bleu	13	6	1.6	12	\$ 11.72
MW-SWC24-BL	Swipe – Cut End Mop 24 oz – NB – Blue / Swipe, à brins coupés, 24 oz, bande étroite - bleu	16.5	7	1.6	12	\$ 13.64
MW-SWC28-BL	Swipe – Cut End Mop 28 oz – NB – Blue / Swipe, à brins coupés, 28 oz, bande étroite - bleu	16.5	7	1.6	12	\$ 15.60
MW-SWC32-BL	Swipe – Cut End Mop 32 oz – NB – Blue / Swipe, à brins coupés, 32 oz, bande étroite - bleu	19	8.5	2.2	12	\$ 17.21
SWIPE – CUT END – NARROW BAND - GREEN / SWIPE, À FRANGES BOUCLÉES, BANDE LARGE - vert						
MW-SWC16-GN	Swipe – Cut End Mop 16 oz – NB – Green / Swipe, à brins coupés, 16 oz, bande étroite - vert	11	5	1.3	12	\$ 9.86
MW-SWC20-GN	Swipe – Cut End Mop 20 oz – NB – Green / Swipe, à brins coupés, 20 oz, bande étroite - vert	13	6	1.6	12	\$ 11.72
MW-SWC24-GN	Swipe – Cut End Mop 24 oz – NB – Green / Swipe, à brins coupés, 24 oz, bande étroite - vert	16.5	7	1.6	12	\$ 13.64
MW-SWC28-GN	Swipe – Cut End Mop 28 oz – NB – Green / Swipe, à brins coupés, 28 oz, bande étroite - vert	16.5	7	1.6	12	\$ 15.60
MW-SWC32-GN	Swipe – Cut End Mop 32 oz – NB – Green / Swipe, à brins coupés, 32 oz, bande étroite - vert	19	8.5	2.2	12	\$ 17.21
SWIPE – CUT END – NARROW BAND - ORANGE / SWIPE, À BRINS COUPÉS, BANDE ÉTROITE - orange						
MW-SWC16-OR	Swipe – Cut End Mop 16 oz – NB – Orange / Swipe, à brins coupés, 16 oz, bande étroite - orange	11	5	1.3	12	\$ 9.86
MW-SWC20-OR	Swipe – Cut End Mop 20 oz – NB – Orange / Swipe, à brins coupés, 20 oz, bande étroite - orange	13	6	1.6	12	\$ 11.72
MW-SWC24-OR	Swipe – Cut End Mop 24 oz – NB – Orange / Swipe, à brins coupés, 24 oz, bande étroite - orange	16.5	7	1.6	12	\$ 13.64
MW-SWC28-OR	Swipe – Cut End Mop 28 oz – NB – Orange / Swipe, à brins coupés, 28 oz, bande étroite - orange	16.5	7	1.6	12	\$ 15.60
MW-SWC32-OR	Swipe – Cut End Mop 32 oz – NB – Orange / Swipe, à brins coupés, 32 oz, bande étroite - orange	19	8.5	2.2	12	\$ 17.21

MICROPET MICROFIBER ECO SERIES MOPS MICROPET EN MICROFIBRE SÉRIE DE VADROUILLES ECO



MICROPET - LOOPED / FRANGES BOUCLÉES										
	1	2	3	4	5	6	7	8	9	10
Durability / Durabilité										
Absorbency / Absorption										
Release / Capacité D'Évacuation										
Launderability / Blanchiment										
Performance / Performance										

MICROPET - CUT END / BRINS COUPÉS										
	1	2	3	4	5	6	7	8	9	10
Durability / Durabilité										
Absorbency / Absorption										
Release / Capacité D'Évacuation										
Launderability / Blanchiment										
Performance / Performance										

**MADE FROM 100%
RECYCLED MATERIAL**



**ENTIÈREMENT
FABRIQUÉE AVEC DES
MATÉRIAUX RECYCLÉS**

- This highly absorbent mop with mid-range retention is perfect for any general cleaning application
- High resistance to chemicals and disinfectants
- Break-in is not necessary
- Made with next generation Microfiber and PET plastic soda bottles, this mop can be used in Healthcare environments
- Cette vadrouille très absorbante, à rétention moyenne, convient parfaitement au nettoyage général
- Résistance élevée aux produits chimiques et aux désinfectants
- Ne requiert pas de préparation préalable à l'utilisation
- Fabriquée avec des microfibres de nouvelle génération et des bouteilles de boissons gazeuses post-consommation en plastique (PET), cette vadrouille est très appréciée en milieu hospitalier

MICROPET MICROFIBER ECO SERIES MOPS / VADROUILLES SÉRIES ECO EN MICROFIBRE "MICROPET"



HEADBAND COLOURS ON MICROPET MOPS / COULEURS DE LA BANDE DE TÊTE DE LA VADROUILLE MICROPET



M2 Code Code M2	Description	Pack Wt LB (5) Poids (lb) (5)	Pack Wt KG Poids (kg)	Cubic Ft Pi3	Pack Contenu	List Price Liste des prix
MICROPET LOOPED END – NARROW BAND / MICROPET À FRANGES BOUCLÉES, BANDE ÉTROITE						
MW-MPE1S-NB	MicroPET Looped End – Small – Narrow Band / MicroPET, à franges bouclées, petite, bande étroite	11	5	1.3	12	\$ 11.58
MW-MPE2M-NB	MicroPET Looped End – Medium – Narrow Band / MicroPET, à franges bouclées, moyenne, bande étroite	13	6	1.6	12	\$ 16.44
MW-MPE3L-NB	MicroPET Looped End – Large – Narrow Band / MicroPET, à franges bouclées, grande, bande étroite	16	7	1.6	12	\$ 19.96
MW-MPE4XL-NB	MicroPET Looped End – Extra Large – Narrow Band / MicroPET, à franges bouclées, très grande, bande étroite	19	8.5	2.2	12	\$ 24.35
MICROPET LOOPED END – WIDE BAND / MICROPET À FRANGES BOUCLÉES, BANDE LARGE						
MW-MPE10S-WB	MicroPET Looped End – Small – Wide Band / MicroPET, à franges bouclées, petite, bande large	11	5	1.3	12	\$ 14.60
MW-MPE11M-WB	MicroPET Looped End – Medium – Wide Band / MicroPET, à franges bouclées, moyenne, bande large	13	6	1.6	12	\$ 16.94
MW-MPE12L-WB	MicroPET Looped End – Large – Wide Band / MicroPET, à franges bouclées, grande, bande large	16	7	1.6	12	\$ 21.03
MW-MPE13XL-WB	MicroPET Looped End – Extra Large – Wide Band / MicroPET, à franges bouclées, très grande, bande large	19	8.5	2.2	12	\$ 24.84
MICROPET CUT END – NARROW BAND / MICROPET À BRINS COUPÉS, BANDE ÉTROITE						
MW-MPEC12	12 oz. MicroPET Cut End – Narrow Band / MicroPET, à brins coupés, bande étroite	9	5.9	1.3	12	\$ 7.69
MW-MPEC16	16 oz. MicroPET Cut End – Narrow Band / MicroPET, à brins coupés, bande étroite	13	5.9	1.3	12	\$ 9.41
MW-MPEC20	20 oz. MicroPET Cut End – Narrow Band / MicroPET, à brins coupés, bande étroite	15	6.8	1.6	12	\$ 11.17
MW-MPEC24	24 oz. MicroPET Cut End – Narrow Band / MicroPET, à brins coupés, bande étroite	18	8.1	1.6	12	\$ 12.73
MW-MPEC32	32 oz. MicroPET Cut End – Narrow Band / MicroPET, à brins coupés, bande étroite	24	10.8	2.2	12	\$ 16.63
MICROPET CUT END – WIDE BAND / MICROPET À BRINS COUPÉS, BANDE LARGE						
MW-MPEC12-WB	12 oz. MicroPET Cut End – Wide Band / MicroPET, à brins coupés, bande large	13	6	1.3	12	\$ 10.26
MW-MPEC16-WB	16 oz. MicroPET Cut End – Wide Band / MicroPET, à brins coupés, bande large	15	7	1.6	12	\$ 12.24
MW-MPEC20-WB	20 oz. MicroPET Cut End – Wide Band / MicroPET, à brins coupés, bande large	18	8	1.6	12	\$ 14.21
MW-MPEC24-WB	24 oz. MicroPET Cut End – Wide Band / MicroPET, à brins coupés, bande large	20	9	1.7	12	\$ 16.30
MW-MPEC32-WB	32 oz. MicroPET Cut End – Wide Band / MicroPET, à brins coupés, bande large	24	11	2.2	12	\$ 20.43

SYNRAY™

CUT END & LOOPED END WET MOPS



- * All SynRay Narrow Band Mops
4 Row Stitched
- * All SynRay Wide Band Mops
6 Row Stitched
- * Toutes les vadrouilles SynRay à bande étroite ont 4 rangées de couture
- * Toutes les vadrouilles SynRay à bande large ont 6 rangées de couture

SYNRAY - LOOPED / FRANGES BOUCLÉES										
	1	2	3	4	5	6	7	8	9	10
Durability / Durabilité										
Absorbency / Absorption										
Release / Capacité D'Évacuation										
Launderability / Blanchiment										
Performance / Performance										

VADROUILLES HUMIDES À BRINS COUPÉS ET À FRANGES BOUCLÉES

HEADBAND COLOURS ON SYNRAY MOPS / COULEURS DE LA BANDE DE TÊTE DE LA VADROUILLE SYNRAY



M2 Code	Description	Pack Wt LB (S)	Pack Wt KG	Cubic Ft	Pack	List Price
Code M2		Poids (lb) (S)	Poids (kg)	Pi3	Contenu	Liste des prix
SYNRAY – CUT END – NARROW BAND – WITHOUT BAG / SYNRAY, À BRINS COUPÉS, BANDE ÉTROITE, SANS SAC						
MW-SC12	SYNRAY – Cut End – Narrow Band– 12 oz / 350 g / SYNRAY, à brins coupés, bande étroite, 12 oz / 350 g	9	4	1.3	12	\$ 6.99
MW-SC16	SYNRAY – Cut End – Narrow Band– 16 oz / 450 g / SYNRAY, à brins coupés, bande étroite, 16 oz / 450 g	13	6	1.3	12	\$ 8.49
MW-SC20	SYNRAY – Cut End – Narrow Band– 20 oz / 550 g / SYNRAY, à brins coupés, bande étroite, 20 oz / 550 g	15	7	1.6	12	\$ 10.05
MW-SC24	SYNRAY – Cut End – Narrow Band– 24 oz / 650 g / SYNRAY, à brins coupés, bande étroite, 24 oz / 650 g	18	8	1.6	12	\$ 11.41
MW-SC28	SYNRAY – Cut End – Narrow Band– 28 oz / 750 g / SYNRAY, à brins coupés, bande étroite, 28 oz / 750 g	20	9	1.7	12	\$ 13.37
MW-SC32	SYNRAY – Cut End – Narrow Band– 32 oz / 850 g / SYNRAY, à brins coupés, bande étroite, 32 oz / 850 g	24	11	2.2	12	\$ 14.88
SYNRAY – CUT END – WIDE BAND – WITHOUT BAG / SYNRAY, À BRINS COUPÉS, BANDE LARGE, SANS SAC						
MW-SC16WB	SYNRAY – Cut End – Wide Band – 16 oz / 450 g / SYNRAY, à brins coupés, bande large, 16 oz / 450 g	13	6	1.3	12	\$ 9.82
MW-SC20WB	SYNRAY – Cut End – Wide Band – 20 oz / 550 g / SYNRAY, à brins coupés, bande large, 20 oz / 550 g	15	7	1.6	12	\$ 11.59
MW-SC24WB	SYNRAY – Cut End – Wide Band – 24 oz / 650 g / SYNRAY, à brins coupés, bande large, 24 oz / 650 g	18	8	1.6	12	\$ 13.39
MW-SC32WB	SYNRAY – Cut End – Wide Band – 32 oz / 850 g / SYNRAY, à brins coupés, bande large, 32 oz / 850 g	24	11	2.2	12	\$ 17.61



SYNRAY™ CUT END WET MOPS / VADROUILLES SYNRAY™D HUMIDES À BRINS COUPÉS



SYNRAY - CUT END / BRINS COUPÉS										
	1	2	3	4	5	6	7	8	9	10
Durability / Durabilité										
Absorbency / Absorption										
Release / Capacité D'Évacuation										
Launderability / Blanchiment										
Performance / Performance										

M2 Code Code M2	Description	Pack Wt LB (S) Poids (lb) (S)	Pack Wt KG Poids (kg)	Cubic Ft Pi3	Pack Contenu	List Price Liste des prix
SYNRAY – CUT END – NARROW BAND – BAGGED / SYNRAY, À BRINS COUPÉS, BANDE ÉTROITE, ENSACHÉ						
MW-SC12B	SYNRAY – Cut End – Narrow Band – 12 oz / 350 g / SYNRAY, à brins coupés, bande étroite, 12 oz / 350 g	9	4	1	12	\$ 7.32
MW-SC16B	SYNRAY – Cut End – Narrow Band – 16 oz / 450 g / SYNRAY, à brins coupés, bande étroite, 16 oz / 450 g	13	6	1.3	12	\$ 8.82
MW-SC20B	SYNRAY – Cut End – Narrow Band – 20 oz / 550 g / SYNRAY, à brins coupés, bande étroite, 20 oz / 550 g	15	7	1.6	12	\$ 10.38
MW-SC24B	SYNRAY – Cut End – Narrow Band – 24 oz / 650 g / SYNRAY, à brins coupés, bande étroite, 24 oz / 650 g	18	8	1.6	12	\$ 11.74
MW-SC28B	SYNRAY – Cut End – Narrow Band – 28 oz / 750 g / SYNRAY, à brins coupés, bande étroite, 28 oz / 750 g	20	9	1.7	12	\$ 13.69
MW-SC32B	SYNRAY – Cut End – Narrow Band – 32 oz / 850 g / SYNRAY, à brins coupés, bande étroite, 32 oz / 850 g	24	11	2.2	12	\$ 15.21
SYNRAY – CUT END – WIDE BAND – BAGGED / SYNRAY, À BRINS COUPÉS, BANDE LARGE, ENSACHÉ						
MW-SC12WBB	SYNRAY – Cut End – Wide Band – 12 oz / 350 g / SYNRAY, à brins coupés, bande large, 12 oz / 350 g	9	4	1.3	12	\$ 9.15
MW-SC16WBB	SYNRAY – Cut End – Wide Band – 16 oz / 450 g / SYNRAY, à brins coupés, bande large, 16 oz / 450 g	13	6	1.3	12	\$ 10.12
MW-SC20WBB	SYNRAY – Cut End – Wide Band – 20 oz / 550 g / SYNRAY, à brins coupés, bande large, 20 oz / 550 g	15	7	1.6	12	\$ 11.91
MW-SC24WBB	SYNRAY – Cut End – Wide Band – 24 oz / 650 g / SYNRAY, à brins coupés, bande large, 24 oz / 650 g	18	8	1.6	12	\$ 13.73
MW-SC28WBB	SYNRAY – Cut End – Wide Band – 28 oz / 750 g / SYNRAY, à brins coupés, bande large, 28 oz / 750 g	20	9	2.2	12	\$ 15.42
MW-SC32WBB	SYNRAY – Cut End – Wide Band – 32 oz / 850 g / SYNRAY, à brins coupés, bande large, 32 oz / 850 g	24	11	2.2	12	\$ 17.98

SYNRAY™ CHEATERS - CUT END WET MOPS / VADROUILLES SYNRAY™D CHEATERS - HUMIDES À BRINS COUPÉS



SYNRAY - CUT END / BRINS COUPÉS										
	1	2	3	4	5	6	7	8	9	10
Durability / Durabilité										
Absorbency / Absorption										
Release / Capacité D'Évacuation										
Launderability / Blanchiment										
Performance / Performance										

M2 Code Code M2	Description	Pack Wt LB (S) Poids (lb) (S)	Pack Wt KG Poids (kg)	Cubic Ft Pi3	Pack Contenu	List Price Liste des prix
SYNRAY CHEATERS – CUT END – NARROW BAND – BAGGED / SYNRAY, À BRINS COUPÉS, BANDE ÉTROITE, ENSACHÉ						
MW-SC16B#	SYNRAY – Cut End – Narrow Band – #16 / SYNRAY, à brins coupés, bande étroite, 16#	13	6	1.3	12	\$ 7.32
MW-SC20B#	SYNRAY – Cut End – Narrow Band – 20# / SYNRAY, à brins coupés, bande étroite, 20#	15	7	1.6	12	\$ 8.82
MW-SC24B#	SYNRAY – Cut End – Narrow Band – 24# / SYNRAY, à brins coupés, bande étroite, 24#	18	8	1.6	12	\$ 10.38
MW-SC32B#	SYNRAY – Cut End – Narrow Band – 32# / SYNRAY, à brins coupés, bande étroite, 32#	24	11	2.2	12	\$ 11.74
SYNRAY CHEATERS – CUT END – WIDE BAND – BAGGED / SYNRAY, À BRINS COUPÉS, BANDE LARGE, ENSACHÉ						
MW-SC16WBB#	SYNRAY – Cut End – Wide Band – 16# / SYNRAY, à brins coupés, bande large, 16#	13	6	1.3	12	\$ 9.15
MW-SC20WBB#	SYNRAY – Cut End – Wide Band – 20# / SYNRAY, à brins coupés, bande large, 20#	15	7	1.6	12	\$ 10.12
MW-SC24WBB#	SYNRAY – Cut End – Wide Band – 24# / SYNRAY, à brins coupés, bande large, 24#	18	8	1.6	12	\$ 11.91
MW-SC32WBB#	SYNRAY – Cut End – Wide Band – 32# / SYNRAY, à brins coupés, bande large, 32#	24	11	2.2	12	\$ 13.73

SYNRAY – FANTAIL – NARROW BAND – BAGGED / SYNRAY, ÉVENTAIL, BANDE ÉTROITE, ENSACHÉ



SYNRAY - FANTAIL / ÉVENTAIL										
	1	2	3	4	5	6	7	8	9	10
Durability / Durabilité										
Absorbency / Absorption										
Release / Capacité D'Évacuation										
Launderability / Blanchiment										
Performance / Performance										

*Launderable but not highly recommended

M2 Code Code M2	Description	Pack Wt LB (S) Poids (lb) (S)	Pack Wt KG Poids (kg)	Cubic Ft Pi3	Pack Contenu	List Price Liste des prix
SYNRAY – FANTAIL – NARROW BAND – BAGGED / SYNRAY, ÉVENTAIL, BANDE ÉTROITE, ENSACHÉ						
MW-SC12FTB	SYNRAY Fantail – Narrow Band – 12 oz / 350 g / SYNRAY, éventail, bande étroite, 12 oz / 350 g	9	4	1	12	\$ 9.56
MW-SC16FTB	SYNRAY Fantail – Narrow Band – 16 oz / 450 g / SYNRAY, éventail, bande étroite, 16 oz / 450 g	13	6	1.3	12	\$ 9.91
MW-SC20FTB	SYNRAY Fantail – Narrow Band – 20 oz / 550 g / SYNRAY, éventail, bande étroite, 20 oz / 550 g	15	7	1.6	12	\$ 11.61
MW-SC24FTB	SYNRAY Fantail – Narrow Band – 24 oz / 650 g / SYNRAY, éventail, bande étroite, 24 oz / 650 g	18	8	1.6	12	\$ 13.30
MW-SC32FTB	SYNRAY Fantail – Narrow Band – 32 oz / 850 g / SYNRAY, éventail, bande étroite, 32 oz / 850 g	24	11	2.2	12	\$ 16.59

SYNRAY – LOOPED – NARROW BAND – BAGGED / SYNRAY, À FRANGES BOUCLÉES, BANDE ÉTROITE, ENSACHÉ



SYNRAY - LOOPED / FRANGES BOUCLÉES										
	1	2	3	4	5	6	7	8	9	10
Durability / Durabilité										
Absorbency / Absorption										
Release / Capacité D'Évacuation										
Launderability / Blanchiment										
Performance / Performance										

M2 Code Code M2	Description	Pack Wt LB (S) Poids (lb) (S)	Pack Wt KG Poids (kg)	Cubic Ft Pi3	Pack Contenu	List Price Liste des prix
SYNRAY – LOOPED – NARROW BAND – BAGGED / SYNRAY, À FRANGES BOUCLÉES, BANDE ÉTROITE, ENSACHÉ						
MW-SL15-NB	SYNRAY – Looped – Narrow Band – Small – Bagged / SYNRAY, à franges bouclées, bande étroite, petite, ensaché	13	6	1.3	12	\$ 9.40
MW-SL2M-NB	SYNRAY – Looped – Narrow Band – Medium – Bagged / SYNRAY, à franges bouclées, bande étroite, moyenne, ensaché	15	7	1.6	12	\$ 11.00
MW-SL3L-NB	SYNRAY – Looped – Narrow Band – Large – Bagged / SYNRAY, à franges bouclées, bande étroite, grande, ensaché	18	8	1.6	12	\$ 12.65
MW-SL4XL-NB	SYNRAY – Looped – Narrow Band – X-Large – Bagged / SYNRAY, à franges bouclées, bande étroite, très grande, ensaché	24	11	2.2	12	\$ 18.85
SYNRAY – LOOPED – WIDE BAND – BAGGED / SYNRAY, À FRANGES BOUCLÉES, BANDE LARGE, ENSACHÉ						
MW-SL10S-WB	SYNRAY – Looped – Wide Band – Small – Bagged / SYNRAY, à franges bouclées, bande large, petite, ensaché	13	6	1.3	12	\$ 11.10
MW-SL11M-WB	SYNRAY – Looped – Wide Band – Medium – Bagged / SYNRAY, à franges bouclées, bande large, moyenne, ensaché	15	7	1.6	12	\$ 12.99
MW-SL12L-WB	SYNRAY – Looped – Wide Band – Large – Bagged / SYNRAY, à franges bouclées, bande large, grande, ensaché	18	8	1.6	12	\$ 14.98
MW-SL13XL-WB	SYNRAY – Looped – Wide Band – X-Large – Bagged / SYNRAY, à franges bouclées, bande large, très grande, ensaché	24	11	2.2	12	\$ 21.91



COTTON-PRO™

CUT END & LOOPED WET MOPS

VADROUILLES HUMIDES À BRINS COUPÉS ET À FRANGES BOUCLÉES

COTTON PRO - CUT END / BRINS COUPÉS										
	1	2	3	4	5	6	7	8	9	10
Durability/ Durabilité										
Absorbency/ Absorption										
Release/ Capacité D'Évacuation										
Launderability/ Blanchiment										
Performance/ Performance										

M2 uses a superior grade of 4 ply cotton yarn which requires less break-in. Our cotton mops can ideally be used for all purpose washing, scrubbing and stripping.

M2 se sert d'un tissu en coton, quatre fils, haut de gamme, qui requiert moins de préparation avant l'utilisation.

Nos vadrouilles en coton conviennent parfaitement au lavage, au récurage et au décapage généraux.

HEADBAND COLOURS ON COTTON MOPS / COULEURS DE LA BANDE DE TÊTE DE LA VADROUILLE EN COTON



M2 Code Code M2	Description	Pack Wt LB (S) Poids (lb) (S)	Pack Wt KG Poids (kg)	Cubic Ft Pi3	Pack Contenu	List Price Liste des prix
COTTON – CUT END – NARROW BAND – NO BAG / COTON, À BRINS COUPÉS, BANDE ÉTROITE, SANS SAC						
MW-CC12	Cotton – Cut End – Narrow Band– 12 oz / 350 g / Coton, à brins coupés, bande étroite, 12 oz / 350 g	9	4	1	12	\$ 5.44
MW-CC16	Cotton – Cut End – Narrow Band– 16 oz / 450 g / Coton, à brins coupés, bande étroite, 16 oz / 450 g	13	6	1	12	\$ 6.65
MW-CC20	Cotton – Cut End – Narrow Band– 20 oz / 550 g / Coton, à brins coupés, bande étroite, 20 oz / 550 g	15	7	1.5	12	\$ 7.86
MW-CC24	Cotton – Cut End – Narrow Band– 24 oz / 650 g / Coton, à brins coupés, bande étroite, 24 oz / 650 g	18	8	1.5	12	\$ 9.02
MW-CC32	Cotton – Cut End – Narrow Band– 32 oz / 850 g / Coton, à brins coupés, bande étroite, 32 oz / 850 g	24	11	2	12	\$ 12.02
COTTON – CUT END – WIDE BAND – NO BAG / COTON, À BRINS COUPÉS, BANDE LARGE, SANS SAC						
MW-CC12WB	Cotton – Cut End – Wide Band– 12 oz / 350 g / Coton, à brins coupés, bande large, 12 oz / 350 g	13	6	1	12	\$ 7.09
MW-CC16WB	Cotton – Cut End – Wide Band– 16 oz / 450 g / Coton, à brins coupés, bande large, 16 oz / 450 g	13	6	1	12	\$ 8.30
MW-CC20WB	Cotton – Cut End – Wide Band– 20 oz / 550 g / Coton, à brins coupés, bande large, 20 oz / 550 g	15	7	1.5	12	\$ 9.81
MW-CC24WB	Cotton – Cut End – Wide Band– 24 oz / 650 g / Coton, à brins coupés, bande large, 24 oz / 650 g	18	8	1.5	12	\$ 11.31
MW-CC32WB	Cotton – Cut End – Wide Band– 32 oz / 850 g / Coton, à brins coupés, bande large, 32 oz / 850 g	24	11	2	12	\$ 14.93

COTTON – CUT END – NARROW BAND – BAGGED / COTON, À BRINS COUPÉS, BANDE ÉTROITE, ENSACHÉ



COTTON PRO - CUT END / BRINS COUPÉS										
	1	2	3	4	5	6	7	8	9	10
Durability / Durabilité										
Absorbency / Absorption										
Release / Capacité D'Évacuation										
Launderability / Blanchiment										
Performance / Performance										

COTTON PRO - FANTAIL / ÉVENTAIL										
	1	2	3	4	5	6	7	8	9	10
Durability / Durabilité										
Absorbency / Absorption										
Release / Capacité D'Évacuation										
Launderability / Blanchiment										
Performance / Performance										

*Launderable but not highly recommended

M2 Code Code M2	Description	Pack Wt LB (S) Poids (lb) (S)	Pack Wt KG Poids (kg)	Cubic Ft Pi3	Pack Contenu	List Price Liste des prix
COTTON – CUT END – NARROW BAND – BAGGED / COTON, À BRINS COUPÉS, BANDE ÉTROITE, ENSACHÉ						
MW-CC12B	Cotton – Cut End – Narrow Band – 12 oz / 350 g - Bagged / Coton, bande étroite, 12 oz / 350 g - ensaché	9	4	1	12	\$ 6.43
MW-CC16B	Cotton – Cut End – Narrow Band – 16 oz / 450 g - Bagged / Coton, bande étroite, 16 oz / 450 g - ensaché	13	6	1	12	\$ 7.76
MW-CC20B	Cotton – Cut End – Narrow Band – 20 oz / 550 g - Bagged / Coton, bande étroite, 20 oz / 550 g - ensaché	15	7	1.5	12	\$ 9.13
MW-CC24B	Cotton – Cut End – Narrow Band – 24 oz / 650 g - Bagged / Coton, bande étroite, 24 oz / 650 g - ensaché	18	8	1.5	12	\$ 10.43
MW-CC32B	Cotton – Cut End – Narrow Band – 32 oz / 850 g - Bagged / Coton, bande étroite, 32 oz / 850 g - ensaché	24	11	2	12	\$ 13.80
COTTON – CUT END – WIDE BAND – BAGGED / COTON, À BRINS COUPÉS, BANDE LARGE, ENSACHÉ						
MW-CC12WBB	Cotton – Cut End – Wide Band – 12 oz / 350 g - Bagged / Coton, à brins coupés, bande large, 12 oz / 350 g - ensaché	13	6	1	12	\$ 8.29
MW-CC16WBB	Cotton – Cut End – Wide Band – 16 oz / 450 g - Bagged / Coton, à brins coupés, bande large, 16 oz / 450 g - ensaché	13	6	1	12	\$ 9.64
MW-CC20WBB	Cotton – Cut End – Wide Band – 20 oz / 550 g - Bagged / Coton, à brins coupés, bande large, 20 oz / 550 g - ensaché	15	7	1.5	12	\$ 11.34
MW-CC24WBB	Cotton – Cut End – Wide Band – 24 oz / 650 g - Bagged / Coton, à brins coupés, bande large, 24 oz / 650 g - ensaché	18	8	1.5	12	\$ 13.02
MW-CC32WBB	Cotton – Cut End – Wide Band – 32 oz / 850 g - Bagged / Coton, à brins coupés, bande large, 32 oz / 850 g - ensaché	24	11	2	12	\$ 17.08
COTTON – FANTAIL – NARROW BAND – BAGGED / COTON, ÉVENTAIL, BANDE ÉTROITE, ENSACHÉ						
MW-CC16FTB	Cotton – Fantail – NB – 16 oz / 450 g - Bagged / Coton, à franges bouclées, bande étroite, 16 oz / 450 g - ensaché	13	6	1	12	\$ 9.00
MW-CC20FTB	Cotton – Fantail – NB – 20 oz / 550 g - Bagged / Coton, à franges bouclées, bande étroite, 20 oz / 550 g - ensaché	15	7	1.5	12	\$ 10.76
MW-CC24FTB	Cotton – Fantail – NB – 24 oz / 650 g - Bagged / Coton, à franges bouclées, bande étroite, 24 oz / 650 g - ensaché	18	8	1.5	12	\$ 12.39
MW-CC32FTB	Cotton – Fantail – NB – 32 oz / 850 g - Bagged / Coton, à franges bouclées, bande étroite, très 32 oz / 850 g - ensaché	24	11	2	12	\$ 15.75

COTTON – LOOPED – NARROW BAND – BAGGED / COTON, À FRANGES BOUCLÉES, BANDE ÉTROITE, ENSACHÉ



COTTON PRO - LOOPED / FRANGES BOUCLÉES										
	1	2	3	4	5	6	7	8	9	10
Durability / Durabilité										
Absorbency / Absorption										
Release / Capacité D'Évacuation										
Launderability / Blanchiment										
Performance / Performance										

M2 Code Code M2	Description	Pack Wt LB (S) Poids (lb) (S)	Pack Wt KG Poids (kg)	Cubic Ft Pi3	Pack Contenu	List Price Liste des prix
COTTON – LOOPED – NARROW BAND – BAGGED / COTON, À FRANGES BOUCLÉES, BANDE ÉTROITE, ENSACHÉ						
MW-CL15-NB	Cotton – Looped – Narrow Band – Small – Bagged / Coton, à franges bouclées, bande étroite, petite, ensaché	13	6	1.3	12	\$ 89.78
MW-CL2M-NB	Cotton – Looped – Narrow Band – Medium – Bagged / Coton, à franges bouclées, bande étroite, moyenne, ensaché	15	6.8	1.6	12	\$ 12.08
MW-CL3L-NB	Cotton – Looped – Narrow Band – Large – Bagged / Coton, à franges bouclées, bande étroite, grande, ensaché	18	8	1.6	12	\$ 13.91
MW-CL4XL-NB	Cotton – Looped – Narrow Band – X-Large – Bagged / Coton, à franges bouclées, bande étroite, très grande, ensaché	24	10.8	2	12	\$ 17.04
COTTON – LOOPED – WIDE BAND – BAGGED / COTON, À FRANGES BOUCLÉES, BANDE LARGE, ENSACHÉ						
MW-CL10S-WB	Cotton – Looped – Wide Band – Small – Bagged / Coton, à franges bouclées, bande large, petite, ensaché	13	6	1.3	12	\$ 11.63
MW-CL11M-WB	Cotton – Looped – Wide Band – Medium – Bagged / Coton, à franges bouclées, bande large, moyenne, ensaché	15	6.8	1.6	12	\$ 14.28
MW-CL12L-WB	Cotton – Looped – Wide Band – Large – Bagged / Coton, à franges bouclées, bande large, grande, ensaché	18	8	1.6	12	\$ 16.48
MW-CL13XL-WB	Cotton – Looped – Wide Band – X-Large – Bagged / Coton, à franges bouclées, bande large, très grande, ensaché	24	10.8	2.2	12	\$ 20.41



COTTON PRO™ CHEATERS - CUT END WET MOPS / VADROUILLES COTTON PRO™ CHEATERS - HUMIDES À BRINS COUPTÉS



COTTON PRO - CUT END / BRINS COUPTÉS										
	1	2	3	4	5	6	7	8	9	10
Durability / Durabilité										
Absorbency / Absorption										
Release / Capacité D'Évacuation										
Launderability / Blanchiment										
Performance / Performance										

M2 Code Code M2	Description	Pack Wt LB (S) Poids (lb) (S)	Pack Wt KG Poids (kg)	Cubic Ft Pi3	Pack Contenu	List Price Liste des prix
COTTON PRO – CUT END – NARROW BAND – NO BAG/ COTON PRO, À BRINS COUPTÉS, BANDE ÉTROITE, ENSACHÉ						
MW-CC16#	Cotton – Cut End – Narrow Band – 16# - No Bag / Coton, bande étroite, bande étroite, 16# - Ensaché	13	6	1	12	\$ 6.09
MW-CC20#	Cotton – Cut End – Narrow Band– 20# - No Bag/ Coton, bande étroite, bande étroite, 20# - Ensaché	15	7	1.5	12	\$ 7.46
MW-CC24#	Cotton – Cut End – Narrow Band– 24# - No Bag/ Coton, bande étroite, bande étroite, 24# - Ensaché	18	8	1.5	12	\$ 8.82
MW-CC32#	Cotton – Cut End – Narrow Band– 32# - No Bag / Coton, à brins coupés, bande étroite, 32# - Ensaché	24	11	2	12	\$ 10.14
COTTON PRO – CUT END – NARROW BAND – BAGGED / COTON PRO, À BRINS COUPTÉS, BANDE ÉTRUITE, ENSACHÉ						
MW-CC16B#	Cotton – Cut End – Narrow Band – 16# - Bagged/ Coton, bande étroite, bande étroite, 16# - Ensaché	13	6	1	12	\$ 6.43
MW-CC20B#	Cotton – Cut End – Narrow Band– 20# - Bagged/ Coton, bande étroite, bande étroite, 20# - Ensaché	15	7	1.5	12	\$ 7.76
MW-CC24B#	Cotton – Cut End – Narrow Band– 24# - Bagged/ Coton, bande étroite, bande étroite, 24# - Ensaché	18	8	1.5	12	\$ 9.13
MW-CC32B#	Cotton – Cut End – Narrow Band– 32# - Bagged/ Coton, bande étroite, bande étroite, 32# - Ensaché	24	11	2	12	\$ 10.43
COTTON PRO – CUT END – WIDE BAND – BAGGED / COTON PRO, À BRINS COUPTÉS, BANDE LARGE, ENSACHÉ						
MW-CC16WBB#	Cotton – Cut End – Wide Band – 16# - Bagged/ Coton, à brins coupés, bande large, 16# - Ensaché	13	6	1	12	\$ 8.29
MW-CC20WBB#	Cotton – Cut End – Wide Band – 20 # - Bagged/ Coton, à brins coupés, bande large, 20# - Ensaché	15	7	1.5	12	\$ 9.64
MW-CC24WBB#	Cotton – Cut End – Wide Band– 24# - Bagged/ Coton, à brins coupés, bande large, 24# - Ensaché	18	8	1.5	12	\$ 11.34
MW-CC32WBB#	Cotton – Cut End – Wide Band– 32# - Bagged/ Coton, à brins coupés, bande large, 32# - Ensaché	24	11	2	12	\$ 13.02

VALUE ECONOMY MOPS / VADROUILLES ÉCONOMIQUES



VALUE ECONOMY - LOOPED / FRANGES BOUCLÉES										
	1	2	3	4	5	6	7	8	9	10
Durability / Durabilité										
Absorbency / Absorption										
Release / Capacité D'Évacuation										
Launderability / Blanchiment										
Performance / Performance										

VALUE ECONOMY - CUT END / BRINS COUPTÉS										
	1	2	3	4	5	6	7	8	9	10
Durability / Durabilité										
Absorbency / Absorption										
Release / Capacité D'Évacuation										
Launderability / Blanchiment										
Performance / Performance										

* Launderable but not highly recommended
* Lavable mais pas fortement recommandé

M2 Code Code M2	Description	Pack Wt LB (S) Poids (lb) (S)	Pack Wt KG Poids (kg)	Cubic Ft Pi3	Pack Contenu	List Price Liste des prix
VALUE ECONOMY CUT END - NARROW BAND - BAGGED / VADROUILLE QUALITÉ ÉCONOMIQUE - BOUT COUPÉ - BANDE ÉTROITE - bleuE - ENSACHÉE						
MW-VEC16B-BL	Value Economy – Cut End – NB – 16 oz / 450 g - Bagged - Blue / Vadrouille de qualité économique bout coupé - Bande étroite - bleue - Ensachée 16 oz / 450 g	13	6	1	12	\$ 9.05
MW-VEC20B-BL	Value Economy – Cut End – NB – 20 oz / 550 g - Bagged - Blue / Vadrouille de qualité économique bout coupé - Bande étroite - bleue - Ensachée 20 oz / 550 g	15	7	1.5	12	\$ 10.56
MW-VEC24B-BL	Value Economy – Cut End – NB – 24 oz / 650 g - Bagged - Blue / Vadrouille de qualité économique bout coupé - Bande étroite - bleue - Ensachée 24 oz / 650 g	18	8	1.5	12	\$ 12.07
MW-VEC32B-BL	Value Economy – Cut End – NB – 32 oz / 850 g - Bagged - Blue / Vadrouille de qualité économique bout coupé - Bande étroite - bleue - Ensachée 32 oz / 850 g	24	11	2	12	\$ 16.61
VALUE ECONOMY LOOPED END - NARROW BAND - BLUE / VADROUILLE QUALITÉ ÉCONOMIQUE - POIDS RÉEL - EXTRÉMITÉS BOUCLÉS BANDE ÉTROITE						
MW-VEL16-NB-BL	Value Economy – Looped End – NB – 16 oz / 450 g - Blue / Vadrouille qualité économique - Poids réel - Extrémités bouclés - bleue - Ensachée 16 oz / 450 g	15	6.8	1.6	12	\$ 9.69
MW-VEL20-NB-BL	Value Economy – Looped End – NB – 20 oz / 550 g - Blue / Vadrouille qualité économique - Poids réel - Extrémités bouclés - bleue - Ensachée 20 oz / 550 g	18	8	1.6	12	\$ 11.07
MW-VEL24-NB-BL	Value Economy – Looped End – NB – 24 oz / 650 g - Bagged - Blue / Vadrouille qualité économique - Poids réel - Extrémités bouclés - bleue - 24 oz / 650 g	24	10.8	2.2	12	\$ 12.46

VALUE ECONOMY R-BLEND MOPS /

- Ideal for Foodservice
- Low usage

- Idéal pour les services alimentaires
- Travaux légers



HEADBAND COLOURS ON ECONOMY MOPS / COULEURS DE BANDE SUR LES VADROUILLES ÉCONOMIQUES



M2 Code Code M2	Description	Pack Wt LB (S) Poids (lb) (S)	Pack Wt KG Poids (kg)	Cubic Ft Pi3	Pack Contenu	List Price Liste des prix
VALUE ECONOMY COTTON CUT END - NARROW BAND / - VADROUILLE DE COTON QUALITÉ ÉCONOMIQUE - BANDE ÉTROITE - ENSACHÉE						
MW-VCC12B	Value Economy Cotton – Cut End – NB– 12 oz / 350 g - Bagged / Vadrouille de coton qualité économique - Bande étroite - Ensachée 12 oz / 350 g	9	4	1	12	\$ 5.84
MW-VCC16B	Value Economy Cotton – Cut End – NB– 16 oz / 450 g - Bagged / Vadrouille de coton qualité économique - Bande étroite - Ensachée 16 oz / 450 g	13	6	1	12	\$ 7.05
MW-VCC20B	Value Economy Cotton – Cut End – NB– 20 oz / 550 g - Bagged / Vadrouille de coton qualité économique - Bande étroite - Ensachée 20 oz / 550 g	15	7	1.5	12	\$ 8.31
MW-VCC24B	Value Economy Cotton – Cut End – NB– 24 oz / 650 g - Bagged / Vadrouille de coton qualité économique - Bande étroite - Ensachée 24 oz / 650 g	18	8	1.5	12	\$ 9.49
MW-VCC32B	Value Economy Cotton – Cut End – NB– 32 oz / 850 g - Bagged / Vadrouille de coton qualité économique - Bande étroite - Ensachée 32 oz / 850 g	24	11	2	12	\$ 12.55
VALUE ECONO-RAY CUT END - NARROW BAND - BAGGED /						
MW-VEC12B-CA	Econo-Ray – Cut End – NB– 12 oz / 350 g - Bagged / Vadrouille de qualité économique - Bande étroite - Ensachée 2 oz / 350 g	13	6	1	12	\$ 6.78
MW-VEC16B-CA	Econo-Ray – Cut End – NB– 16 oz / 450 g - Bagged / Vadrouille de qualité économique - Bande étroite - Ensachée 16 oz / 450 g	13	6	1	12	\$ 7.05
MW-VEC20B-CA	Econo-Ray – Cut End – NB– 20 oz / 550 g - Bagged / Vadrouille de qualité économique - Bande étroite - Ensachée 20 oz / 550 g	15	7	1.5	12	\$ 8.23
MW-VEC24B-CA	Econo-Ray – Cut End – NB– 24 oz / 650 g - Bagged / Vadrouille de qualité économique - Bande étroite - Ensachée 24 oz / 650 g	18	8	1.5	12	\$ 9.41
MW-VECE32B-CA	Econo-Ray – Cut End – NB– 32 oz / 850 g - Bagged / Vadrouille de qualité économique - Bande étroite - Ensachée 32 oz / 850 g	24	11	2	12	\$ 12.94

LAYFLAT STYLE MOPS /



M2 Code Code M2	Description	Pack Wt LB (S) Poids (lb) (S)	Pack Wt KG Poids (kg)	Cubic Ft Pi3	Pack Contenu	List Price Liste des prix
LAYFLAT STYLE COTTON MOPS NARROW BAND-BAGGED / BANDE ÉTROITE ENSACHÉ						
MW-LFC16B	16oz/450g LayFlat Style Cotton - Bagged / Vadrouille Rayon bouts coupés, bande étroite 16 oz/450 g ensachée/vissée	13	6	1	12	\$11.50
MW-LFC20B	20oz/550g LayFlat Style Cotton - Bagged / Vadrouille Rayon bouts coupés, bande étroite 20 oz/550 g ensachée/vissée	15	7	1.5	12	\$ 12.90
MW-LFC24B	24oz/650g LayFlat Style Cotton - Bagged / Vadrouille Rayon bouts coupés, bande étroite 24 oz/650 g ensachée/vissée	18	8	1.5	12	\$ 14.73
LAYFLAT STYLE RAYON (WHITE)NARROW BAND-BAGGED / BANDE ÉTROITE ENSACHÉ						
MW-LFR16B	16oz/450g LayFlat Style Rayon White - Bagged / Vadrouille Rayon bouts coupés, bande étroite 16 oz/450 g ensachée/vissée - blanc	13	6	1	12	\$ 12.99
MW-LFR20B	20oz/550g LayFlat Style Rayon White - Bagged / Vadrouille Rayon bouts coupés, bande étroite 20 oz/550 g ensachée/vissée - blanc	15	7	1.5	12	\$ 15.01
MW-LFR24B	24oz/650g LayFlat Style Rayon White - Bagged / Vadrouille Rayon bouts coupés, bande étroite 24 oz/650 g ensachée/vissée - blanc	18	8	1.5	12	\$ 16.98



LAYFLAT STYLE MOPS /



M2 Code Code M2	Description	Pack Wt LB (S) Poids (lb) (S)	Pack Wt KG Poids (kg)	Cubic Ft Pi3	Pack Contenu	List Price Liste des prix
LAYFLAT STYLE COTTON MOPS NARROW BAND-BAGGED / BANDE ÉTROITE ENSACHÉ						
MW-LFB16BB	16oz/450g LayFlat Style BlueBlend - Bagged / Vadrouille Rayon bouts coupés, bande étroite 16 oz/650 g ensachée/vissée - bleu	13	6	1	12	\$12.36
MW-LFB20BB	20oz/550g LayFlat Style BlueBlend - Bagged / Vadrouille Rayon bouts coupés, bande étroite 20 oz/550 g ensachée/vissée - bleu	15	7	1.5	12	\$14.55
MW-LFB24BB	24oz/650g LayFlat Style BlueBlend - Bagged / Vadrouille Rayon bouts coupés, bande étroite 24 oz/650 g ensachée/vissée - bleu	18	8	1.5	12	\$16.62

CANDYSTRIP WAXER™ LOOPED END MOP / CANDYSTRIP WAXER™ À FRANGES BOUCLÉES



CANDYSTRIP WAXER - LOOPED / FRANGES BOUCLÉES										
	1	2	3	4	5	6	7	8	9	10
Durability / Durabilité										
Absorbency / Absorption										
Release / Capacité D'Évacuation										
Launderability / Blanchiment										
Performance / Performance										



HARDSTRING FINISHER NB CUT END / HARDSTRING FINISSEUR BANDE ÉTROITE BOUT COUPÉ

HARDSTRING - CUT END / BRINS COUPÉS										
	1	2	3	4	5	6	7	8	9	10
Durability / Durabilité										
Absorbency / Absorption										
Release / Capacité D'Évacuation										
Launderability / Blanchiment										
Performance / Performance										

M2 Code Code M2	Description	Pack Wt LB (S) Poids (lb) (S)	Pack Wt KG Poids (kg)	Cubic Ft Pi3	Pack Contenu	List Price Liste des prix
MW-CS16	CandyStripe Waxer floor mop - Narrow Band - Looped End - Small / CandyStripe Waxer vadrouille - à franges bouclées-Bande étroite - Petit	13	6	1.3	12	\$14.42
MW-CS20	CandyStripe Waxer floor mop - Narrow Band - Looped End Medium / CandyStripe Waxer vadrouille - à franges bouclées-Bande étroite - Moyen	15	7	1.6	12	\$16.72
MW-CS24	CandyStripe Waxer floor mop - Narrow Band - Looped End Large / CandyStripe Waxer vadrouille - à franges bouclées-Bande étroite - Grand	15	7	1.6	12	\$19.39
MW-HS16B	HardString Finisher - Narrow Band - 16 oz / 450 g Bagged / HardString Finisseur - Bande étroite-16 oz / 450 g avec sac	13	6	1.3	12	\$16.67
MW-HS20B	HardString Finisher - Narrow Band - 20 oz / 550 g Bagged / HardString Finisseur - Bande étroite-16 oz / 550 g avec sac	15	7	1.6	12	\$19.60
MW-HS24B	HardString Finisher - Narrow Band - 24 oz / 650 g Bagged / HardString Finisseur - Bande étroite-16 oz / 650 g avec sac	15	7	1.6	12	\$22.60

GLACIER NYLON FLOOR & WAXING MOP / VADROUILLES POUR LAVAGE ET CIRAGE DE PLANCHER GLACIER

- Easily slides across floor reducing worker fatigue
- Recommended for buffing high gloss surfaces
- Less waste at end of task
- Glisse facilement sur le sol en réduisant la fatigue du travailleur
- Recommandé pour usage sur des surfaces polies
- Moins de déchets à la fin de la tâche



For use with Dust Clipper Frame / À utiliser avec le Cadre "Clipper"

GLACIER - LOOPED / FRANGES BOUCLÉES										
	1	2	3	4	5	6	7	8	9	10
Durability / Durabilité										
Absorbency / Absorption										
Release / Capacité D'Évacuation										
Launderability / Blanchiment										
Performance / Performance										

M2 Code Code M2	Description	Pack Wt LB (S) Poids (lb) (S)	Pack Wt KG Poids (kg)	Cubic Ft Pi3	Pack Contenu	List Price Liste des prix
MW-W16	Glacier White Waxer - Nylon Floor Mop - NB- 16 oz / Lave-sol, blanc glacier nylon à bande étroite sans peluche, 16 oz	13	6	1.3	12	\$22.95
MW-W20	Glacier White Waxer - Nylon Floor Mop - NB- 20 oz / Lave-sol, blanc glacier nylon à bande étroite sans peluche, 20 oz	15	7	1.6	12	\$25.69
MW-W24	Glacier White Waxer - Nylon Floor Mop - NB- 24 oz / Lave-sol, blanc glacier nylon à bande étroite sans peluche, 24 oz	15	7	1.6	12	\$30.70
MW-W32	Glacier White Waxer - Nylon Floor Mop - NB- 32 oz / Lave-sol, blanc glacier nylon à bande étroite sans peluche, 32 oz	16	7.5	2	12	\$40.55
GLACIER NYLON FINISHING MOP / VADROUILLES À POUSSIÈRE EN NYLON "GLACIER"						
DM-W518	Glacier Nylon Finishing Mops - 5" x 18" / 13 x 46 cm - Tie-on / Vadrouilles à poussière en nylon "Glacier", 5 x 18"/46 cm x 13 cm - Attacher	9.5	4.3		12	\$40.46
DM-WV518	Glacier Nylon Velcro MopPad - 5" x 18" / 13 x 46 cm / Vadrouilles à poussière en nylon avec Velcro "Glacier", 5 x 18"/46 cm x 13 cm	9.5	4.3		12	\$23.62

SUPERSORB MADE FROM 100% RE-PURPOSED POST-INDUSTRIAL NON-WOVEN MATERIALS / FABRIQUÉ À PARTIR DE MATÉRIEAUX NON TISSÉS 100% RECYCLÉ APRÈS INDUSTRIALISATION.



**ABSORBE
7 FOIS
SON POIDS**

SUPERSORB- LOOPED / FRANGES BOUCLÉES										
	1	2	3	4	5	6	7	8	9	10
Durability / Durabilité										
Absorbency / Absorption										
Release / Capacité D'Évacuation										
Launderability / Blanchiment										
Performance / Performance										

* Not recommended for laundering /
* Non recommandé pour le blanchissage

- Most suitable in areas where a large absorption of liquid is required
- Ideal for oil and solvents
- Can also be used on rough surface floors

- Le plus approprié dans les zones où une grande absorption du liquide est exigée
- Grandiose pour ramasser les déversements
- Idéal pour les huiles et solvants

M2 Code	Description	Pack Wt LB (S)	Pack Wt KG	Cubic Ft	Pack	List Price
Code M2		Poids (lb) (S)	Poids (kg)	Pi3	Contenu	Liste des prix
MW-SS11920	SuperSorb Spill Mop - Medium / Vadrouille moyenne pour surface rugueuse - Moyen				12	\$ 12.38
MW-SS11924	SuperSorb Spill Mop - Large / Vadrouille moyenne pour surface rugueuse - Grand				12	\$ 14.03

ROUGH SURFACE MOP / VAIDROUILLE MOYENNE POUR SURFACE RUGUEUSE



ROUGH SURFACE MOP / POUR SURFACE RUGUEUSE										
Wet Mop Version										
	1	2	3	4	5	6	7	8	9	10
Durability / Durabilité										
Absorbency / Absorption										
Release / Capacité D'Évacuation										
Launderability / Blanchiment										
Performance / Performance										

MW-RF2090	Rough Surface Mop – Medium - Yellow / Vadrouille moyenne pour surface rugueuse-jaune				6/1	\$ 23.12
YM-Y412	Detachable Ruff Surface Yacht Mop – Cut End – Small - Yellow / Petite vadrouille "Yacht" à bouts coupés, détachable, pour surface rugueuse				12/1	\$ 15.62
YM-Y412-M348	Detachable Ruff Surface Yacht Mop – Cut End – Small - Yellow with 48" metal handle / Petite vadrouille "Yacht" à bouts coupés, détachable, pour surface rugueuse - manche de métal 48"				12/1	\$ 18.82

MAC MOP - IDEAL FOR FOODSERVICE / VAIDROUILLE MAC - IDÉALE POUR SERVICE D'ALIMENTATION



MAC MOP - LOOPED / FRANGES BOUCLÉES										
	1	2	3	4	5	6	7	8	9	10
Durability / Durabilité										
Absorbency / Absorption										
Release / Capacité D'Évacuation										
Launderability / Blanchiment										
Performance / Performance										

MW-BM16	16 oz/450g Mac Mop Looped - NB - Bagged - Orange/Yellow / Mac Mop à brins coupés, 16oz,450g, bande étroite, Ensaché				12	\$ 17.41
MW-BM20	20 oz/550g Mac Mop Looped - NB - Bagged - Orange/Yellow / Mac, à brins coupés, 20oz/550g, bande étroite, Ensaché				12	\$ 19.63
MW-BM24	24 oz/650g Mac Mop Looped - NB - Bagged Orange/Yellow / Mac, à brins coupés, 24oz/650g, bande étroite, Ensaché				12	\$ 22.58

MICROFIBER TUBE LOOPED MOPS / VAIDROUILLE EN MICROFIBER BOUCLÉE



MW-TM396	Medium Microfiber Tube Looped Mop WB - Green				24/12	\$ 31.28
MW-TM600	Large Microfiber Tube Looped Mop WB - Blue				20/10	\$ 47.02



MICROFIBER LOOPED MOP - NARROW BAND



M2 Code Code M2	Description	Pack Wt LB (S) Poids (lb) (S)	Pack Wt KG Poids (kg)	Cubic Ft Pi3	Pack Contenu	List Price Liste des prix
MICROFIBER LOOPED MOP NARROW BAND - BLUE, RED, YELLOW, GREEN						
MW-MM16-BL	16oz/450g MicroFiber Mop - NBand Looped – NB Bagged - Blue,Red,Yellow,Green	13	6	1.3	12	\$ 21.14
MW-MM20-BL	20oz/550g MicroFiber Mop - NBand Looped – NB Bagged - Blue	15	7	1.6	12	\$ 24.07
MW-MM24-BL	24oz/650g MicroFiber Mop - NBand Looped – NB Bagged - Blue	15	7	1.6	12	\$ 27.68
MW-MM32-BL	32oz/850g MicroFiber Mop - NBand Looped – NB Bagged - Blue,Red,Yellow,Green	16	7.5	2	12	\$ 34.84
MW-MM20-RD	20oz/550g MicroFiber Mop NBand Looped mop Bagged-Red	9.5	4.3		12	\$ 24.07
MW-MM24-RD	24oz/650g MicroFiber Mop NBand Looped mop 20oz/550g Bagged-Red	9.5	4.3		12	\$ 27.68

ALL-IN-ONE PROMOP COMBOS / ENSEMBLE TOU-EN-UN PROMOP

PROMOP COMBO SYNRAY - NARROW BAND WITH 60" SNAP-N-GO METAL HANDLE



PROMOP COMBO SWINGER MEDIUM NARROW BAND WITH 60" SNAP-N-GO METAL HANDLE



PROMOP COMBO COTTON - NARROW BAND WITH 60" SNAP-N-GO METAL HANDLE



HW-PC-80016	ProMop Combo – 16 oz / 450 g SynRay Mop – Narrow Band with STEP-N-GO metal 60" Handle / Ensemble ProMop, vadrouille Synray de 16 oz / 450 g, bande étroite, munie d'un manche métallique de 60 po / 152 cm				12	\$ 31.31
HW-PC-80020	ProMop Combo – 20 oz / 550 g SynRay Mop – Narrow Band with STEP-N-GO metal 60" Handle / Ensemble ProMop, vadrouille Synray de 20 oz / 550 g, bande étroite, munie d'un manche métallique de 60 po / 152 cm	1.6	.72	3.5	12	\$ 31.58
HW-PC-80024	ProMop Combo – 24 oz / 650 g SynRay Mop – Narrow Band with STEP-N-GO metal 60" Handle / Ensemble ProMop, vadrouille Synray de 24 oz 650 g, bande étroite, munie d'un manche métallique de 60 po / 152 cm	1.6	.72	3.5	12	\$ 34.39
HW-PC-90020	Promop Combo – Medium Swinger Mop – Looped – Narrow Band with STEP-N-GO metal 60" Handle / Ensemble ProMop, vadrouille à franges bouclées Swinger, bande étroite, munie d'un manche métallique de STEP-N-GO 60 po / 152cm	1.6	.72	3.5	12	\$ 37.89
HW-PC-80016C	ProMop Combo – 16 oz / 450 g Cotton Mop – Narrow Band with STEP-N-GO metal 60" Handle / Ensemble ProMop, vadrouille Coton de 16 oz / 450 g, bande étroite, munie d'un manche métallique de 60 po / 152 cm				12	\$ 29.69
HW-PC-80020C	ProMop Combo – 20 oz / 550 g Cotton Mop – Narrow Band with STEP-N-GO metal 60" Handle / Ensemble ProMop, vadrouille Coton de 20 oz / 550 g, bande étroite, munie d'un manche métallique de 60 po / 152 cm	1.6	.72	3.5	12	\$ 31.01
HW-PC-80024C	ProMop Combo – 24 oz / 650 g Cotton Mop – Narrow Band with STEP-N-GO metal 60" Handle / Ensemble ProMop, vadrouille Coton de 24 oz 650 g, bande étroite, munie d'un manche métallique de 60 po / 152 cm	1.6	.72	3.5	12	\$ 33.42

WET MOP ACCESSORIES



EFM-PS-10121	Laundry Net , White / Filet à buanderie, blanc				1	\$ 25.44
SC-7490	Scrubby Foot Pad -Scuff and Shoe Mark Remover -Fits on Mop Handle - Blue / Tampon à pied pour récurer les éraflures et les marques de soulier - s'adapte au manche de vadrouille - bleu				10/Bag	\$ 13.67

DETACHABLE MOPS / VADROUILLES DÉTACHABLES

BLUE & WHITE STRIP MOP / VADROUILLE EN BANDES BLEUE ET BLANCHE



MICROFIBER STRIP MOP - LOOPED / FRANGES BOUCLÉES										
	1	2	3	4	5	6	7	8	9	10
Durability / Durabilité										
Absorbency / Absorption										
Release / Capacité D'Évacuation										
Launderability / Blanchiment										
Performance / Performance										

M2 Code Code M2	Description	Pack Wt LB (S) Poids (lb) (S)	Pack Wt KG Poids (kg)	Cubic Ft Pi3	Pack Contenu	List Price Liste des prix
YM-YST-050253-M48	Detachable Blue and White Strip Mop with 48" / 122 cm Metal Handle - 20" x 10" / 50 x 25 cm Vadrouille à bandes détachées bleues et blanches avec un manche en métal 48"/122cm - 20" x 10" / 50 x 25cm				12	\$ 9.91
YM-YST-05025	Detachable Blue and White Strip Mop - Refill - 20" x 10" / 50 x 25 cm / Rechange de vadrouille à bandes détachées bleues et blanches 20" x 10" / 50 x 25 cm				50/10	\$ 5.56

ECO STRIP MOP / VADROUILLE EN BANDES BLEUE ET BLANCHE



ECO STRIP - CUT END / BRINS COUPÉS										
	1	2	3	4	5	6	7	8	9	10
Durability / Durabilité										
Absorbency / Absorption										
Release / Capacité D'Évacuation										
Launderability / Blanchiment										
Performance / Performance										

M2 Code Code M2	Description	Pack Wt LB (S) Poids (lb) (S)	Pack Wt KG Poids (kg)	Cubic Ft Pi3	Pack Contenu	List Price Liste des prix
YM-YEC-11140-M48	Detachable Eco Strip Mop with 48" / 122 cm Metal Handle - Lint Free - 140 g / Vadrouille détachable Eco avec manche de métal 48"/122cm - sans peluche 140g				10	\$ 8.59
YM-YEC-11140	Detachable Eco Strip Mop Refill - Lint Free - 140 g / Rechange de vadrouille détachable Eco - sans peluche 140g				24	\$ 3.95

MICROFIBER MOP / VADROUILLE EN MICROFIBRE



MICROFIBER - LOOPED / FRANGES BOUCLÉES										
	1	2	3	4	5	6	7	8	9	10
Durability / Durabilité										
Absorbency / Absorption										
Release / Capacité D'Évacuation										
Launderability / Blanchiment										
Performance / Performance										

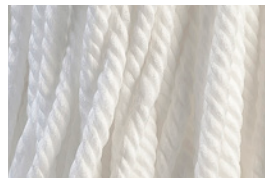

M2 Code Code M2	Description	Pack Wt LB (S) Poids (lb) (S)	Pack Wt KG Poids (kg)	Cubic Ft Pi3	Pack Contenu	List Price Liste des prix
YM-YMF-12200-M48	Detachable Microfiber Mop with 48" / 122 cm Metal Handle - 200 g / Vadrouille détachable en microfibre avec un manche de métal 48"/122cm - 200g				12	\$ 12.22
YM-YMF-12200	Detachable Microfiber Mop - Refill - 160 g / Rechange de vadrouille détachable - 160 g				48	\$ 8.36

ROLLER SPONGE MOP / VADROUILLE ÉPONGE RONDE						
M2 Code Code M2	Description	Pack Wt LB (S) Poids (lb) (S)	Pack Wt KG Poids (kg)	Cubic Ft Pi3	Pack Contenu	List Price Liste des prix
SM-R1025	10" / 25cm Roller Sponge mop / Vadrouille éponge ronde 10"/25cm					\$ 56.58
SM-R1025R	10" / 25cm Roller Sponge mop Refill / Rechange de vadrouille éponge ronde 10"/25cm					\$ 23.56



ROLLER SPONGE MOP / VADROUILLE ÉPONGE RONDE



DETATCHABLE YACHT MOPS

VADROUILLES "YACHT" DÉTACHABLES

- Loopy yacht mop is made with a strong durable connector with a universal handle socket
- Loopy is also available in a long lasting Rayon synthic yarn that will withstand repeated laundering and is economical

- La vadrouille bouclée "yacht" est fait d'un connecteur durable avec une douille de manche universelle.
- La vadrouille bouclée est aussi disponible dans un fil de rayonne synthétique durable qui résiste aux lavages répétés et est économique.



Can be made in colours.
Ask your representative
Peut être fait en couleurs
Demandez à votre représentant

- * Handles Sold Separately
- * Refer to page
- * Le manche est vendu séparément
- * Se reporter à la page

M2 Code Code M2	Description	Pack Wt LB (S) Poids (lb) (S)	Pack Wt KG Poids (kg)	Cubic Ft Pi3	Pack Contenu	List Price Liste des prix
LOOPY DETACHABLE YACHT MOP / VADROUILLE "YACHT" BOUCLÉE DÉTACHABLE						
YM-Y200	10 Oz./ 275 g Loopy Detachable Yacht Mop - Blue / 10 Oz./ 275 g Vadrouille "Yacht" bouclée détachable - bleu	7	3.5		12	\$ 12.13
YM-Y212	12 Oz./ 350 g Loopy Detachable Yacht Mop - Blue / 12 Oz./ 350 g Vadrouille "Yacht" bouclée détachable - bleu	10	4.5		12	\$ 15.86
SYNRAY CUT END LOOPY DETACHABLE YACHT MOP / VADROUILLE "YACHT" DÉTACHABLE 10OZ/275G SYNRAY BOUT COUPÉ						
YM-Y310	10 Oz./ 275 g Detachable Yacht Mop - SYNRAY Cut End / Vadrouille "Yacht" détachable 10oz/275g Synray bout coupé	8	3.5		12	\$ 11.47
YM-Y312	12 Oz. / 350 g Detachable Yacht Mop - SYNRAY Cut End / Vadrouille "Yacht" détachable 12oz/350g Synray bout coupé	10	4.5		12	\$ 12.48
YM-Y310-M348	10 / 275 g Detachable Yacht Mop - SYNRAY Cut End with 48" metal handle / Vadrouille "Yacht" détachable 10 / 275 g Synray bout coupé en manche de métal 48"				12	\$ 17.68
COTTON CUT END LOOPY DETACHABLE YACHT MO / VADROUILLE "YACHT" DÉTACHABLE 8 / 200 G COTTON BOUT COUPÉ						
YM-Y108C	8 / 200 g Detachable Yacht Mop - COTTON Cut End / Vadrouille "Yacht" détachable 8 / 200 g Cotton bout coupé	8	3.5		50/10	\$ 10.72
YM-Y110C	10 / 250 g Detachable Yacht Mop - COTTON Cut End / Vadrouille "Yacht" détachable 10 / 250 g Cotton bout coupé	10	4.5		40/10	\$ 11.02
YM-Y112C	12 / 300 g Detachable Yacht Mop - COTTON Cut End / Vadrouille "Yacht" détachable 12 / 300 g Cotton bout coupé				12	\$ 12.62
YM-Y116C	16 / 400 g Detachable Yacht Mop - COTTON Cut End / Vadrouille "Yacht" détachable 16 / 400 g Cotton bout coupé				12	\$ 15.47
YM-Y108C-M348M	8 / 225 g Detachable Yacht Mop - COTTON Cut End with 48" metal handle / Vadrouille "Yacht" détachable 8 / 225 g Cotton bout coupé. manche de métal 48"				12	\$ 11.69
YM-Y110C-M348M	10 / 275 g Detachable Yacht Mop - COTTON Cut End with 48" metal handle / Vadrouille "Yacht" détachable 10 / 275 g Cotton bout coupé. manche de métal 48"				12	\$ 11.99
YM-Y112C-M348M	12 / 350 g Detachable Yacht Mop - COTTON Cut End with 48" metal handle / Vadrouille "Yacht" détachable 12 / 350 g Cotton bout coupé. manche de métal 48"				12	\$ 14.72
YM-Y116C-M348M	16 / 450 g Detachable Yacht Mop - COTTON Cut End with 48" metal handle / Vadrouille "Yacht" détachable 16 / 450 g Cotton bout coupé. manche de métal 48"				12	\$ 16.52

DETATCHABLE YACHT MOPS / VADROUILLES «YACHT» DÉTACHABLES

Strong durable Deck/Yacht mops are made with a premium cotton yarn or synray yarn and wire bound to a wooden handle

Robustes, durables, les vadrouilles « yacht » sont fabriquées en fil de coton ou de synray de première qualité et attachées avec un fil métallique à un manche en bois.



All yacht mops
are individually bagged

Toutes les vadrouilles
« yacht » sont ensachées
individuellement.



M2 Code Code M2	Description	Pack Wt LB (S) Poids (lb) (S)	Pack Wt KG Poids (kg)	Cubic Ft Pi3	Pack Contenu	List Price Liste des prix
COTTON YACHT MOPS / VADROUILLE YACHT EN COTTON						
YM8	Cotton Yacht Mop with 48" Wooden Handle – 8 oz / 225 g / Vadrouille « yacht » en coton, 8 oz / 225 g, manche en bois de 48"	14	6.5	2	12	\$ 7.67
YM10	Cotton Yacht Mop with 48" Wooden Handle – 10 oz / 275 g / Vadrouille « yacht » en coton, 10 oz / 275 g, manche en bois de 48"	17	7.7	2	12	\$ 9.02
YM12	Cotton Yacht Mop with 48" Wooden Handle – 12 oz / 350 g / Vadrouille « yacht » en coton, 12 oz / 350 g, manche en bois de 48"	17	7.7	2	12	\$ 9.70
YM16	Cotton Yacht Mop with 48" Wooden Handle – 16 oz / 450 g / Vadrouille « yacht » en coton, 16 oz / 450 g, manche en bois de 48"	21.5	10	2.7	12	\$ 11.60
YM-HY8	Cotton Yacht Mop with 54" Wooden Handle – 8 oz / 225 g / Vadrouille « yacht » en coton, 8 oz / 225 g, manche en bois de 54"	14	6.5	2	12	\$ 12.42
YM-HY10	Cotton Yacht Mop with 54" Wooden Handle – 10 oz / 275 g / Vadrouille « yacht » en coton, 10 oz / 275 g, manche en bois de 54"	17	7.7	2	12	\$ 12.64
YM-HY12	Cotton Yacht Mop with 54" Wooden Handle – 12 oz / 350 g / Vadrouille « yacht » en coton, 12 oz / 350 g, manche en bois de 54"	17	7.7	2	12	\$ 13.59
YM-HY16	Cotton Yacht Mop with 54" Wooden Handle – 16 oz / 450 g / Vadrouille « yacht » en coton, 16 oz / 450 g, manche en bois de 54"	21.5	10	2.7	12	\$ 14.71
YM-HY20	Cotton Yacht Mop with 54" Wooden Handle – 20 oz / 550 g / Vadrouille « yacht » en coton, 20 oz / 550 g, manche en bois de 54"				12	\$ 16.47
SYNRAY YACHT MOPS / FAUBERTS SYNRAY						
YM-S8	Synray Yacht Mop with 48" Wooden Handle – 8 oz / 225 g / Vadrouille « yacht » Synray, 8 oz / 225 g, manche en bois de 48"	17	7.7	2	12	\$ 9.92
YM-S10	Synray Yacht Mop with 48" Wooden Handle – 10 oz / 275 g / Vadrouille « yacht » Synray, 10 oz / 275 g, manche en bois de 48"	17	7.7	2	12	\$ 11.19
YM-S10-54	Synray Yacht Mop with 54" Wooden Handle – 10 oz / 275 g / Vadrouille « yacht » Synray, 10 oz / 275 g, manche en bois de 54"	17	7.7	2	12	\$ 13.26
YM-S12	Synray Yacht Mop with 54" Wooden Handle – 12 oz / 350 g / Vadrouille « yacht » Synray, 12 oz / 350 g, manche en bois de 54"	17	7.7	2	12	\$ 13.37
YM-S16	Synray Yacht Mop with 54" Wooden Handle – 16 oz / 450 g / Vadrouille « yacht » Synray, 16 oz / 450 g, manche en bois de 54"	21.5	9.7	2.7	12	\$ 15.23
YM-S20	Synray Yacht Mop with 54" Wooden Handle – 20 oz / 550 g / Vadrouille « yacht » Synray, 20 oz / 550 g, manche en bois de 54"	21.5	9.7	2.7	12	\$ 17.38



STEP-N-GO

A NEW AND IMPROVED MOP HANDLE

UN NOUVEAU MANCHE DE VADROUILLE AMÉLIORÉ



- Foot pedal allows you to release the mop without touching the mop handle
- The mop hooks allow the user to lift the mop head without touching – easily grasping the soiled mop head and placing into a garbage receptacle or washing machine

- La pédale permet de libérer la vadrouille sans toucher le manche.
- Le crampon permet de soulever la vadrouille sans y toucher et de saisir facilement la tête de la vadrouille sale pour la mettre à la poubelle ou dans la lessiveuse

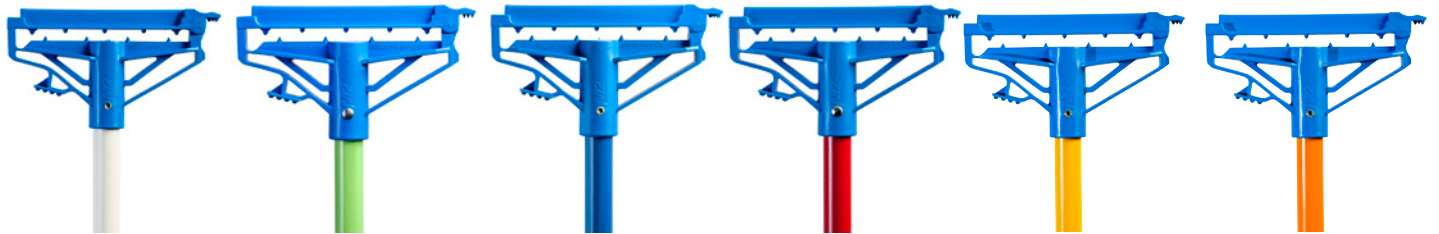

M2 Code Code M2	Description	Pack Wt LB (S) Poids (lb) (S)	Pack Wt KG Poids (kg)	Cubic Ft Pi3	Pack Contenu	List Price Liste des prix
HW-7001F	54" STEP-N-GO Fiberglass Mop Handle – Blue / Manche de vadrouille de fibre de verre STEP-N-GO, 54 po, bleu	20	9.5	7.92	12	\$ 25.63
HW-7000F	60" STEP-N-GO Fiberglass Mop Handle – Blue / Manche de vadrouille de fibre de verre STEP-N-GO, 60 po, bleu	21	9.6	7.92	12	\$ 28.39
HW-7000F-FD	60" STEP-N-GO Fiberglass Mop Handle with Plastic Rivet – Blue / Manche de vadrouille de fibre de verre avec rivet en plastique STEP-N-GO, 60 po, bleu	21	9.6	7.92	12	\$ 33.67
HW-7000F-WH	60" STEP-N-GO Fiberglass Mop Handle – White / Manche de vadrouille de fibre de verre STEP-N-GO, 60 po, blanc	21	9.6	7.92	12	\$ 30.53
HW-7000F-GN	60" STEP-N-GO Fiberglass Mop Handle – Green / Manche de vadrouille de fibre de verre STEP-N-GO, 60 po, vert	21	9.6	7.92	12	\$ 30.53
HW-7000F-RD	60" STEP-N-GO Fiberglass Mop Handle – Red / Manche de vadrouille de fibre de verre STEP-N-GO, 60 po, rouge	21	9.6	7.92	12	\$ 30.53
HW-7000F-YE	60" STEP-N-GO Fiberglass Mop Handle – Yellow / Manche de vadrouille de fibre de verre STEP-N-GO, 60 po, jaune	21	9.6	7.92	12	\$ 30.53
HW-7000F-OR	60" STEP-N-GO Fiberglass Mop Handle – Orange / Manche de vadrouille de fibre de verre STEP-N-GO, 60 po, orange	21	9.6	7.92	12	\$ 30.53

STEP-N-GO MOP HANDLE / MANCHE DE VADROUILLE STEP-N-GO

A VARIETY OF MOP HANDLES
ARE AVAILABLE./ DIVERS
MANCHES SONT DISPONIBLES.



M2 Code Code M2	Description	Pack Wt LB (S) Poids (lb) (S)	Pack Wt KG Poids (kg)	Cubic Ft Pi3	Pack Contenu	List Price Liste des prix
HW-7002W	54" STEP-N-GO Wooden Mop Handle / Manche de vadrouille en en bois, STEP-N-GO, 54 po	21	9.6	2.92	12	\$ 20.75
HW-7003M	60" STEP-N-GO Metal Mop Handle / Manche de vadrouille en métal, STEP-N-GO, 60 po	21	9.6	2.92	12	\$ 17.89
HW-7003A	60" STEP-N-GO Aluminum Mop Handle / Manche de vadrouille en aluminium, STEP-N-GO, 60 po	12	9.6	2.92	12	\$ 31.09
HW-7004A-TEL	60" STEP-N-GO Aluminum Telescopic Mop Handle / Manche de vadrouille télescopique en aluminium, STEP-N-GO, 60 po	21	9.6	2.92	12	\$ 41.16

SNAP-2-GO & SIDE CHANGE MOP HANDLES / MANCHE SNAP-2-GO ET DE VADROUILLE À CHANGEMENT DE CÔTÉ



M2 Code Code M2	Description	Pack Wt LB (S) Poids (lb) (S)	Pack Wt KG Poids (kg)	Cubic Ft Pi3	Pack Contenu	List Price Liste des prix
HW-8054F-BL	54" SNAP-2-GO Fiberglass Mop Handle - Blue / Manche de vadrouille de fibre de verre SNAP-2-GO, 54 po, bleu	21	9.6	7.92	12	\$ 23.43
HW-8060F-BL	60" SNAP-2-GO Fiberglass Mop Handle - Blue / Manche de vadrouille de fibre de verre SNAP-2-GO, 60 po, bleu	21	9.6	7.92	12	\$ 24.61
HW-8160-M	60" SNAP-2-GO Metal Mop Handle - Blue / Manche de vadrouille en métal SNAP-2-GO, 60 po, bleu	21	9.6	7.92	12	\$ 17.10
HW-9054F-BL	54" Side Change Mop handle FiberGlass Handle - Blue / Manche de vadrouille en fibre de verre 54" - Bleu				12	\$ 24.28
HW-9060F-BL	60" Side Change Mop handle FiberGlass Handle - Blue / Manche de vadrouille en fibre de verre 60" - Bleu				12	\$ 25.49
HW-9160-M	60" Side Change Mop handle Metal Handle - Blue / Manche de vadrouille en métal 60" - Bleu				12	\$ 17.75

QUICK CHANGE & JAW STYLE AND SCREW TYPE / MANCHES - CHANGEMENT RAPIDE, GENRE MÂCHOIRE OU STYLE VISÉ

Jaw Style mop handle easy to release mop by unscrewing the collar.
Available in both Fiberglass, metal and wood handle
Manche à mâchoire avec bague de serrement permettant une libération rapide de la vadrouille
Manche de fibre de verre, métal et en bois

PLEASE NOTE:

All our mops are available with our New Screw Top Handle.
Please enquire with your sales representative

S.v.p. notez:

Toutes nos vadrouilles sont disponibles avec notre nouveau manche visé.
S.v.p. informez auprès de votre représentant.



Quick Change Style Mop handle can accommodate narrow band and Wide band mops zinc plated to retard corrosion 1 1/8 wood handle.

Le manche de vadrouille à changement rapide s'adapte aux vadrouilles à bande étroite et à bande large. Plaqué zinc pour retarder la corrosion. Manche en bois de 1,1/8 po.



M2 Code Code M2	Description	Pack Wt LB (S) Poids (lb) (S)	Pack Wt KG Poids (kg)	Cubic Ft Pi3	Pack Contenu	List Price Liste des prix
QUICK CHANGE/ CHANGEMENT RAPIDE						
HW-145W	Quick Change - Wood Handle / Changement rapide, Manche en bois	28	13	2.92	12	\$ 17.67
HW-145M	Quick Change - Metal Handle / Changement rapide, Manche en metal	28	13	2.92	12	\$ 17.63
JAW STYLE / À MÂCHOIRES						
HW-160A	60"/152 cm Jaw Style with Aluminum handle - Yellow / À mâchoires avec manche de vadrouille en aluminium-60 po/152 cm, jaune	17	8	2.92	12	\$ 23.92
HW-160F	60"/152 cm Jaw Style with Fiberglass handle - Yellow / À mâchoires avec manche de fibre de verre-60 po/152 cm, jaune	17	8	2.92	12	\$ 28.26
HW-160M	60"/152 cm Jaw Style with Black Metal handle - Black / À mâchoires avec manche en métal, 60 po/152 cm - noir	13	6	2.92	12	\$ 18.70
HW-160W	Jaw Style with Wood handle / À mâchoires avec manche en bois	13	6	2.92	12	\$ 20.51
SCREW TYPE / MANCHE EN BOIS DE STYLE VISÉ						
HW-1254W	Screw Type Mop 54" Handle - Wood / Manche en bois de style visé 54"				12	\$ 24.99



STATIC-H

DUSTMOPS / VADROUILLES À ÉPOUSSETER

**Best in Dustmops
Meilleur dans les
vadrouilles à poussière**



**Universal backing /
Support universel**

STATIC-H - CUT END / BRINS COUPÉS										
	1	2	3	4	5	6	7	8	9	10
Durability / Durabilité										
Dust Capture / Capture de poussière										
Launderability / Blanchiment										
Performance / Performance										



M2 Code Code M2	Description	Pack Wt LB (S) Poids (lb) (S)	Pack Wt KG Poids (kg)	Cubic Ft Pi3	Pack Contenu	List Price Liste des prix
STATIC-H™ DUSTMOP – KEYHOLE BACKING – BLUE YARN / VADROUILLE À ÉPOUSSETER STATIC-H^{MD}, ENDOS KEYHOLE, BLEU						
DM-STH512-BL	STATIC-H – Refill – 5 x 12” – 13 x 30 cm / Recharge STATIC-H, 5 x 12 po, 13 x 30 cm	5.39	2.65	1.5	12/1	\$ 19.03
DM-STH518-BL	STATIC-H – Refill – 5 x 18” – 13 x 46 cm / Recharge STATIC-H, 5 x 18 po, 13 x 46 cm	9.5	4.3	1.5	12/1	\$ 22.80
DM-STH524-BL	STATIC-H – Refill – 5 x 24” – 13 x 61 cm / Recharge STATIC-H, 5 x 24 po, 13 x 61 cm	10.5	4.8	1.5	12/1	\$ 29.64
DM-STH536-BL	STATIC-H – Refill – 5 x 36” – 13 x 91 cm / Recharge STATIC-H, 5 x 36 po, 13 x 91 cm	15.5	7	1.8	12/1	\$ 44.02
DM-STH548-BL	STATIC-H – Refill – 5 x 48” – 13 x 122 cm / Recharge STATIC-H, 5 x 48 po, 13 x 122 cm	21	9.5	1.8	6/1	\$ 56.81
DM-STH560-BL	STATIC-H – Refill – 5 x 60” – 13 x 152 cm / Recharge STATIC-H, 5 x 60 po, 13 x 152 cm	25	11.3	1.8	6/1	\$ 67.48
DM-STH572-BL	STATIC-H – Refill – 5 x 72” – 13 x 182 cm / Recharge STATIC-H, 5 x 72 po, 13 x 182 cm				2/1	\$ 93.79
STATIC-H™ DUSTMOP – KEYHOLE BACKING – RED YARN / VADROUILLE À ÉPOUSSETER STATIC-H^{MD}, ENDOS KEYHOLE, ROUGE						
DM-STH518-RD	STATIC-H – Refill – 5 x 18” – 13 x 46 cm / Recharge STATIC-H, 5 x 18 po, 13 x 46 cm	9.5	4.3	1.5	12/1	\$ 22.80
DM-STH524-RD	STATIC-H – Refill – 5 x 24” – 13 x 61 cm / Recharge STATIC-H, 5 x 24 po, 13 x 61 cm	10.5	4.8	1.5	12/1	\$ 29.64
DM-STH536-RD	STATIC-H – Refill – 5 x 36” – 13 x 91 cm / Recharge STATIC-H, 5 x 36 po, 13 x 91 cm	15.5	7	1.8	12/1	\$ 44.02
DM-STH548-RD	STATIC-H – Refill – 5 x 48” – 13 x 122 cm / Recharge STATIC-H, 5 x 48 po, 13 x 122 cm	21	9.5	1.8	6/1	\$ 56.81
STATIC-H™ DUSTMOP – KEYHOLE BACKING – GREEN YARN / VADROUILLE À ÉPOUSSETER STATIC-H^{MD}, ENDOS KEYHOLE, VERT						
DM-STH518-GN	STATIC-H – Tie-on Refill – 5 x 18” – 13 x 46 cm / Recharge à œillet STATIC-H, 5 x 18 po, 13 x 46 cm	9.5	4.3	1.5	12/1	\$ 22.80
DM-STH524-GN	STATIC-H – Tie-on Refill – 5 x 24” – 13 x 61 cm / Recharge à œillet STATIC-H, 5 x 24 po, 13 x 61 cm	10.5	4.8	1.5	12/1	\$ 29.64
DM-STH536-GN	STATIC-H – Tie-on Refill – 5 x 36” – 13 x 91 cm / Recharge à œillet STATIC-H, 5 x 36 po, 13 x 91 cm	15.5	7	1.8	12/1	\$ 44.02
DM-STH548-GN	STATIC-H – Tie-on Refill – 5 x 48” – 13 x 122 cm / Recharge à œillet STATIC-H, 5 x 48 po, 13 x 122 cm	21	9.5	1.8	6/1	\$ 56.81
STATIC-H™ DUSTMOP – BREAKAWAY BACKING – BLUE / VADROUILLE À ÉPOUSSETER STATIC-H^{MD}, ENDOS BREAKAWAY, BLEU						
DMBA-STH518-BL	STATIC-H – BreakAway – 5 x 18” – 13 x 46 cm / Vadrouille à épousseter STATIC-H, 5 x 18 po, 13 x 46 cm	9.5	4.3	1.5	12/1	\$ 22.80
DMBA-STH524-BL	STATIC-H – BreakAway – 5 x 24” – 13 x 61 cm / Vadrouille à épousseter STATIC-H, 5 x 24 po, 13 x 61 cm	10.5	4.8	1.5	12/1	\$ 29.64
DMBA-STH536-BL	STATIC-H – BreakAway – 5 x 36” – 13 x 91 cm / Vadrouille à épousseter STATIC-H, 5 x 36 po, 13 x 91 cm	15.5	7	1.8	12/1	\$ 44.02
DMBA-STH548-BL	STATIC-H – BreakAway – 5 x 48” – 13 x 122 cm / Vadrouille à épousseter STATIC-H, 5 x 48 po, 13 x 122 cm	21	9.5	1.8	6/1	\$ 56.81

M-TECH MICROFIBER DUSTMOP STYLE - TIE-ON STYLE BACKING VADROUILLE À ÉPOUSSETER M-TECH - ENDOS TIE-ON

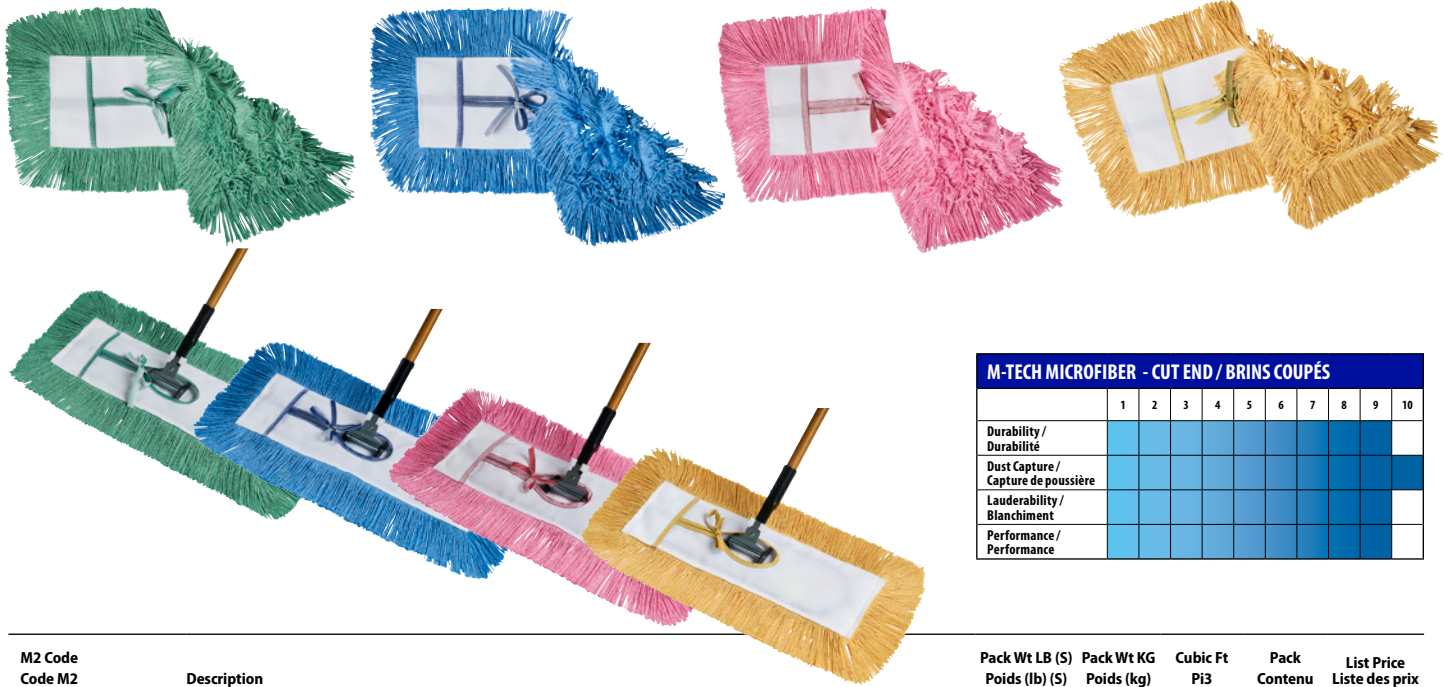

M-TECH MICROFIBER - CUT END / BRINS COUPÉS										
	1	2	3	4	5	6	7	8	9	10
Durability / Durabilité										
Dust Capture / Capture de poussière										
Launderability / Blanchiment										
Performance / Performance										

M2 Code Code M2	Description	Pack Wt LB (5) Poids (lb) (5)	Pack Wt KG Poids (kg)	Cubic Ft Pi3	Pack Contenu	List Price Liste des prix
M-TECH™ DUSTMOP – KEYHOLE BACKING – GREEN YARN / VADROUILLE À ÉPOUSSETER M-TECH™, ENDOS KEYHOLE, VERT						
DM-MT518-GN	M-TECH – Refill – 5 x 18" – 13 x 46 cm / Recharge M-TECH, 5 x 18 po, 13 x 46 cm	9.5	4.3	1.5	12/1	\$ 22.67
DM-MT524-GN	M-TECH – Refill – 5 x 24" – 13 x 61 cm / Recharge M-TECH, 5 x 24 po, 13 x 61 cm	10.5	4.8	1.5	12/1	\$ 27.26
DM-MT536-GN	M-TECH – Refill – 5 x 36" – 13 x 91 cm / Recharge M-TECH, 5 x 36 po, 13 x 91 cm	15.5	7	1.8	12/1	\$ 40.48
DM-MT548-GN	M-TECH – Refill – 5 x 48" – 13 x 122 cm / Recharge M-TECH, 5 x 48 po, 13 x 122 cm	21	9.5	1.8	6/1	\$ 51.75
DM-MT560-GN	M-TECH – Refill – 5 x 60" – 13 x 152 cm / Recharge M-TECH, 5 x 60 po, 13 x 152 cm	25	11.3	1.8	6/1	\$ 62.07
DM-MT572-GN	M-TECH – Refill – 5 x 72" – 13 x 182 cm / Recharge M-TECH, 5 x 72 po, 13 x 182 cm				2/1	\$ 74.80
M-TECH™ DUSTMOP – KEYHOLE BACKING – BLUE YARN / VADROUILLE À ÉPOUSSETER M-TECH™, ENDOS KEYHOLE, BLEU						
DM-MT518-BL	M-TECH – Refill – 5 x 18" – 13 x 46 cm / Recharge M-TECH, 5 x 18 po, 13 x 46 cm	9.5	4.3	1.5	12/1	\$ 22.67
DM-MT524-BL	M-TECH – Refill – 5 x 24" – 13 x 61 cm / Recharge M-TECH, 5 x 24 po, 13 x 61 cm	10.5	4.8	1.5	12/1	\$ 27.26
DM-MT536-BL	M-TECH – Refill – 5 x 36" – 13 x 91 cm / Recharge M-TECH, 5 x 36 po, 13 x 91 cm	15.5	7	1.8	12/1	\$ 40.48
DM-MT548-BL	M-TECH – Refill – 5 x 48" – 13 x 122 cm / Recharge M-TECH, 5 x 48 po, 13 x 122 cm	21	9.5	1.8	6/1	\$ 51.75
DM-MT560-BL	M-TECH – Refill – 5 x 60" – 13 x 152 cm / Recharge M-TECH, 5 x 60 po, 13 x 152 cm	25	11.3	1.8	6/1	\$ 62.07
DM-MT572-BL	M-TECH – Refill – 5 x 72" – 13 x 182 cm / Recharge M-TECH, 5 x 72 po, 13 x 182 cm				2/1	\$ 74.80
M-TECH™ DUSTMOP – KEYHOLE BACKING – RED YARN / VADROUILLE À ÉPOUSSETER M-TECH™, ENDOS KEYHOLE, ROUGE						
DM-MT518-RD	M-TECH – Refill – 5 x 18" – 13 x 46 cm / Recharge M-TECH, 5 x 18 po, 13 x 46 cm	9.5	4.3	1.5	12/1	\$ 22.67
DM-MT524-RD	M-TECH – Refill – 5 x 24" – 13 x 61 cm / Recharge M-TECH, 5 x 24 po, 13 x 61 cm	10.5	4.8	1.5	12/1	\$ 27.26
DM-MT536-RD	M-TECH – Refill – 5 x 36" – 13 x 91 cm / Recharge M-TECH, 5 x 36 po, 13 x 91 cm	15.5	7	1.8	12/1	\$ 40.48
DM-MT548-RD	M-TECH – Refill – 5 x 48" – 13 x 122 cm / Recharge M-TECH, 5 x 48 po, 13 x 122 cm	21	9.5	1.8	6/1	\$ 51.75
DM-MT560-RD	M-TECH – Refill – 5 x 60" – 13 x 152 cm / Recharge M-TECH, 5 x 60 po, 13 x 152 cm	25	11.3	1.8	6/1	\$ 62.07
DM-MT572-RD	M-TECH – Refill – 5 x 72" – 13 x 182 cm / Recharge M-TECH, 5 x 72 po, 13 x 182 cm				2/1	\$ 74.80
M-TECH™ DUSTMOP – KEYHOLE BACKING – YELLOW YARN / VADROUILLE À ÉPOUSSETER M-TECH™, ENDOS KEYHOLE, JAUNE						
DM-MT518-YE	M-TECH – Refill – 5 x 18" – 13 x 46 cm / Recharge M-TECH, 5 x 18 po, 13 x 46 cm	9.5	4.3	1.5	12/1	\$ 22.67
DM-MT524-YE	M-TECH – Refill – 5 x 24" – 13 x 61 cm / Recharge M-TECH, 5 x 24 po, 13 x 61 cm	10.5	4.8	1.5	12/1	\$ 27.26
DM-MT536-YE	M-TECH – Refill – 5 x 36" – 13 x 91 cm / Recharge M-TECH, 5 x 36 po, 13 x 91 cm	15.5	7	1.8	12/1	\$ 40.48
DM-MT548-YE	M-TECH – Refill – 5 x 48" – 13 x 122 cm / Recharge M-TECH, 5 x 48 po, 13 x 122 cm	21	9.5	1.8	6/1	\$ 51.75
DM-MT560-YE	M-TECH – Refill – 5 x 60" – 13 x 152 cm / Recharge M-TECH, 5 x 60 po, 13 x 152 cm	25	11.3	1.8	6/1	\$ 62.07
DM-MT572-YE	M-TECH – Refill – 5 x 72" – 13 x 182 cm / Recharge M-TECH, 5 x 72 po, 13 x 182 cm				2/1	\$ 74.80



MICRO-PET

MICROFIBER DUSTMOPS

VADROUILLES À ÉPOUSSETER EN MICROFIBRE MICRO PET

MICRO-PET - CUT END / BRINS COUPÉS										
	1	2	3	4	5	6	7	8	9	10
Durability / Durabilité										
Dust Capture / Capture de poussière										
Launderability / Blanchiment										
Performance / Performance										



MICRO-PET MICROFIBER DUSTMOP / VADROUILLE À ÉPOUSSETER EN MICROFIBRE "MICRO-PET"

- Launderable
- No treatment required
- Long lasting

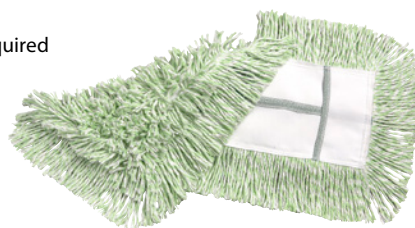

M2 Code Code M2	Description	Pack Wt LB (S) Poids (lb) (S)	Pack Wt KG Poids (kg)	Cubic Ft Pi3	Pack Contenu	List Price Liste des prix
DM-MPE518	Micro-Pet Microfiber Dustmop – 5 x 18"– 46 x 13cm / Vadrouille à épousseter en microfibre Micro-Pet, 5 x 18 po, 46 x 13cm	9.5	4.3	1.5	12/1	\$ 22.67
DM-MPE524	Micro-Pet Microfiber Dustmop – 5 x 24"– 61 x 13cm / Vadrouille à épousseter en microfibre Micro-Pet, 5 x 24 po, 61 x 13cm	10.5	4.8	1.5	12/1	\$ 27.26
DM-MPE536	Micro-Pet Microfiber Dustmop – 5 x 36"– 91 x 13cm / Vadrouille à épousseter en microfibre Micro-Pet, 5 x 36 po, 91 x 13cm	15.5	7	1.8	12/1	\$ 40.49
DM-MPE548	Micro-Pet Microfiber Dustmop – 5 x 48"– 122 x 13cm / Vadrouille à épousseter en microfibre Micro-Pet, 5 x 48 po, 122 x 13cm	21	9.5	1.8	6/1	\$ 51.75
DM-MPE560	Micro-Pet Microfiber Dustmop – 5 x 60"– 152 x 13cm / Vadrouille à épousseter en microfibre Micro-Pet, 5 x 60 po, 152 x 13cm	25	11.3	1.8	6/1	\$ 62.06
DM-MPE572	Micro-Pet Microfiber Dustmop – 5 x 72"– 182 x 13cm / Vadrouille à épousseter en microfibre Micro-Pet, 5 x 72 po, 182 x 13cm	4.6	2.1	1.25	2/1	\$ 74.80



M-TECH MICROFIBER DUSTMOP / VADROUILLE À ÉPOUSSETER EN MICROFIBRE M-TECH

- M-Tech Dustmop can be used wet or dry
- Next generation microfiber technology
- No chemicals or disinfectants needed – cleans better than all other microfiber mops
- Cleans and removes bacteria

- La vadrouille à épousseter M-tech s'utilise mouillée ou sèche.
- Technologie microfibre de nouvelle génération
- Aucuns produits chimiques ou désinfectants ne sont nécessaires; nettoie mieux que toutes les autres vadrouilles en microfibre.
- Nettoie et élimine les bactéries.

M-TECH MICROFIBER - CUT END / BRINS COUPÉS										
	1	2	3	4	5	6	7	8	9	10
Durability / Durabilité										
Dust Capture / Capture de poussière										
Launderability / Blanchiment										
Performance / Performance										

M2 Code Code M2	Description	Pack Wt LB (S) Poids (lb) (S)	Pack Wt KG Poids (kg)	Cubic Ft Pi3	Pack Contenu	List Price Liste des prix
DM-T518	M-Tech Microfiber Dustmop - Tie-on – 5 x 18"– 46 x 13cm / Vadrouille à épousseter en microfibre M-Tech - Attacher, 5 x 18 po, 46 x 13cm	9.5	4.3	1.5	12/1	\$ 26.67
DM-T524	M-Tech Microfiber Dustmop - Tie-on – 5 x 24"– 61 x 13cm / Vadrouille à épousseter en microfibre M-Tech - Attacher, 5 x 24 po, 61 x 13cm	10.5	4.8	1.5	12/1	\$ 33.15
DM-T536	M-Tech Microfiber Dustmop - Tie-on – 5 x 36"– 91 x 13cm / Vadrouille à épousseter en microfibre M-Tech - Attacher, 5 x 36 po, 91 x 13cm	15.5	7	1.8	12/1	\$ 48.08
DM-T548	M-Tech Microfiber Dustmop - Tie-on – 5 x 48"– 122 x 13cm / Vadrouille à épousseter en microfibre M-Tech - Attacher, 5 x 48 po, 122 x 13cm	21	9.5	1.8	12/1	\$ 62.82

G-STAT

LOOPED END DUSTMOP / VADROUILLES À ÉPOUSSETER EMBOUTS BOUCLÉS

G-STAT - LOOPED / FRANGES BOUCLÉES										
	1	2	3	4	5	6	7	8	9	10
Durability / Durabilité										
Dust Capture / Capture de poussière										
Launderability / Blanchiment										
Performance / Performance										



G-Stat dustmops are made with special long wearing yarn to help attract dust and dirt particles.

Made with a strong long wearing Polyester backing with reinforced stitching to prolong the life of the dustmop. Available in cut end or looped.

Les vadrouilles à épousseter G-Stat sont faites avec de longs fils spéciaux pour aider à attirer les particules de poussière et de saleté.

Fabriqué avec un support en polyester extra-fort avec coutures renforcées pour prolonger la vie de la vadrouille. Disponible en bouts coupés ou bouclés.

M2 Code Code M2	Description	Pack Wt LB (S) Poids (lb) (S)	Pack Wt KG Poids (kg)	Cubic Ft Pi3	Pack Contenu	List Price Liste des prix
G-STAT LOOPED END DUSTMOP / VADROUILLE À ÉPOUSSETER G-STAT À FRANGES BOUCLÉES						
DM-GST518-L-BL	G-STAT Dustmop – 5 x 18”– 46 x 13cm / G-STAT - vadrouilles à épousseter embouts bouclés, 5 x 18 po, 46 x 13cm	8.08	3.67		12/1	\$ 20.96
DM-GST524-L-BL	G-STAT Dustmop – 5 x 24”– 61 x 13cm / G-STAT - vadrouilles à épousseter embouts bouclés, 5 x 24 po, 61 x 13cm	11.71	5.32		12/1	\$ 24.77
DM-GST536-L-BL	G-STAT Dustmop – 5 x 36”– 91 x 13cm / G-STAT - vadrouilles à épousseter embouts bouclés, 5 x 36 po, 91 x 13cm	14.76	6.71		12/1	\$ 8.04
DM-GST548-L-BL	G-STAT Dustmop – 5 x 48”– 122 x 13cm / G-STAT - vadrouilles à épousseter embouts bouclés, 5 x 48 po, 122 x 13cm	21.54	9.79		6/1	\$ 47.33

G-STAT CUT END DUSTMOP / VADROUILLE À BRINS COUPÉS G-STAT



G-STAT CUT END DUSTMOP - KEYHOLE / VADROUILLE À BRINS COUPÉS G-STAT, ENDOS KEYHOLE						
DM-GST518-BL	G-STAT Dustmop – 5 x 18”– 46 x 13cm / G-STAT - vadrouilles à épousseter embouts bouclés, 5 x 18 po, 46 x 13cm	9.5	4.3	1.5	12/1	\$ 19.59
DM-GST524-BL	G-STAT Dustmop – 5 x 24”– 61 x 13cm / G-STAT - vadrouilles à épousseter embouts bouclés v, 5 x 24 po, 61 x 13cm	10.5	4.8	1.5	12/1	\$ 23.15
DM-GST536-BL	G-STAT Dustmop – 5 x 36”– 91 x 13cm / G-STAT - vadrouilles à épousseter embouts bouclés, 5 x 36 po, 91 x 13cm	15.5	7	1.8	12/1	\$ 35.55
DM-GST548-BL	G-STAT Dustmop – 5 x 48”– 122 x 13cm / G-STAT - vadrouilles à épousseter embouts bouclés, 5 x 48 po, 122 x 13cm	21	9.5	1.8	6/1	\$ 44.24
G-STAT CUT END DUSTMOP - BREAKAWAY - BLUE / VADROUILLE À BRINS COUPÉS G-STAT, ENDOS BREAKAWAY - BLEU						
DMBA-GST518-L-BL	G-STAT Dustmop – 5 x 18”– 46 x 13cm / G-STAT - vadrouilles à épousseter embouts bouclés, 5 x 18 po, 46 x 13cm	9.5	4.3	1.5	12/1	\$ 20.96
DMBA-GST524-L-BL	G-STAT Dustmop – 5 x 24”– 61 x 13cm / G-STAT - vadrouilles à épousseter embouts bouclés v, 5 x 24 po, 61 x 13cm	10.5	4.8	1.5	12/1	\$ 24.77
DMBA-GST53-6L-BL	G-STAT Dustmop – 5 x 36”– 91 x 13cm / G-STAT - vadrouilles à épousseter embouts bouclés, 5 x 36 po, 91 x 13cm	15.5	7	1.8	12/1	\$ 38.04
DMBA-GST548-L-BL	G-STAT Dustmop – 5 x 48”– 122 x 13cm / G-STAT - vadrouilles à épousseter embouts bouclés, 5 x 48 po, 122 x 13cm	21	9.5	1.8	6/1	\$ 47.33
G-STAT CUT END DUSTMOP - BREAKAWAY - YELLOW / VADROUILLE À BRINS COUPÉS G-STAT, ENDOS BREAKAWAY - JAUNE						
DMBA-GST518-YE	G-STAT Dustmop – 5 x 18”– 46 x 13cm - Yellow / G-STAT - vadrouilles à épousseter embouts bouclés, 5 x 18 po, 46 x 13cm - jaune	9.5	4.3	1.5	12/1	\$ 19.59
DMBA-GST524-YE	G-STAT Dustmop – 5 x 24”– 61 x 13cm - Yellow / G-STAT - vadrouilles à épousseter embouts bouclés v, 5 x 24 po, 61 x 13cm - jaune	10.5	4.8	1.5	12/1	\$ 23.15
DMBA-GST536-YE	G-STAT Dustmop – 5 x 36”– 91 x 13cm - Yellow / G-STAT - vadrouilles à épousseter embouts bouclés, 5 x 36 po, 91 x 13cm - jaune	15.5	7	1.8	12/1	\$ 35.55
DMBA-GST548-YE	G-STAT Dustmop – 5 x 48”– 122 x 13cm - Yellow / G-STAT - vadrouilles à épousseter embouts bouclés, 5 x 48 po, 122 x 13cm - jaune	21	9.5	1.8	6/1	\$ 44.24

COTTON DUSTMOPS / VADROUILLE À ÉPOUSSETER EN COTON



3" / 7.6 cm width available upon request /
Largeur 3"/7.6 cm disponible sur demande

M2 Professional style cotton Dustmops are made with one of the highest grades of cotton yarn and are designed for areas where laundering is not possible.

- Ideal for areas embedded with dirt and soil.
- An economical choice

Les vadrouilles à épousseter professionnelles en coton M2 sont fabriquées avec du fil de coton de la plus haute qualité et sont conçues pour les endroits où il n'y a pas de laverie.

- Idéales pour déloger la saleté incrustée
- Un choix économique

COTTON - CUT END / BRINS COUPÉS										
	1	2	3	4	5	6	7	8	9	10
Durability / Durabilité										
Dust Capture / Capture de poussière										
Launderability / Blanchiment										
Performance / Performance										

* Launderable but not highly recommended
* Lavable mais pas fortement recommandé

M2 Code Code M2	Description	Pack Wt LB (S) Poids (lb) (S)	Pack Wt KG Poids (kg)	Cubic Ft Pi3	Pack Contenu	List Price Liste des prix
5" / 13 cm Tie-on Refill						
DM-C518	Cotton Dustmop - Tie-on - 5 x 18" - 13 x 46 cm / Vadrouille à épousseter en coton à œillet, 5 x 18 po, 13 x 46 cm	10	4.5	1	12/1	\$ 17.15
DM-C524	Cotton Dustmop - Tie-on - 5 x 24" - 13 x 61 cm / Vadrouille à épousseter en coton à œillet, 5 x 24 po, 13 x 61 cm	13	6	1	12/1	\$ 20.75
DM-C536	Cotton Dustmop - Tie-on - 5 x 36" - 13 x 91 cm / Vadrouille à épousseter en coton à œillet, 5 x 36 po, 13 x 91 cm	18	8	1	12/1	\$ 36.84
DM-C548	Cotton Dustmop - Tie-on - 5 x 48" - 13 x 122 cm / Vadrouille à épousseter en coton à œillet, 5 x 48 po, 13 x 122 cm	21	10	1	6/1	\$ 40.84
DM-C560	Cotton Dustmop - Tie-on - 5 x 60" - 13 x 152 cm / Vadrouille à épousseter en coton à œillet, 5 x 60 po, 13 x 152 cm				6/1	\$ 55.54
DM-C572	Cotton Dustmop - Tie-on - 5 x 72" - 13 x 182 cm / Vadrouille à épousseter en coton à œillet, 5 x 72 po, 13 x 182 cm				2/1	\$ 62.87
5" / 13 cm Breakaway Refill						
DMBA-C518	Cotton Dustmop - Breakaway - 5 x 18" - 13 x 46 cm / Vadrouille à épousseter en coton à œillet, 5 x 18 po, 13 x 46 cm	10	4.5	1	12	\$ 14.55
DMBA-C524	Cotton Dustmop - Breakaway - 5 x 24" - 13 x 61 cm / Vadrouille à épousseter en coton à œillet, 5 x 24 po, 13 x 61 cm	13	6	1	12	\$ 17.61
DMBA-C536	Cotton Dustmop - Breakaway - 5 x 36" - 13 x 91 cm / Vadrouille à épousseter en coton à œillet, 5 x 36 po, 13 x 91 cm	18	8	1	12	\$ 27.85
DMBA-C548	Cotton Dustmop - Breakaway - 5 x 48" - 13 x 122 cm / Vadrouille à épousseter en coton à œillet, 5 x 48 po, 13 x 122 cm	21	10	1	12	\$ 34.65

PRO TWIST DUST MOP - BLUE



VALUE ECONOMY - CUT END / BRINS COUPÉS										
	1	2	3	4	5	6	7	8	9	10
Durability / Durabilité										
Dust Capture / Capture de poussière										
Launderability / Blanchiment										
Performance / Performance										

* Launderable but not highly recommended
* Lavable mais pas fortement recommandé

M2 Code Code M2	Description	Pack Wt LB (S) Poids (lb) (S)	Pack Wt KG Poids (kg)	Cubic Ft Pi3	Pack Contenu	List Price Liste des prix
DM-VE518-BL	Universal Pro Twist Dustmop - Tie-on - 5 x 18" - 13 x 46 cm / 5 x 18 po, 13 x 46 cm				12	\$ 13.62
DM-VE524-BL	Universal Pro Twist Dustmop - Tie-on - 5 x 24" - 13 x 61 cm / 5 x 24 po, 13 x 61 cm				12	\$ 16.65
DM-VE536-BL	Universal Pro Twist Dustmop - Tie-on - 5 x 36" - 13 x 91 cm / 5 x 36 po, 13 x 91 cm				12	\$ 22.70
DM-VE548-BL	Universal Pro Twist Dustmop - Tie-on - 5 x 48" - 13 x 122 cm / 5 x 48 po, 13 x 122 cm				12	\$ 27.09

SCRUBBY



M2 Code Code M2	Description	Pack Wt LB (S) Poids (lb) (S)	Pack Wt KG Poids (kg)	Cubic Ft Pi3	Pack Contenu	List Price Liste des prix
SC-7490	Scrubby Foot Pad - Scuff and Shoe Mark Remover - Fits on Mop Handle - Blue / Tampon à pied pour récurer les éraflures et les marques de soulier - s'adapte au manche de vadrouille - bleu				10/Bag	\$ 13.67

DISPOSABLE COTTON DUSTMOPS / JETABLE VADROUILLE À ÉPOUSSETER EN COTON

COTTON - CUT END / BRINS COUPÉS										
	1	2	3	4	5	6	7	8	9	10
Durability / Durabilité										
Dust Capture / Capture de poussière										
Launderability / Blanchiment										
Performance / Performance										



M2 Code Code M2	Description	Pack Wt LB (S) Poids (lb) (S)	Pack Wt KG Poids (kg)	Cubic Ft Pi3	Pack Contenu	List Price Liste des prix
DM-DP18	Disposable Cotton Dustmop – Tie-on – 5 x 18” – 13 x 46 cm / Jetable Vadrouille à épousseter en Coton à œillet, 5 x 18 po, 13 x 46 cm	10	4.5	1	12	\$ 14.60
DM-DP24	Disposable Cotton Dustmop – Tie-on – 5 x 24” – 13 x 61cm / Jetable Vadrouille à épousseter en Coton à œillet, 5 x 24 po, 13 x 61cm	13	6	1	12	\$ 17.15
DM-DP36	Disposable Cotton Dustmop – Tie-on – 5 x 36” – 13 x 91cm / Jetable Vadrouille à épousseter en Coton à œillet, 5 x 36 po, 13 x 91cm	18	8	1	12	\$ 22.92
DM-DP48	Disposable Cotton Dustmop – Tie-on – 5 x 48” – 13 x 122 cm / Jetable Vadrouille à épousseter en Coton à œillet, 5 x 48 po, 13 x 122 cm	21	10	1	6/1	\$ 30.01
DM-DP60	Disposable Cotton Dustmop – Tie-on – 5 x 60” – 13 x 152 cm / Jetable Vadrouille à épousseter en Coton à œillet, 5 x 60 po, 13 x 152 cm				6/1	\$ 36.31
DM-DP72	Disposable Cotton Dustmop – Tie-on – 5 x 72” – 13 x 182 cm / Jetable Vadrouille à épousseter en Coton à œillet, 5 x 72 po, 13 x 182 cm				2/1	\$ 48.07



CLIPPER FRAME & HANDLE / CADRE ET MANCHE «CLIPPER»

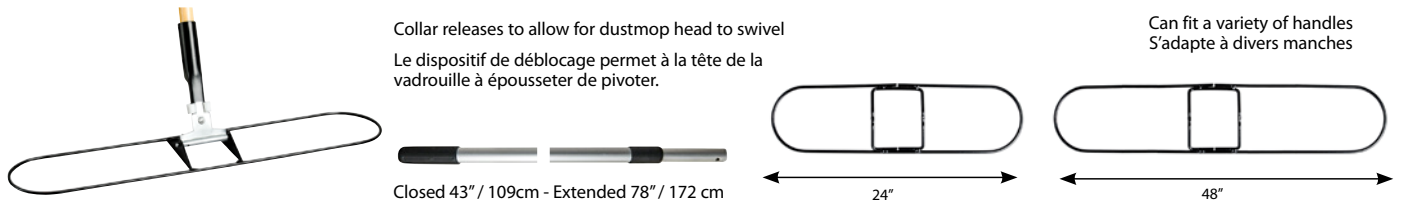

M2 Code Code M2	Description	Pack Wt LB (S) Poids (lb) (S)	Pack Wt KG Poids (kg)	Cubic Ft Pi3	Pack Contenu	List Price Liste des prix
CLIPPER FRAME / CADRE « CLIPPER »						
DF-CL518	Clipper Frame Only – 5 x 18" – 13 x 46 cm / Clipper» seulement, 5 x 18 po / 13 x 46 cm	19	8.5		12/1	\$ 9.93
DF-CL524	Clipper Frame Only – 5 x 24" – 13 x 61 cm / Clipper» seulement, 5 x 24 po / 13 x 61 cm	20	9		12/1	\$ 11.15
DF-CL536	Clipper Frame Only – 5 x 36" – 13 x 91 cm / Clipper» seulement, 5 x 36 po / 13 x 91 cm	22	10		12/1	\$ 13.27
DF-CL548	Clipper Frame Only – 5 x 48" – 13 x 122 cm / Clipper» seulement, 5 x 48 po / 13 x 122 cm	28	12.5		12/1	\$ 23.03
DF-CL560	Clipper Frame Only – 5 x 60" – 13 x 152 cm / Clipper» seulement, 5 x 60 po / 13 x 152 cm	28	12.5		12/1	\$ 27.91
DF-CL572	Clipper Frame Only – 5 x 72" – 13 x 182 cm / Clipper» seulement, 5 x 72 po / 13 x 182 cm	28.5	13		12/1	\$ 37.72



CLIPPER HANDLES / MANCHES						
DF-CL60	60" Clipper Handle – Wood / Manche « Clipper », 60 po, en bois	7.7	17		12/1	\$ 15.43
DF-CL60-M	60" Clipper Metal Handle / Manche en métal « Clipper », 60 po	7	5.5		12/1	\$ 20.62
DF-CL60-A	60" Clipper Aluminum Handle / Manche en aluminium « Clipper », 60 po	7	15.5		12/1	\$ 22.25
DF-CL54-F	54" Clipper Fibreglass Handle – Blue / Manche de fibre de verre « Clipper », 54po, bleu	7	5.5		12/1	\$ 26.85
DF-CL60-F	60" Clipper Fibreglass Handle – Blue / Manche de fibre de verre « Clipper », 60po, bleu	7	5.5		12/1	\$ 29.03
DF-CL60-F-Colour	60" Clipper Fibreglass Handle – Blue / Manche de fibre de verre « Clipper », 60 po	7.7	17		12/1	\$ 29.03
DF-CL60-Ext	Clipper Telescopic Non Threaded Handle - 43" / 109cm Closed / Manche télescopique non fileté 43" po / 109cm				20/1	\$ 33.33

SNAPPER FRAME & HANDLE / CADRE ET MANCHE «SNAPPER»



SNAPPER FRAMES / CADRES « SNAPPER »						
DF-SN518	Snapper Frame Only – 5 x 18" – 13 x 46 cm / Cadre « Snapper » seulement, 5 x 18 po / 13 x 46 cm	11.5	5	.3	12/1	\$ 9.68
DF-SN524	Snapper Frame Only – 5 x 24" – 13 x 61 cm / Cadre « Snapper » seulement, 5 x 24 po / 13 x 61 cm	13	6	.4	12/1	\$ 10.85
DF-SN536	Snapper Frame Only – 5 x 36" – 13 x 91 cm / Cadre « Snapper » seulement, 5 x 36 po / 13 x 91 cm	15	7	.6	12/1	\$ 13.51
DF-SN548	Snapper Frame Only – 5 x 48" – 13 x 122 cm / Cadre « Snapper » seulement, 5 x 48 po / 13 x 122 cm	22	10	.8	12/1	\$ 23.08
DF-SN560	Snapper Frame Only – 5 x 60" – 13 x 152 cm / Cadre « Snapper » seulement, 5 x 60 po / 13 x 152 cm				12/1	\$ 28.16
DF-SN572	Snapper Frame Only – 5 x 72" – 13 x 182 cm / Cadre « Snapper » seulement, 5 x 72 po / 13 x 182 cm				12/1	\$ 53.96
SNAPPER HANDLE / MANCHES « SNAPPER »						
DF-SN60-W	Snapper Dustmop Handle – Wood / Manche de vadrouille à épousseter « Snapper », en bois	20.7	9.5		10/1	\$ 20.71
DF-SN60-A	60" Snapper Aluminum Handle / Manche en aluminium « Clipper », 60 po	7	15.5		10/1	\$ 26.17
DF-SN60-F	60" Snapper Fibreglass Handle / Manche de fibre de verre « Snapper » 60 po	20.7	9.5		10/1	\$ 28.20
DF-SN60-M	Snapper Metal Handle / Manche en métal « Snapper »	20.7	9.5		10/1	\$ 28.27
DF-SN60-F - Colour	Snapper Fibreglass Handle / Manche de fibre de verre « Snapper »	20.7	9.5		10/1	\$ 29.96
DF-SN60-EXT	Snapper Telescopic Non Threaded Handle - 43" / 109cm Closed / Manche télescopique non fileté 43" po / 109cm	7.8	3.5		10/1	\$ 47.02

BREAK-EZY FRAME & HANDLE / CADRE ET MANCHE «BREAK-EZY»

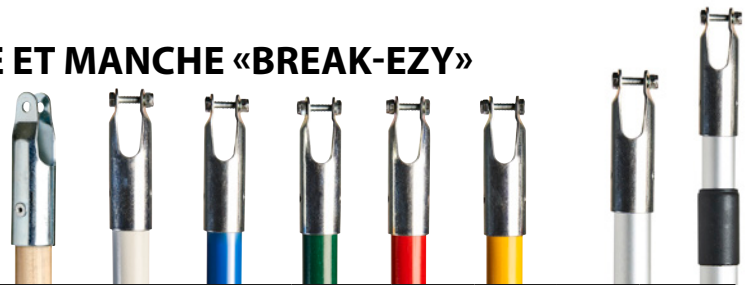
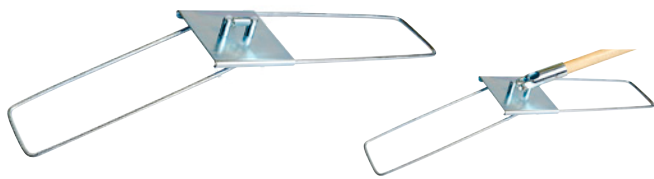

M2 Code Code M2	Description	Pack Wt LB (S) Poids (lb) (S)	Pack Wt KG Poids (kg)	Cubic Ft Pi3	Pack Contenu	List Price Liste des prix
DF-EZY518	Break-Ezy Frame Only – 5 x18” – 13 x 46 cm / Cadre « BreakEzy » seulement, 5 x18 po / 13 x 46 cm	18.7	8.5	.7	22/1	\$ 26.20
DF-EZY524	Break-Ezy Frame Only – 5 x 24” – 13 x 61cm / Cadre « BreakEzy » seulement, 5 x 24 po / 13 x 61cm	20	9	.8	10/1	\$ 27.45
DF-EZY536	Break-Ezy Frame Only – 5 x 36” – 13 x 91cm / Cadre « BreakEzy » seulement, 5 x 36 po / 13 x 91cm	22	10	1.1	15/1	\$ 34.94
DF-EZY548	Break-Ezy Frame Only – 5 x 48” – 13 x 122 cm / Cadre « BreakEzy » seulement, 5 x 48 po / 13 x 122 cm	27.5	12.5	1.3	15/1	\$ 38.68
DF-EZY60	Break-Ezy Wood Handle / Manche de bois “Break-Ezy”	17	7.7		12/1	\$ 14.66
DF-EZY518-H	Break-Ezy Frame & 60” Handle – 5 x18” – 13 x 46 cm / Cadre « BreakEzy » seulement, 5 x18 po / 13 x 46 cm				5	\$ 44.03
DF-EZY524-H	Break-Ezy Frame & 60” Handle – 5 x 24” – 13 x 61cm / Cadre « BreakEzy » seulement, 5 x 24 po / 13 x 61cm				5	\$ 45.22
DF-EZY536-H	Break-Ezy Frame & 60” Handle – 5 x 36” – 13 x 91cm / Cadre « BreakEzy » seulement, 5 x 36 po / 13 x 91cm				5	\$ 53.55
DF-EZY548-H	Break-Ezy Frame & 60” Handle – 5 x 48” – 13 x 122 cm / Cadre « BreakEzy » seulement, 5 x 48 po / 13 x 122 cm				3	\$ 58.31
DF-EZY60F - Colours	Break-Ezy Fibreglass Handle / Manche de Fibreglss “Break-Ezy”	17	7.7		12/1	\$ 29.43
DF-EZY60-AL	60/152 cm Break-Ezy Aluminum Handle / Manche de bois “Break-Ezy” avec manche en aluminium - 60/152 cm				12/1	\$ 20.63
DF-EZY60-EXT	Break-Ezy Telescopic Handle Handle– Closed 68”/109 cm - Extended 68”x 172 cm / Manche télescopique Break-Ezy - fermée 68”/ 109 cm - étendue 68”x 172 cm				12/1	\$ 33.10



SCISSOR MOP VADROUILLE CISEAU

- Used in large warehouse, gymnasiums, airports or any open large area.
- Spans a maximum of 193 cm / 76 inch allowing you to adjust for various widths for easy passage through narrow door ways
- Scissor mop come with 2 ea 97cm / 38 inch
- Static-H dustmops that can be laundered

- Utilisé dans les grands entrepôts et les gymnases, les aéroports ou tous les grands espaces ouverts.
- Envergure de 193 cm / 76 po. permettant de s'ajuster à différentes largeurs pour le passage facile à travers des portes étroites.
- La vadrouille ciseau vient en paquet de 2 97 cm / 38 po.
- La vadrouille “Static-H” peut être lavée.

DF-SC2999FH	Scissor Mop Frame & Handle / Cadre et vadrouille en ciseau	8.5	3.9		1	\$ 196.49
DM-SC2999-2	Scissor Mop Refills Includes one set (2 included) / Recharge de vadrouille en ciseau (2 incluses)	2	.8		1	\$ 95.48



Refer to page for retail packaging

Voir page pour les emballages de vente au détail

HOUSEHOLD DUSTMOP COMPLETE VADROUILLE À ÉPOUSSETER DOMESTIQUE COMPLET

DM-H1216	Household Dustmop Complete with Frame, Dustmop and 48” Handle / Ensemble domestique complet avec cadre, vadrouille et manche 48”	5.3	2.4		6	\$ 25.49
DM-H1216R	Household Dustmop Refill Only / Remplacement de vadrouille domestique seulement	2	.9		12/1	\$ 14.56
DM-H1216F	Household Dustmop Frame Only /				6/1	\$ 16.39



Refer to page for retail packaging

Voir page pour les emballages de vente au détail

ALL-IN-ONE DUSTMOPS COMBOS / ENSEMBLE VADROUILLE À ÉPOUSSETER

DM-ALO518	All-In-One Dust Mop Combos – 5 x18”/46cm x 13 cm – Blue / Ensemble vadrouille à épousseter, 5 x18 po/46cm x 13 cm, bleu	2.9	1.2	.70	1	\$ 54.49
DM-ALO524	All-In-One Dust Mop Combos – 5 x 24”/61cm x 13 cm – Blue / Ensemble vadrouille à épousseter, 5 x 24 po/61cm x 13 cm, bleu	3	1.4	.70	1	\$ 65.26
DM-ALO536	All-In-One Dust Mop Combos – 5 x 36”/91 cm x 13 cm – Blue / Ensemble vadrouille à épousseter, 5 x 36 po/91 cm x 13 cm, bleu	4	1.8	.70	1	\$ 82.40
DM-ALO548	All-In-One Dust Mop Combos – 5 x 48”/122 cm x 13 cm – Blue / Ensemble vadrouille à épousseter, 5 x 48 po/122 cm x 13 cm, bleu	5	2.3	.70	1	\$ 108.99



DOODLE BUG WALL WASHING SYSTEMS / SYSTÈMES DE LAVAGE DES MURS DOODLE BUG

- Doodle bugs are made of strong plastic available in two size 9" & 11"
- 9" has a universal handle design
- 11" has a threaded handle design
- Can be used to scrub and wash walls and tight areas

- Fabriqués en plastique robuste; deux tailles (9 po et 11 po)
- Le système 9 po a un manche universel.
- Le système 11 po a un manche fileté.
- Pour frotter et laver les murs et les zones difficiles à atteindre



Accepts threaded handle / Accepte la poignée fileté



WW-1749 Accepts any
15/16" Handle /
Accepte tout poignée 15/16"



M2 Code Code M2	Description	Pack Wt LB (S) Poids (lb) (S)	Pack Wt KG Poids (kg)	Cubic Ft Pi3	Pack Contenu	List Price Liste des prix
WW-1749	9" Doodle Bug – Frame only / Cadre « Doodle Bug » seulement, 9 po	19	8.6	1.5	12/1	\$ 14.54
WW-17411	11" Doodle Bug – Frame only – Accepts Threaded Handle / Cadre «Doodle Bug» seulement, 11 po, s'adapte au manche fileté	18	8.	1.4	12/1	\$ 14.77

DOODLE BUG WALL WASHING REFILLS / RECHARGES POUR LAVAGE DE MURS «DOODLE BUG»

CUT END & LOOPED END MICROFIBER

- Refills are absorbent and long lasting
- Velcro backing securely attaches the refill to the frame

MICROFIBRE À BRINS COUPÉS OU BOUCLÉS

- Rechange sont absorbent et durable
- Le revers en velcro attache solidement la recharge au cadre.



Microfiber / Microfibre



DOODLE BUG - MICROFIBER - CUT END / BRINS COUPÉS - Grey/Gris	1	2	3	4	5	6	7	8	9	10
Durability / Durabilité										
Dust Capture / Capture de poussière										
Launderability / Blanchiment										
Performance / Performance										

DOODLE BUG - MICROFIBER - LOOPED / FRANGES BOUCLÉES - Blue/Bleu	1	2	3	4	5	6	7	8	9	10
Durability / Durabilité										
Dust Capture / Capture de poussière										
Launderability / Blanchiment										
Performance / Performance										

DOODLE BUG - COTTON - CUT END / BRINS COUPÉS	1	2	3	4	5	6	7	8	9	10
Durability / Durabilité										
Dust Capture / Capture de poussière										
Launderability / Blanchiment										
Performance / Performance										

WW-18411-GY	12" / 30 cm Doodle Bug Cut End - Refill Only Microfiber - Velcro - Grey									12/1	\$ 17.03
WW-18411-BL	12" / 30 cm Doodle Bug Cut End - Refill Only Microfiber - Velcro - Blue									12/1	\$ 17.03
	12" / 30 cm Doodle Bug Cut End - Refill Only Microfiber - Velcro - Red									12/1	\$ 17.03
WW-18411-GN	12" / 30 cm Doodle Bug Cut End - Refill Only Microfiber - Velcro - Green									12/1	\$ 17.03
WW-18411-YE	12" / 30 cm Doodle Bug Cut End - Refill Only Microfiber - Velcro - Yellow									12/1	\$ 17.03
WW-18412	10" / 25 cm Doodle Bug Cut End - Refill Only Cotton - Velcro									12/1	\$ 17.95
WW-18413	10" / 25 cm Doodle Bug Cut End - Frame & Refill - Cotton - Velcro									12/1	\$ 17.95
WW-1849	9" / 22 cm Doodle Bug Microfiber Refill only - Velcro - Cut End - Grey / 9 po / 22 cm Rechange en microfibre "Doodle Bug" seulement, brins coupés - gris	4.2	2							12/1	\$ 15.41
WW-1850	9" / 22 cm Doodle Bug Microfiber Refill only - Looped End / 9 po / 22 cm Rechange en microfibre "Doodle Bug" seulement - Brins bouclés	4.2	2							12/1	\$ 15.74
MFP-4010-BL	11" / 28cm MicroFiber Pads - Blue / Tampons M-Fibre 11" / 28cm - bleu									12/1	\$ 9.96
WW-940-01	3.5 x 7.5" Microfiber with Key Hole tie on style for Metal Frame – Refill Only / Microfibre avec trou pour oeillet pour cadre métallique - 3.5 x 7.5" - recharge seulement									12/1	\$ 15.41
WW-940-02	3.5 x 7.5" Cotton with Key Hole tie on style for Metal Frame – Refill Only / Cotton avec trou pour oeillet pour cadre métallique - 3.5 x 7.5 po - recharge seulement									12/1	\$ 15.32

DUSTERS / BROSSES À POUSSIÈRE

MICROFIBER / MICROFIBRE

Dusters can be used for high dusting and to clean difficult to reach areas

À utiliser pour dépeussier en hauteur et dans les endroits difficiles à atteindre.

* Handles Sold Separately
* FH-A3180 on Page

* Le manche est vendu séparément
* FH-A3180 à la page



M2 Code Code M2	Description	Pack Wt LB (S) Poids (lb) (S)	Pack Wt KG Poids (kg)	Cubic Ft Pi3	Pack Contenu	List Price Liste des prix
DU-M8500	Duster-Frame Flexible – 22" / 55 cm / Support de dépeussierage microfibre souple, 22 po / 55 cm	.7	.4	3	12/1	\$ 20.28
DU-M8501	Microfiber Refill Sleeve – 22" 55 cm - blue / Rechange manchon de dépeussierage microfibre, 22 po / 55 cm - bleu	.2	.09	4	12/1	\$ 14.08
DU-M8502	Microfiber Duo Refill Sleeve – 22" 55 cm - Grey / Rechange microfibre Duo - 22"/55cm - gris	.2	.09	4	12/1	\$ 35.64
DU-M8503	Microfiber Duo Sided Cut Fiber/w/Fringe Refill Sleeve-Green – 22" 55 cm / Microfibre 2 cotés avec bout coupé/bande de rechange verte 22" 55 cm	.2	.09	4	12/1	\$ 24.69
FH-A3180	Telescopic Non Threaded Handle - 100 - 180 cm / Manche télescopique non fileté 100"/180 cm				20/1	\$ 20.97

DUSTERS / PLUMEAUX

DUSTING BRUSH / BROSSE À ÉPOUSSETER



PIPE DUCT BRUSH / BROSSE POUR TUYAUX

Bendable head to wrap around pipes /
Pliable pour entourer les tuyaux

TAKES STANDARD
ACME HANDLE WITH
ADAPTER

UTILISE UNE POIGNÉE
STANDARD ACME
AVEC ADAPTATEUR

M2 Code Code M2	Description	Pack Wt LB (S) Poids (lb) (S)	Pack Wt KG Poids (kg)	Cubic Ft Pi3	Pack Contenu	List Price Liste des prix
WS-AC005	Ceiling Fan Dusting Brush / Brosse à épousseter	3.3	1.5	.77	10/1	\$ 16.98
WS-AC006	Pipe Duct Brush / Brosse pour tuyaux	2.9	1.3	.77	20/1	\$ 22.64



M2 Code Code M2	Description	Pack Wt LB (S) Poids (lb) (S)	Pack Wt KG Poids (kg)	Cubic Ft Pi3	Pack Contenu	List Price Liste des prix
FH-A35	Threaded to Tapered Adapter / Adaptateur conique fileté				12/1	\$ 3.37
FH-W360-1T	Tapered 1" x 60" / À bout fuselé 1 po x 60 po	37.5	17	1	25/12	\$ 7.91



DUSTERS / PLUMEAUX

FLEXIBLE LAMBS WOOL DUSTER / PLUMEAU EN LAINE D'AGNEAU

- 26" Lamb's wool duster acts like a magnet to attract dust
- Can be hand washed
- Le plumeau en laine d'agneau qui agit comme un aimant attire la poussière 26 po. • Peut être lavé à la main

LAMBS WOOL DUSTER / PLUMEAU EN LAINE D'AGNEAU

- 44" Telescopic Handle
- Ideal for hard to reach places
- Manche télescopique, 44 po
- Idéal pour les endroits difficilement accessibles

TELESCOPIC MICROFIBER DUSTER / PLUMEAU SOUPLE EN LAINE D'AGNEAU

- 50" Telescopic Handle
- Ideal for hard to reach places



M2 Code Code M2	Description	Pack Wt LB (S) Poids (lb) (S)	Pack Wt KG Poids (kg)	Cubic Ft Pi3	Pack Contenu	List Price Liste des prix
DU-L524	Lambs wool duster - 26" / 66 cm / Plumeau souple en laine d'agneau, 26 po / 66 cm	.25	.1	3	12	\$ 13.88
DU-L524-2	Lambs wool duster - 26" / 66 cm / Plumeau souple en laine d'agneau, 26 po / 66 cm				12	\$ 29.47
DU-L525	Lambs wool duster with 44" / 111 cm telescopic handle - 32" / 81cm Closed / Plumeau en laine d'agneau avec un manche télescopique de 44 po / 111 cm, 32 po / 81cm fermé	42	19.5	5	12	\$ 17.50
DU-L525-2	Telescopic Extra Large Lambs Wool Duster - Ext 44"/111cm - Closed 32"/81cm /				12	\$ 22.40
DU-L527	Telescopic Microfiber Duster - 63" / 160 cm - Closed 41" / 104 cm Dépoussiérage microfibre avec un manche télescopique de - 63"/160 cm - 32 po / 81cm fermé	.25	.1	3	12	\$ 24.29
DU-L528	Lambs Wool duster with Extra Long Flexible Head - Telescopic Handle - Overall Length Closed 55" - Open 74"					\$ 35.37

SUPERIOR OSTRICH FEATHER DUSTER / UN PLUMEAU EN PLUMES D'AUTRUCHE DE QUALITÉ SUPÉRIEURE

Ideal for dusting fine delicate objects, plants and ornaments. They can also be used for cleaning blinds, light fixtures and store shelves.

Idéaux pour dépoussiérer les objets délicats, les plantes et les décorations.

Ils peuvent également être utilisés pour nettoyer les stores, les luminaires et les étagères.



Complete unit / Ensemble complet



Refill

DU-F1224	Superior Ostrich Feather Duster - 26" / 66 cm / Plumeau en plumes d'autruche supérieur - 26 po / 66 cm				12	\$ 22.02
DU-SY4572	Curved Frame Duster complete with Telescopic Handle and Refill / Support de dépoussiérage incurvé avec manche télescopique et recharge	18	8.5	2	12/1	\$ 22.68
DU-SY4573	Curved Frame Duster Refill - Microfiber - Blue / Recharge pour cadre incurvé Microfibre - bleu				12/1	\$ 16.64

OIL TREATED DUST CLOTH / CHIFFON À POUSSIÈRE TRAITÉ À L'HUILE

M2 Dust Cloths are treated with mineral oil to attract and retain dirt and dust particles without leaving lint or residue. The cloth is a magnet for dust and dirt. It will leave surfaces clean without the use of sprays and their costs associated with the addition of chemicals.

Les chiffons anti-poussière M2 sont traités avec de l'huile minérale pour attirer et retenir les particules de saleté et de poussière sans laisser de peluches ou de résidus. Le tissu est un aimant pour la poussière et la saleté. Il va laisser les surfaces propres sans l'utilisation de vaporisateur et leurs coûts associés avec l'ajout de produits chimiques



OIL TREATED DUSTCLOTH / CHIFFON À POUSSIÈRE TRAITÉ À L'HUILE						
FS-9224-YE	Oil Treated Dustcloths - 24" x 24" / 61 x 61 cm - Yellow Chiffon à poussière traité à l'huile - 24" x 24" / 61 x 61 cm - Jaune	Average Wt 15 lbs			50 Bags/ Case 500	\$ 41.85

WASHROOM CARE / ENTRETIEN DES SALLES D'EAU



Available for
Disponible pour
PRIVATE LABEL
ÉTIQUETTE
PRIVÉE

TRIGGER SPRAYERS / PULVÉRISATEUR À GACHETTE



- Nozzle can be adjusted for a fine spray or a jet stream
- Adjustable locking nozzle
- Dip tube filter
- Buse réglable (bruine ou jet continu)
- Buse de blocage réglable
- Tube plongeur avec filtre

M2 Code Code M2	Description	Pack Wt LB (S) Poids (lb) (S)	Pack Wt KG Poids (kg)	Cubic Ft Pi3	Pack Contenu	List Price Liste des prix
TS5911RD	Red & White Trigger Sprayer – 28/400 1.5cc / Pulvérisateur à gâchette rouge et blanc 28/400 1.5 cc	24	11	2.6	350	\$ 2.36
TS5911WH	White & White Trigger Sprayer – 28/400 1.5cc / Pulvérisateur à gâchette blanc et blanc 28/400 1.5 cc	24	11	2.6	420	\$ 2.36
TS5911BL	Blue & White Trigger Sprayer – 28/400 1.5cc / Pulvérisateur à gâchette blue et blanc 28/400 1.5 cc	24	11	2.6	350	\$ 2.36
TS5914GN	Green & White Heavy Duty Trigger Sprayer – 28/400 2.5cc /				300	\$ 3.00



- Ergonomic Sprayer comes complete with remote 36" (90 cm) dip tube
- Ideal for hard to reach areas

- Le pulvérisateur ergonomique comprend un tube plongeur de 36" (90 cm)
- Idéal pour les endroits difficiles à atteindre



M2 Code Code M2	Description	Pack Wt LB (S) Poids (lb) (S)	Pack Wt KG Poids (kg)	Cubic Ft Pi3	Pack Contenu	List Price Liste des prix
TS5930-WH	White & White Standard Trigger Sprayer - On/Off Spray or Mist– 28/400				500	\$ 2.19
TS5932-RD	Red & White Standard Duty Trigger Sprayer - Steam or Mist– 28/400				350	\$ 1.69
TS6019	Chemical Resistant Trigger Sprayer with Viton Rubber O Ring / Gâchette-pulvérisateur résistante aux produits chimiques				200/1	\$ 4.56

SPRAY BOTTLES & JUGS / PULVÉRISATEURS ET BIDONS

**ROUND 16
RONDE 16**



**1L CYLINDER
WHITE /
1L CYLINDRIQUE
BLANCHE**



**ROUND 24
RONDE 24**



**ROUND 32
RONDE 32**



WHMIS / SIMDUT



Imprint on bottle
Étiquette imprimée sur la
bouteille

**CARAFE STYLE
NATURAL /
STYLE CARAFE
NATURELLE**



**CARAFE STYLE
WHITE /
STYLE CARAFE
BLANCHE**



M2 Code Code M2	Description	Pack Wt LB (S) Poids (lb) (S)	Pack Wt KG Poids (kg)	Cubic Ft Pi3	Pack Contenu	List Price Liste des prix
TS-B16	16 oz. Cylindrical bottle 28/400 Neck / Bouteille cylindrique, cou 28/400 - 16 oz	10.6	4.6	6.6	248	\$ 0.94
TS-B2301	1L Cylindrical bottle 28/400 Neck - Natural / 1L Bouteille cylindrique, cou 28/400 - Naturelle				104	\$ 1.30
TS-B2301-WH	1L Cylindrical bottle 28/400 Neck - White / 1L Bouteille cylindrique, cou 28/400 - blanc				104	\$ 1.32
TS-B289-ER	24 oz. Round bottle 28/400 Neck - Natural E /	10.6	4.6	6.6	147	\$ 1.07
TS-B289W-2	24 oz. Round bottle with WHMIS 28/40	10.6	4.6	6.6	147	\$ 1.50
TS-B290-2	32 Oz. Round bottle 28/400 - Natural 2 /	15.8	7.2	6.6	128	\$ 1.46
TS-B290W-2	32 oz. Round bottle with WHMIS 28/400 1L/32 oz	15.8	7.2	6.6	121	\$ 1.92
TS-B2300	32 Oz. Bottle Carafe Style 1L/32oz - 28/400 Neck - Natural / Bouteille style carafe - cou 28/400 - 1L/32oz - naturelle	15	6.8	6.6	104	\$ 1.35
TS-B2300W	32 Oz. Bottle Carafe Style 1L/32oz - 28/400 Neck - White / Bouteille style carafe - cou 28/400 - 1L/32oz - blanc	15	6.8	6.6	104	\$ 1.37



24 OZ



24 OZ



Oz. and ML scale
Graduation en oz/ml

Oz. and ML scale
Graduation en oz/ml

32 OZ



32 OZ



M2 Code Code M2	Description	Pack Wt LB (S) Poids (lb) (S)	Pack Wt KG Poids (kg)	Cubic Ft Pi3	Pack Contenu	List Price Liste des prix
TS-B289W-PL	24 oz. Round bottle with Private Label/ - 28/400 Neck Bouteille ronde - cou 28/400 - 24 oz avec	10.6	4.8	6.6	128/Case	\$ 1.82
TS-B290W-PL	32 oz. Round bottle with Private Label 28/400 Neck/ Bouteille ronde - cou 28/400 - 32 oz avec	15.8	7.2	6.6	128/Case	\$ 2.19
TS-B2300-PL	32 Oz. Bottle Carafe Style Private Label - 1L/32oz 28/400 Neck / Bouteille style carafe - cou 28/400 - 1L/32oz - avec	15	6.8	6.6	104/Case	\$ 2.63

BOTTLE AND TRIGGER SPRAYER COMBOS / BOUTEILLE ET COMBOS PULVÉRISATEUR À GÂCHETTE

TS-BT289-12	24 oz Round Bottle with TS5911R Trigger Sprayer 1.5cc / 24 oz bouteille ronde avec TS5911R pulvérisateur à gâchette 1.5cc				12/Case	\$ 3.24
TS-BT289W-12	24 oz Round Bottle with WHMIS and TS5911R Trigger Sprayer 1.5cc / 24 oz bouteille ronde avec WHMIS et TS5911R pulvérisateur à gâchette 1.5cc				12/Case	\$ 3.80
TS-BT289-12-2	24 oz Round Bottle with TS5930R Trigger Sprayer 1.5cc / 24 oz bouteille ronde avec TS5930R pulvérisateur à gâchette 1.5cc				12/Case	\$ 3.24
TS-BT290-12	32 oz Round Bottle with TS5911R Trigger Sprayer 1.5cc / 32 oz bouteille ronde avec TS5911R pulvérisateur à gâchette 1.5cc				12/Case	\$ 3.25
TS-BT290W-12	32 oz Round Bottle with WHMIS and TS5911R Trigger Sprayer 1.5cc / 32 oz bouteille ronde avec WHMIS et TS5911R pulvérisateur à gâchette 1.5cc				12/Case	\$ 4.19
TS-BT290-12-2	32 oz Round Bottle with TS5930R Trigger Sprayer 1.5cc / 32 oz bouteille ronde avec TS5930R pulvérisateur à gâchette 1.5cc				12/Case	\$ 3.25



BOWL CADDY / SUPPORT À LAVETTE ET BOUTEILLE DE TOILETTE

Ideal for storing bowl brush between cleanings.
Designed to hold a quart size bottle of cleaner and bowl swab.

Idéal pour stocker la brosse de toilette entre les nettoyages. Conçu pour tenir une bouteille d'une pinte de nettoyant et la lavette à toilette



M2 Code Code M2	Description	Pack Wt LB (S) Poids (lb) (S)	Pack Wt KG Poids (kg)	Cubic Ft Pi3	Pack Contenu	List Price Liste des prix
WA-220	Bowl Swab Caddy / Support à lavette et bouteille de toilette	3.85	1.7	1	10/1	\$ 12.96

JUGS / BIDONS



TS-B2400-Bulk	4L Square Jug – 38/400 – Natural -Bulk / Bidon carré, 4L, 38/400, naturel	336	10.5	4.8	.66	336/Skid	\$ 2.12
TS-6000	1 oz Gallon Pump – 38/400-White / Pompe, gallon 1 oz, 38/400 - blanc	24	11	2.6	200/25	\$ 2.83	
TS-6002	1 oz Gallon Pump – 38/400-White / Pompe, gallon 1 oz, 38/400 - blank	24	11	2.6	200/25	\$ 4.95	
TS-6010	2 cc Lotion Pump 28/400 - White	24	11	2.6	1000	\$.71	

CAPS / BOUCHON



TS-B2700	4L US Gal. Big Cap - 38/400 – White / Gros bouchon 4L US - 38/400 - blanc	20	9	1.8	2500/25	\$.17
TS-B2738	4L US Gal. Cap – White 38/400 B/Liner /	20	9	1.8	3200/25	\$.24
TS-B2700-V	4L US Gal. Cap – White 38/400 Big Cap with Vented Liner	20	9	1.8	2500/25	\$ 2.27
TS-B2701	Small Cap - 28/400 – White / Petit bouchon - 28/400 - blanc	20	9	1.8	4675/25	\$.17
TS-B2710	Child Resistant Cap - 28/400 – White - Lined / Bouchon résistant aux enfants - 28/400 - blanc - Doublé	20	9	1.2	1700/25	\$.45
TS-B2711	Child Resistant Cap - 38/400 – White - Lined / Bouchon résistant aux enfants - 38/400 - blanc - Doublé	20	9	1.2	950/25	\$.48
TS-B2720	Dispensing Lock Top for 1 L Caraf and 16 oz Bottle Only - 28/400 – White / Distribution à verrou pour 1 L Caraf et 16 oz Bouteille Seulement - 28/400 - blanc	20	9	1.2	1800/25	\$.90
TS-B2721	Dispensing Flip Cap – Ketchup Style - 28/400 – White / Bouchon articulé - Style Ketchup - 28/400 - blanc	20	9	1.2	3500/25	\$.43
TS-PP6000	12 x 1L Pump Up Sprayer				15	\$ 14.45
TS-PP6000	Pump up Sprayer / Vaporisateur à pompe - 600mL	12.5	5.7	2.4	15	\$ 12.26

WASHROOM CARE / POUR LA SALLE DE BAIN

Two (2) "D" Size batteries required - Not included / Deux batteries "D" requises, non incluses

AIR-MIST DISPENSER

- Air-Mist dispenser has a smooth design can be adjusted for different spray times
- Easy to install

DISTRIBUTEUR D'ODEUR AUTOMATIQUE

- Le distributeur Air-Mist est de conception lisse et peut être ajusté pour différents temps de pulvérisation.
- Facile à installer



M2 Code Code M2	Description	Pack Wt LB (S) Poids (lb) (S)	Pack Wt KG Poids (kg)	Cubic Ft Pi3	Pack Contenu	List Price Liste des prix
WA-AR500	Air-Mist Dispenser / Distributeur d'odeur automatique	1	.5		40/1	\$ 56.68
WA-AR501	Air-Mist Dispenser Refill – Fruity Citrus / Recharge distributeur d'odeur automatique d'air - Fruité/Citron	8	3.6		12	\$ 7.51
WA-AR502	Air-Mist Dispenser Refill – Apple / Recharge distributeur d'odeur automatique d'air - Pomme	8	3.6		12	\$ 7.51
WA-AR503	Air-Mist Dispenser Refill – Cherry/Berry / Recharge distributeur d'odeur automatique d'air - Cerise / Baie	8	3.6		12	\$ 7.51
WA-AR504	Air-Mist Dispenser Refill – Lemon/Lime / Recharge distributeur d'odeur automatique d'air - Citron / Citron vert	8	3.6		12	\$ 7.51
WA-AR505	Air-Mist Dispenser Refill – Baby Fresh / Recharge distributeur d'odeur automatique d'air - Bébé frais	8	3.6		12	\$ 7.51
WA-AR506	Air-Mist Dispenser Refill – Ocean Morning / Recharge distributeur d'odeur automatique d'air - Ocean Matin	8	3.6		12	\$ 7.51
WA-AR507	Air-Mist Dispenser Refill – Fresh Linen / Recharge distributeur d'odeur automatique d'air –air mist linge frais	8	3.6		12	\$ 7.51
WA-AR508	Air Mist Dispenser Refill - Mango - Recharge distributeur d'odeur d'air - Mango	8	3.6		12	\$ 7.51

AEROSOL CLEANERS / NETTOYANTS EN AÉROSOL



M2 Code Code M2	Description	Pack Wt LB (S) Poids (lb) (S)	Pack Wt KG Poids (kg)	Cubic Ft Pi3	Pack Contenu	List Price Liste des prix
AR-GL9200	Glass Cleaner/ Nettoyant à Vitres - 500 g				12	\$ 17.06
AR-FU9202	Furniture Polish - Lemon/ Poli à Meubles - limon -496 g				12	\$ 23.41
AR-ST9203	Stainless Steel/ Nettoyant Pour Acier Inoxydable - 397 g				12	\$ 26.18
AR-AP9204	All Purpose Cleaner/Nettoyant à Tout Usage - 539 g				12	\$ 17.79
AR-OV9205	Grill & Oven Cleaner/Nettoyant pour grilles et four - 510 g				12	\$ 21.51
AR-OA9206	Orange Attack Odour Neutralizer / Neutralisateur d'odeur – Attaque d'orange - 369 g				12	\$ 36.55



**FOAM SOAP DISPENSE
DISTRIBUTEUR DE SAVON-MOUSSE
1000ML/33OZ**

- Used for soap/sanitizer/shower gel
- Wall mounted
- Includes Foam Tape and Screws
- Keyless but lockable
- Utilisé pour savon, désinfectant ou gel douche
- Incluant mousse, ruban adhésif et vis, sans clé mais verrouillable



**LOTION SOAP DISPENSE
DISTRIBUTEUR DE SAVON EN LOTION
1000ML/33OZ**

- Wall mounted
- Includes Foam Tape and Screws
- Keyless but lockable
- Utilisé pour savon, désinfectant ou gel douche
- Incluant mousse, ruban adhésif et vis, sans clé mais verrouillable

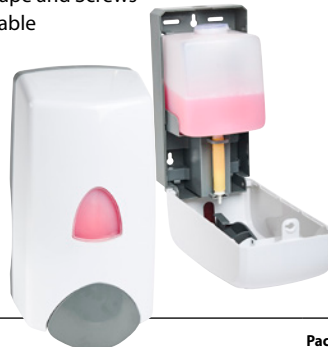

**MANUAL LOTION SOAP DISPENSER
"CLEARVIEW"
DISTRIBUTEUR DE SAVON EN LOTION
MANUEL "CLEARVIEW"
1000ML/33OZ**

- Used for Liquid Sanitizer, Liquid Soap, Liquid Shower Gel and Alcohol
- Utilisé pour les désinfectant liquide, le savon liquide, le gel douche liquide et l'alcool



M2 Code Code M2	Description	Pack Wt LB (S) Poids (lb) (S)	Pack Wt KG Poids (kg)	Cubic Ft Pi3	Pack Contenu	List Price Liste des prix
WA-SD710	Foam Soap Dispenser 1000ml/33oz – Large-White / Distributeur de savon-mousse 1000ml/33 oz. Ensemble mural blanc				24/1	\$ 41.26
WA-SD711	Lotion Soap Dispenser 1000ml/33oz – Large-White / Distributeur de savon en lotion 1000 ml/33 oz. Ensemble mural blanc				24/1	\$ 41.26
WA-SD712	Manual Lotion Soap Dispenser – ClearView 1000ml/33oz / Distributeur de savon en lotion manuel "Clear view" 1000 ml/33 oz.				30/1	\$ 37.72

TOUCHLESS LIQUID DISPENSER - 1000/32 OZ

Touchless - No Longer need to touch Liquid Soap Dispenser – just position hand under the sensor and the infrared sensor will automatically dispense soap, sanitizer, disinfectant or any other liquids of your choice.



**TOUCHLESS FOAM/SOAP DISPENSER
1000/33 OZ**

Touchless - No Longer need to touch Foam Dispenser – just position hand under the sensor and the infrared sensor will automatically dispense soap, sanitizer, disinfectant or any other low viscosity liquids of your choice.



Battery Compartment
(6 AA Batteries not included)

HAND SANITIZER STATION

- Dispenser Stands
- Constructed of durable stainless steel
- Adjustable from 48"/122cm to 66"/167cm
- Easy-to-clean drip tray
- Extra long mounting surface



WA-SD962-L	Touchless Liquid Dispenser - Large - 1000ml/33oz - White -Wall Mounted - Including Foam Tape & Screws. Keyless but lockable. AA Battery. 1,2,3 Drops for Settin - Use with Alcohol Gel, Sanitizer, Disinfectant or Hand Soap				12/1	\$ 106.66
WA-SD963-F	Touchless Foam Dispenser - Large - 1000ml/33oz - White Wall Mounted - Including Foam Tape & Screws. Keyless but lockable. AA Battery. 1,2,3 Drops for Setting - Use with Alcohol Gel, Sanitizer, Disinfectant or Hand Soap				12/1	\$ 106.66
WA-SDS1	Display Stand Only - Maximum Height 66 inches / 1.5 meters				2/1	\$ 207.70

**BOWL BRUSH WIRE CENTRE /
BROSSE À CUVETTES AVEC BROCHE TORSADÉE**

- Ergonomically designed handle for superior scrubbing power
- Manche ergonomique, grand pouvoir nettoyant



15.5" /40 cm

**BOWL & CADDY /
BROSSE À CUVETTES ET PORTE-BROSSE**

- Caddy for easy storage
- Ideal for superior scrubbing power
- Porte-brosse pour rangement facile
- Grand pouvoir nettoyant

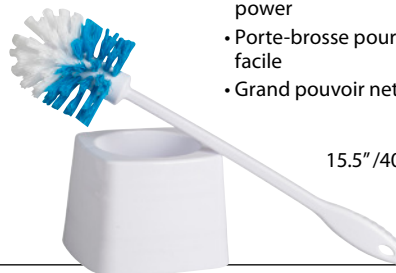

15.5" /40 cm

**BOWL BRUSH /
BROSSE À CUVETTES**

- Ergonomically designed handle
- Superior scrubbing power
- Manche ergonomique
- Grand pouvoir nettoyant



15.5" /40 cm

BR-WM202	Bowl Brush with Twisted Wire Centre – Poly Pro Bristles / Brosse à cuvettes avec broche torsadée, fibres de polypropylène	3.5	1.5	1	12	\$ 5.26
BR-WM203	Bowl Brush with Caddy – Poly Pro Bristles / Brosse à cuvettes avec porte-brosse, fibres de polypropylène	8	4	1.6	24	\$ 7.96
BR-WM203-C	Bowl Brush Caddy / Panier à brosses				24	\$ 4.89
BR-WM204	Bowl Brush Only – Poly Pro Bristles / Brosse à cuvettes seulement, fibres de polypropylène	2	1	.4	24	\$ 5.26

**ACRYLIC BOWL SWAB /
LAVETTE À CUVETTES ACRYLIQUE**

- Economical acid resistant bowl swab attached to a strong handle
- Lavette à cuvettes économique, résistante à l'acide fixée et munie d'un manche robuste
- Fibres synthétiques à séchage rapide, ne goutte pas



**BOWL SWAB WITH CUP /
LAVETTE À CUVETTES ET PORTE-LAVETTE**

- Economical acid resistant bowl swab attached to a strong handle
- Lavette à cuvettes économique et résistante à l'acide fixée à un manche robuste
- Le cône mobile essore la lavette pour en éliminer l'excès de liquide.



**HD BOWL BRUSH WITH WIRE CENTRE /
BROSSE À CUVETTES RÉSISTANTE AVEC
BROCHE TORSADÉE**



M2 Code Code M2	Description	Pack Wt LB (S) Poids (lb) (S)	Pack Wt KG Poids (kg)	Cubic Ft Pi3	Pack Contenu	List Price Liste des prix
WA-209	Acrylic bowl swab / Lavette à cuvettes acrylique	11	5	1.2	100	\$ 1.70
WA-210	Acrylic bowl swab with cup / Lavette à cuvettes acrylique et porte-lavette	15.5	7	1.6	100/10	\$ 2.98
BR-WM214	HD Bowl Brush with Wire Centre / Brosse à cuvettes résistante avec broche torsadée				12	\$ 10.77



RT-TB-9310	Toilet Brush Only / Brosse à cuvette seulement				24	\$ 6.69
RT-TB-9311	Toilet Brush and Cup / Brosse à cuvette seulement				12	\$ 7.58
RT-TB-9313	Toilet Wire Brush / Brosse à cuvette torsadée				12	\$ 5.38
RT-TB-9314	Toilet Brush Only/ Brosse à cuvette seulement				12	\$ 6.50
RT-TB-9315	Toilet Brush with Lip and Cup/ Brosse à toilette avec brosse contour				12	\$ 9.55

**HEAVY DUTY PLUNGER /
SIPHON RÉSISTANT**



WA2026

**DELUXE PLUNGER /
SIPHON DELUXE**

- Ergonomically designed handle with a rubber cup that fits most drains and toilets
- Caddy to store plunger
- Manche ergonomique avec un capuchon en caoutchouc qui s'adapte à la plupart des cuvettes
- Porte-siphon



WA2025



WA-2025	Deluxe Plunger with Plastic Handle / Siphon Deluxe	6	3	2	32/6	\$ 11.52
WA-2026	Heavy Duty Plunger with 16" / 40 cm Wood Handle / Siphon résistant – 16 po / 40 cm	7.3	3.3		48/12	\$ 7.35
RT-WW-9312	Window Wiper / Essuie-glace				48	\$ 3.43
RT-PL-9326	Plunger / Brosse à cuvette avec côté				6	\$ 5.15

URINAL SCREEN / TAMIS D'URINOIR

Wave screens last longer and stop urine splashback eliminating urine on floors /
Tamis désodorisant "wave" durent plus longtemps et empêchent l'éclaboussure et le dépôt de l'urine sur le plancher



M2 Code Code M2	Description	Pack Wt LB (S) Poids (lb) (S)	Pack Wt KG Poids (kg)	Cubic Ft Pi3	Pack Contenu	List Price Liste des prix
WA-US30	Wave Urinal Screen – Spiced Apple / Tamis désodorisant "Wave" - Pomme épicée				12	\$ 5.59
WA-US31	Wave Urinal Screen – Fruit Basket / Tamis désodorisant "Wave" - Panier de fruits				12	\$ 5.59
WA-US32	Wave Urinal Screen – Lemon Lime / Tamis désodorisant "Wave" - Citron lime				12	\$ 5.59
WA-US33	Wave Urinal Screen – Ocean Breeze / Tamis désodorisant "Wave" - Brise d'océan				12	\$ 5.59

URINAL SCREEN / TAMIS D'URINOIR

SCREEN WITH PUCK

- Disposable urinal screen with block
- Long lasting – Cleans and descales with every flush
- Para-Benzene free

TAMIS DÉSORODISANT AVEC BLOC

- Tamis d'urinoir avec bloc jetable
- Longue durée, nettoie et détartré à chaque chasse d'eau
- Sans paradichlorobenzène



WA-US19	Urinal Screen with Puck – Baby Fresh / Tamis désodorisant avec bloc, Bébé frais	3.7	1.7	.4	12	\$ 4.48
WA-US20	Urinal Screen with Puck – Lavender / Tamis désodorisant avec bloc, lavande	3.3	1.5	.3	12	\$ 4.47
WA-US21	Urinal Screen with Puck – Green Apple / Tamis désodorisant avec bloc, pomme verte	3.3	1.5	.3	12	\$ 4.47
WA-US22	Urinal Screen with Puck – Cherry / Tamis désodorisant avec bloc, cerise	3.3	1.5	.3	12	\$ 4.47
WA-US23	Urinal Screen with Puck – Pot Pourrie - Teal / Tamis désodorisant avec bloc, pot-pourri - bleu sarcelle	3.3	1.5	.3	12	\$ 4.47
WA-US24	Urinal Screen with Puck – Fresh Linen - Blue / Tamis désodorisant avec bloc, linge frais - bleu	3.3	1.5	.3	12	\$ 4.47
WA-PU0003	3oz Dichlorobenzene urinal puck, White - Cherry / Tamis désodorisant – dichlorobenzène 3oz - blanc - cerise				144/12	\$ 2.57
WA-PU0016	16oz Dichlorobenzene urinal Block, White - Cherry / Tamis désodorisant – dichlorobenzène 16oz - blanc - cerise				12	\$ 16.26

FLAT SCREEN DEODORIZERS

- Traditional flat screen helps prevent debris from clogging pipes
- Long lasting fragrance

TAMIS PLÂT DÉSORODISANT

- Tamis plat classique empêchant les débris de boucher les tuyaux
- Parfum longue durée

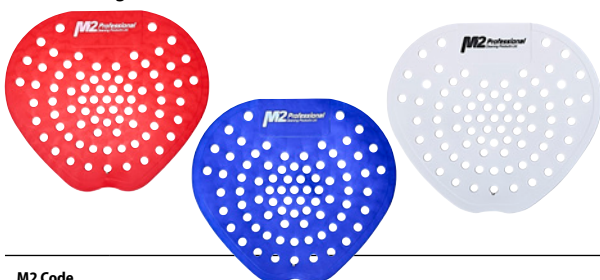

URINAL Z-MAT / TAPIS D'URINOIR Z-MAT

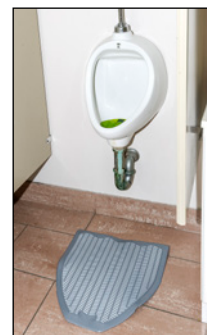
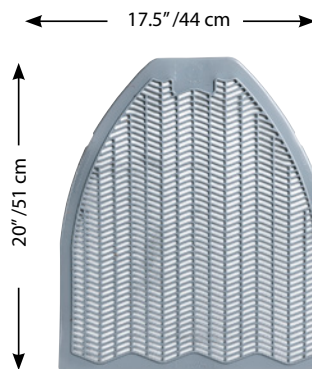

- The Z-Mat gives a Fresh Blast of fragrance to any washroom with urinals.
- It help protect floors from stains and uric acid damage.
- Le tapis Z-Mat donne une nouvelle rafale de parfum à une salle d'eau avec urinoir
- Il aide à protéger les planchers contre les taches et les dommages de l'acide urique

M2 Code Code M2	Description	Pack Wt LB (S) Poids (lb) (S)	Pack Wt KG Poids (kg)	Cubic Ft Pi3	Pack Contenu	List Price Liste des prix
WA-US1	Urinal Screen – Cherry / Tamis désodorisant, cerise	1.5	3.3		12	\$ 2.33
WA-US2	Urinal Screen – Bubble Gum / Tamis désodorisant, Bubble gum	1.5	3.3		12	\$ 2.33
WA-US3	Urinal Screen – No Scent - White Tamis désodorisant, Pas de parfum Blanc	1.5	3.3		12	\$ 2.95
ZM-1526	Z-Mat Toilet Mat / Z-Mat Tapis d'urinoir				6/1	\$ 26.87

INDOOR/OUTDOOR ACCESSORIES / ACCESSOIRES INTÉRIEURS/EXTÉRIEURS



PAPER DISPENSER / DISTRIBUTEUR DE PAPIER

Universal paper towel dispenser will accept all standard single fold and roll towels (max. 6" diameter and up to 10" long). Front loading for easy service and maintenance. All welded construction of 20 and 22 gauge steel. Full length piano hinge on door.

Le distributeur universel de serviettes de papier acceptera tous les serviettes pliées séparément ou en rouleau (max. 6" diam. et jusqu'à 10" long.). Le remplissage par l'avant facilite le service et la maintenance. Entièrement construit de métal soudé de calibre 20 et 22. Peinture de piano pleine longueur sur la porte.

WIDTH INCHES: 10-1/2 (26.67 cm)
DEPTH INCHES: 6-3/4 (17.15 cm)
HEIGHT INCHES: 9-1/2 (24.13 cm)

LARGEUR 10 1/2" (26.67 cm)
PROFONDEUR 6 3/4" (17.15 cm)
HAUTEUR 9 1/2" (24.13 cm)

M2 Code Code M2	Description	Pack Wt LB (S) Poids (lb) (S)	Pack Wt KG Poids (kg)	Cubic Ft Pi3	Pack Contenu	List Price Liste des prix
WA-P101	Dual Paper Towel Dispenser / Distributeur De Papier Essuie-Tout	3.8	1.7		6/1	\$ 54.71

TOILET DISPENSERS / DISTRIBUTEUR DE PAPIER HYGIÉNIQUE



Ideal for areas requiring a heavy duty economical dispenser. Tension springs restrict paper consumption to prevent free wheeling of roll. Front loading for easy service and maintenance. All surfaces finished in polished chrome.

Idéal pour les espace qui requiert un distributeur robuste et économique. Un ressort sous tension restreint la consommation du papier pour prévenir le déroulement excessif. Remplissage par l'avant pour faciliter le service et la maintenance. Toutes les surfaces sont finis en chrome poli.

M2 Code Code M2	Description	Pack Wt LB (S) Poids (lb) (S)	Pack Wt KG Poids (kg)	Cubic Ft Pi3	Pack Contenu	List Price Liste des prix
WA-T146	Single Roll, Toilet Dispenser / Distributeur de papier hygiénique, Simple	11.88	5.4	1.5	20/1	\$ 17.54
WA-T150	Double Roll, Toilet Dispensere / Distributeur de papier hygiénique, Double	24.12	10.12	1.48	10/1	\$ 29.74

STAND UP & OUTDOOR ASHTRAYS / CENDRIERS SUR PIED ET D'EXTÉRIEUR



M2 Code Code M2	Description	Pack Wt LB (S) Poids (lb) (S)	Pack Wt KG Poids (kg)	Cubic Ft Pi3	Pack Contenu	List Price Liste des prix
OD-A909	Outdoor AshTray - 7.5" x 4.7" x 9.5" / 19 x 12 x 24 cm / Cendrier extérieur en acier inoxydable - 7.5 x 4.7 x 9.5 po / 19 x 12 x 24 cm	12.5	5.6	1.14	4/1	\$ 101.21



Q-STAR MICROFIBRE CLOTH / LINGE MICROFIBRE Q-STAR

Features

- Quick and easy handling due to low friction
- Streak free and low linting
- Chemical resistant against disinfectants etc.
- Damp and dry cleaning versatility
- Washable at 95°C / 203°F
- Ideal for computers, hospitals, automotive office and much more

Caractéristiques

- Utilisation facile et rapide grâce à une faible friction
- Pas de traces, peu de peluches
- Résistance chimique aux désinfectants, etc.
- Nettoyage à sec ou humide
- Lavable à 95°C / 203°F
- Idéale pour nettoyer les ordinateurs, les hôpitaux, les voitures, le bureau, etc.



M2 Code Code M2	Description	Pack Wt LB (S) Poids (lb) (S)	Pack Wt KG Poids (kg)	Cubic Ft Pi3	Pack Contenu	List Price Liste des prix
QM-7580	Q-Star Microfiber Cloth – 16"x16"/40 x 40 cm - Blue / Linge microfibre Q-Star - 16"x16"/40 x 40 cm - bleu				12/Bag	\$ 3.56
QM-7581	Q-Star Microfiber Cloth – 16"x16"/40 x 40 cm - Red / Linge microfibre Q-Star - 16"x16"/40 x 40 cm - rouge				12/Bag	\$ 3.56
QM-7582	Q-Star Microfiber Cloth – 16"x16"/40 x 40 cm - Yellow / Linge microfibre Q-Star - 16"x16"/40 x 40 cm - jaune				12/Bag	\$ 3.56
QM-7583	Q-Star Microfiber Cloth – 16"x16"/40 x 40 cm - Green / Linge microfibre Q-Star - 16"x16"/40 x 40 cm - vert				12/Bag	\$ 3.56
Q-STAR MICROFIBRE CLOTH 2 Pack / LINGE MICROFIBRE Q-STAR Paquet de 2						
QM-7680	Q-Star Microfiber Cloth – 16"x16"/40 x 40 cm - Blue - 2 Bag / Linge microfibre Q-Star - 16"x16"/40 x 40 cm - bleu - Paquet de 2				2	\$ 7.12
QM-7681	Q-Star Microfiber Cloth – 16"x16"/40 x 40 cm - Red - 2 Bag / Linge microfibre Q-Star - 16"x16"/40 x 40 cm - rouge - Paquet de 2				2	\$ 7.12
QM-7682	Q-Star Microfiber Cloth – 16"x16"/40 x 40 cm - Yellow - 2 Bag / Linge microfibre Q-Star - 16"x16"/40 x 40 cm - jaune - Paquet de 2				2	\$ 7.12
QM-7683	Q-Star Microfiber Cloth – 16"x16"/40 x 40 cm - Green - 2 Bag / Linge microfibre Q-Star - 16"x16"/40 x 40 cm - vert - Paquet de 2				2	\$ 7.12

SILVERCLOTH & NANOSILVER MICROFIBER PADS IDEAL FOR HEALTHCARE & HOSPITAL USE / CHIFFON EN TISSU D'ARGENT & CHIFFONS EN MICROFIBRE D'ARGENT NANO TECHNOLOGIQUE IDÉAL POUR LES SOINS DE SANTÉ ET HOSPITALIERS



SLC-13161	SilverCloth 12"x 15"-30cm X 38 cm – Blue / Chiffon en tissu d'argent 12 po x 15 po / 30 x 38 cm, bleu				5 Pack 20 Bags	\$ 8.37
SLC-13163	SilverCloth 12"x 15"-30cm X 38 cm – Green / Chiffon en tissu d'argent 12 po x 15 po / 30 x 38 cm, jaune				5 Pack 20 Bags	\$ 8.37
MFP-5010-BL	NanoSilver MicroPad 10"/25 cm WetPad -Blue/Blue / Tampon humide microfibre "NanoSilver" bleu/bleu 12"/25 cm				6	\$ 18.80
MFP-5012-BL	NanoSilver MicroPad 12"/30 cm WetPad -Blue/Blue / Tampon humide microfibre "NanoSilver" bleu/bleu 12"/30 cm				6	\$ 19.98
MFP-5018-BL	NanoSilver MicroPad 18"/45 cm WetPad -Blue/Blue / Tampon humide microfibre "NanoSilver" bleu/bleu 18"/45 cm				6	\$ 22.34
MFP-5018-GN	NanoSilver MicroPad 18"/45 cm WetPad -Blue/Green / Tampon humide microfibre "NanoSilver" bleu/vert 18"/45 cm				6	\$ 22.34
MFP-5018-RD	NanoSilver MicroPad 18"/45 cm WetPad -Blue/Red / Tampon humide microfibre "NanoSilver" bleu/rouge 18"/45 cm				6	\$ 22.34
MFP-6018-GY	NanoSilver MicroScrub 18"/45 cm Wet Pad Non Slip -Blue/Grey/ Tampon humide MicroScrub microfibre "NanoSilver" bleu/gris 18"/45 cm				6	\$ 23.87

MICRO WIPING / CHIFFONS - MICROFIBRE

- Blue** – All purpose low risk – used for cleaning common areas, ledges and general cleaning areas
Can also be used for dusting and cleaning windows in lower risk areas
- Green** – Food/Kitchen – used for cleaning in kitchen food prep areas, bars or anywhere food is prepared
- Red** – High risk – used in areas for cleaning toilets and restrooms where there is more risk of infections and cross-contamination
- Yellow** – Medium risk – used for cleaning sinks washbasins, tiles and window ledges

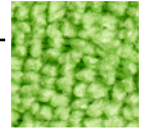

Close-up of MicroCloth fibre
Gros-plan d'un chiffon microfibre

- bleu** - Tout usage à faible risque - pour les aires communes, les rebords des fenêtres et les zones de nettoyage général
Sert également à l'époussetage et au nettoyage des fenêtres dans les aires à faible risque
- vert** - Aliments / cuisine - pour les surfaces de préparation des aliments, les bars
- rouge** - Risque élevé - pour les toilettes, les urinoirs, c'est-à-dire les endroits où les risques d'infection et de contamination croisée sont élevés
- jaune** - Risque moyen - pour les évier, les carreaux et les rebords des fenêtres

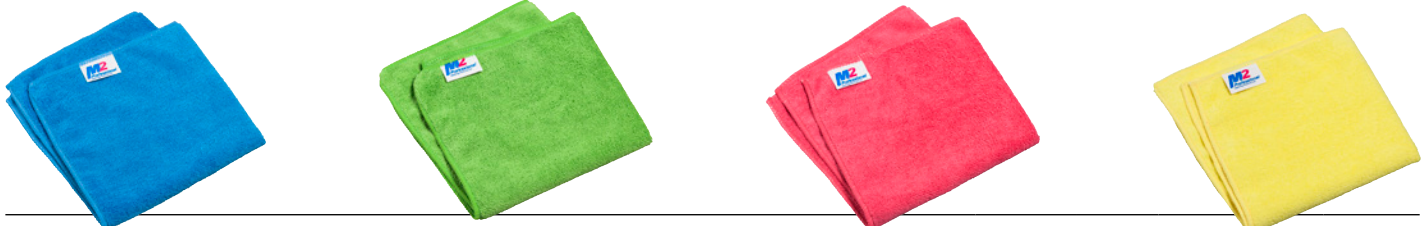

M2 Code Code M2	Description	Pack Wt LB (S) Poids (lb) (S)	Pack Wt KG Poids (kg)	Cubic Ft Pi3	Pack Contenu	List Price Liste des prix
WOVEN MICROFIBER CLOTH / CHIFFON MICROFIBRE TISSÉ EN VRAC - 300 GSM - 120 Master Case						
MC-500-BL	Sani-Pro MicroCloth – All Purpose 16"x16"/40 x 40 cm – Blue / Sani-Pro Chiffon microfibre, 16 po x 16 po / 40 x 40 cm, bleu			1.4	10 Bag/12	\$ 3.04
MC-501-GN	Sani-Pro MicroCloth – Food/Kitchen/Common Areas 16"x16"/40 x 40 cm – Green / Sani-Pro Chiffon microfibre, 16 po x 16 po / 40 x 40 cm, verte			1.4	10 Bag/12	\$ 3.04
MC-502-RD	Sani-Pro MicroCloth – Toilets/Bathrooms 16"x16"/40 x 40 cm – Red / Sani-Pro Chiffon microfibre, 16 po x 16 po / 40 x 40 cm, rouge			1.4	10 Bag/12	\$ 3.04
MC-503-YE	Sani-Pro MicroCloth – Bath Tile/Walls 16"x16"/40 x 40 cm – Yellow / Sani-Pro Chiffon microfibre, 16 po x 16 po / 40 x 40 cm, jaune			1.4	10 Bag/12	\$ 3.04
MC-504-OR	Sani-Pro MicroCloth – Bath Tile/Walls 16"x16"/40 x 40 cm –Orange/ Sani-Pro Chiffon microfibre, 16 po x 16 po / 40 x 40 cm, orange			1.4	10 Bag/12	\$ 3.04
2 PACK - WOVEN MICROFIBER CLOTH / CHIFFON MICROFIBRE TISSÉ EN VRAC - 300 GSM - 120 Master Case						
MC-520-BL	Sani-Pro MicroCloth – All Purpose 16"x16"/40 x 40 cm – Blue / Sani-Pro Chiffon microfibre, 16 po x 16 po / 40 x 40 cm, bleu			1.4	2/Bag	\$ 6.08
MC-521-GN	Sani-Pro MicroCloth – Food/Kitchen/Common Areas 16"x16"/40 x 40 cm – Green / Sani-Pro Chiffon microfibre, 16 po x 16 po / 40 x 40 cm, verte			1.4	2/Bag	\$ 6.08
MC-522-RD	Sani-Pro MicroCloth – Toilets/Bathrooms 16"x16"/40 x 40 cm – Red / Sani-Pro Chiffon microfibre, 16 po x 16 po / 40 x 40 cm, rouge			1.4	2/Bag	\$ 6.08
MC-523-YE	Sani-Pro MicroCloth – Bath Tile/Walls 16"x16"/40 x 40 cm – Yellow / Sani-Pro Chiffon microfibre, 16 po x 16 po / 40 x 40 cm, jaune			1.4	2/Bag	\$ 6.08
ECONOMY WOVEN MICROFIBER CLOTH / CHIFFON MICROFIBRE TISSÉ EN VRAC - 280 GSM - 120 Master Case						
MC-600-BL	MicroCloth – All Purpose 14"x14"/35 x 35 cm – Blue / Chiffon microfibre, 14"x14"/35 x 35 cm , bleu			1.4	12	\$ 1.65
MC-601-GN	MicroCloth – Food/Kitchen/Common Areas 14"x14"/35 x 35 cm – Green / Chiffon microfibre, 14"x14"/35 x 35 cm , verte			1.4	12	\$ 1.65
MC-602-RD	MicroCloth – Toilets/Bathrooms 14"x14"/35 x 35 cm – Red / Chiffon microfibre, 14"x14"/35 x 35 cm , rouge			1.4	12	\$ 1.65
MC-603-YE	MicroCloth – Bath Tile/Walls 14"x14"/35 x 35 cm – Yellow / Chiffon microfibre, 14"x14"/35 x 35 cm , jaune			1.4	12	\$ 1.65
ECONOMY WOVEN MICROFIBER CLOTH / CHIFFON MICROFIBRE TISSÉ EN VRAC - 280 GSM - 120 Master Case						
MC-620-BL	MicroCloth – All Purpose 14"x14"/35 x 35 cm – Blue / Chiffon microfibre, 14"x14"/35 x 35 cm , bleu			1.4	2/12	\$ 3.30
MC-621-GN	MicroCloth – Food/Kitchen/Common Areas 14"x14"/35 x 35 cm – Green / Chiffon microfibre, 14"x14"/35 x 35 cm , verte			1.4	2/12	\$ 3.30
MC-622-RD	MicroCloth – Toilets/Bathrooms 14"x14"/35 x 35 cm – Red / Chiffon microfibre, 14"x14"/35 x 35 cm , rouge			1.4	2/12	\$ 3.30
MC-623-YE	MicroCloth – Bath Tile/Walls 14"x14"/35 x 35 cm – Yellow / Chiffon microfibre, 14"x14"/35 x 35 cm , jaune			1.4	2/12	\$ 3.30



WOVEN MICROFIBER CLOTH / CHIFFON MICROFIBRE TISSÉ EN VRAC - 240 GSM - 120 Master Case						
MC-580-BL	Sani-Pro MicroCloth – All Purpose 16"x16"/40 x 40 cm – Blue / Sani-Pro Chiffon microfibre, 16 po x 16 po / 40 x 40 cm, bleu			1.4	12	\$ 1.47
MC-581-GN	Sani-Pro MicroCloth – Food/Kitchen/Common Areas 16"x16"/40 x 40 cm – Green / Sani-Pro Chiffon microfibre, 16 po x 16 po / 40 x 40 cm, verte			1.4	12	\$ 1.47
MC-582-RD	Sani-Pro MicroCloth – Toilets/Bathrooms 16"x16"/40 x 40 cm – Red / Sani-Pro Chiffon microfibre, 16 po x 16 po / 40 x 40 cm, rouge			1.4	12	\$ 1.47
MC-583-YE	Sani-Pro MicroCloth – Bath Tile/Walls 16"x16"/40 x 40 cm – Yellow / Sani-Pro Chiffon microfibre, 16 po x 16 po / 40 x 40 cm, jaune			1.4	12	\$ 1.47
WINDOW MICROCLOTH / CHIFFON MICROFIBRE POUR VITRES						
MC-700	Window MicroCloth 14"x14"/35 x 35 cm / Chiffon microfibre pour vitres, 14 po x 14 po / 35 x 35 cm				12	\$ 2.14



ALL PURPOSE SPONGE CLOTH USED IN A VARIETY OF CLEANING ENVIRONMENTS. CHIFFON ÉPONGE A TOUT USAGE UTILISÉ DANS UNE VARIÉTÉ DE ENVIRONNEMENTS DE NETTOYAGE.

5 Pack
12" x 10" /
31.5 x 25.7 cm

Rinse the M2 All Purpose Sponge Cloth before the first use and squeeze out all the excess water.

It can be used with the most customary detergents. Do not use detergents with acids or oxidizing agents (e.g. bleach).

To meet the HACCP requirements, please use the our All Purpose Sponge Cloth for one application only..

After usage it can be washed in the washing machine or dishwasher (up to 200°F / 95°C) and you use it again.

Rincez le tissu M2 Chiffon Éponge a Tout Usage avant la première utilisation et essorez tout l'excès d'eau.

Il peut être utilisé avec les détergents les plus courants. Ne pas utiliser de détergents avec des acides ou des agents oxydants (par exemple l'eau de Javel).

Pour répondre aux exigences HACCP, veuillez utiliser notre tissu M2 Chiffon Éponge a Tout Usage pour une seule application. Après utilisation, il peut être lavé dans la machine à laver ou au lave-vaisselle (jusqu'à 200° F / 95° C) et vous l'utilisez à nouveau.

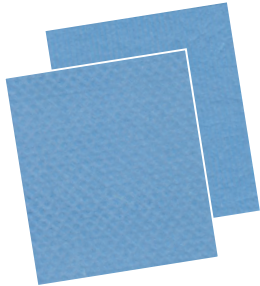

**Industrial Cleaning /
Nettoyage industriel**
OFFICE • HOTELS • SCHOOLS
BUREAU • HÔTELS • ÉCOLES

**Healthcare /
Services sanitaires**
HOSPITALS • RESTROOMS
HÔPITAUX • TOILETTES

**Food Service /
Service alimentaire**
RESTAURANT • FAST FOOD
RESTAURANT • FAST FOOD

**Office & Equipment /
Bureau et équipement**
COMPUTER • ORDINATEURS
TELEVISIONS • TÉLÉVISIONS

Elevators
Windows & Doors
Stairways
Furniture
Equipment

Ascenseurs
Portes et Fenêtres
Escaliers
Meubles
Équipement

Washrooms
Sinks
Tiles
Technical Equipment
Laundry Rooms

Toilettes
Éviers
Carrelage
Équipement Technique
Laverie Chambres

Glasswear
Dishes
Ovens
Tables & Counters
Kitchen Equipment

Verrerie
Vaisselle
Fours
Table et compteurs
Equipements de Cuisine

Computer Desks
Electronics
Technical Equipment
Monitors

Ordinateurs
Bureaux
Électronique
Équipement Technique
Moniteurs

SPGC-12101	SPG All Purpose Cloth – 12"x10"/31.5 x 25.5 cm - Blue / SPG Chiffon a tout usage – 12"x10"/31.5 x 25.5 cm - bleu	20 Pack 5 Each/Bag	\$ 4.43
SPGC-12102	SPG All Purpose Cloth – 12"x10"/31.5 x 25.5 cm - Red / SPG Chiffon a tout usage – 12"x10"/31.5 x 25.5 cm - rouge	20 Pack 5 Each/Bag	\$ 4.43
SPGC-12103	SPG All Purpose Cloth – 12"x10"/31.5 x 25.5 cm - Green / SPG Chiffon a tout usage – 12"x10"/31.5 x 25.5 cm - vert	20 Pack 5 Each/Bag	\$ 4.43
SPGC-12104	SPG All Purpose Cloth – 12"x10"/31.5 x 25.5 cm - Yellow / SPG Chiffon a tout usage – 12"x10"/31.5 x 25.5 cm - jaune	20 Pack 5 Each/ Bag	\$ 4.43

Q-STAR MICROROLL

DISPOSABLE MICROFIBER WIPES



FEATURES

- 99.9% Removal of bacteria
- Low linting streak free cleaning
- High tear resistance
- Damp and dry cleaning versatility
- Ideal for hospitals, foodservice, cleanrooms, computers, office and more



CARACTÉRISTIQUES

- Élimination des bactéries à 99.9%
- Faible peluchage, nettoyage sans trainée
- Haute résistance à la déchirure
- Polyvalence de nettoyage, humide ou sec
- Idéal pour le nettoyage des hôpitaux, des dépôts alimentaires, des pièces stériles, des ordinateurs, des bureaux et bien plus encore.

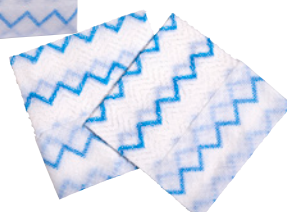

QM-8580	Q-Star Microfiber Roll – White – 13.7x 9.7" / 35 x 25 cm - 110 Sheets per roll / Rouleau microfibre Q-Star - blanc 13.7x 9.7" / 35 x 25 cm - dans 110 feuilles par rouleau	9/Case	\$ 46.53
DIS-8113	Disposable Microfiber wipe-30x30cm/12"x12"-60gsm /	60/bag/ 12bags/ box= 720 ea	\$ 22.07
MC-700BL	MicroScrubber-Microfiber all purpose Scrubber 8X12CM-3PK/Hang-Up-3EA/PK/12PACK/CSE	12/ 3 Pack Master 360 Ea	\$ 18.64

Swipe Wipes Lingettes



M2 Professional vous apporte une suite de produits-solution pour vos besoins opérationnels du service alimentaire.

Nos produits sont conçus comme des solutions de nettoyage dans la zone de préparation / Cuisine, salle à manger, et installations sanitaires.

Les serviettes de service M2 sont un remplacement de linge de haute qualité offrant une performance exceptionnelle dans divers établissements de restauration.

Les serviettes de service alimentaire M2 peuvent être codées par couleur dans une variété de catégories, et sont disponibles dans des boîtes de distribution.



M2 Professional brings you a suite of product solutions for your foodservice operational needs. Our products are designed as a cleaning solutions in the Prep Area/ Kitchen, Front-of-House/ Dinning, and Facility Areas/Restrooms.

M2 foodservice towels are a high quality linen replacement for outstanding performance in a variety of foodservice establishments.

M2 foodservice towels can be Color Coded in a variety of grades, and are available in dispenser boxes.

Benifits / Avantages:

- Linen Replacement / Remplacement de linge
- Colour Coded System / Système à code couleur
- Reusable / Réutilisable
- Hygienic / Hygiénique
- Washable / Lavable
- Rinsible / Facile à rincer
- Absorbent / Absorbant
- Durable
- Cost Savings / Économie de coûts



M2 Code Code M2	Description	Pack Wt LB (S) Poids (lb) (S)	Pack Wt KG Poids (kg)	Cubic Ft Pi3	Pack Contenu	List Price Liste des prix
PREMIUM FOODSERVICE WIPE / ESSUIE-TOUT DE QUALITÉ SUPÉRIEURE DE SERVICE ALIMENTAIRE						
FS-7210-WH	Antimicrobial Foodservice Wipe - 13.25" x 21" / 33.6 x 53.4 cm - White / Lingette antimicrobienne pour service alimentaire - 13.25" x 21" / 33.6 x 53.4 cm - Blanc	4 lbs			150 Per Case	\$ 87.34
FS-8211-WH	Absorbent Foodservice Wipe- 13.25" x 21" / 33.6 x 53.4 cm - White / Lingette absorbantes de service alimentaire - 13.25" x 21" / 33.6 x 53.4 cm - Blanc	4 lbs			150 Per Case	\$ 84.75
FS-8211-BL	Absorbent Foodservice Wipe- 13.25" x 21" / 33.6 x 53.4 cm - Blue / Lingettes absorbantes de service alimentaire - 13.25" x 21" / 33.6 x 53.4 cm - Bleu	4 lbs			150 Per Case	\$ 84.75
FS-8211-RD	Absorbent Foodservice Wipe- 13.25" x 21" / 33.6 x 53.4 cm - Red/Peach / Lingette absorbante de service alimentaire - 13.25" x 21" / 33.6 x 53.4 cm - Rouge/Pêche	4 lbs			150 Per Case	\$ 84.75
FOODSERVICE WIPE / ESSUIE-TOUT DE SERVICE ALIMENTAIRE						
FS-6224-RD	Foodservice Wipe - 13.25" x 20" / 33 x 51 cm - Pink / Lingette de service alimentaire - 13.25" x 20" / 33.6 x 51 cm - Rose	3 lbs			200 Per Case	\$ 65.38
FS-6224-BL	Foodservice Wipe - 13.25" x 20" / 33 x 51 cm - Blue / Lingette de service alimentaire - 13.25" x 20" / 33.6 x 51 cm - Bleu	3 lbs			200 Per Case	\$ 84.75
FS-6224-GR	Foodservice Wipe - 13.25" x 20" / 33 x 51 cm - Green / Lingette de service alimentaire - 13.25" x 20" / 33.6 x 51 cm - Vert	3 lbs			200 Per Case	\$ 84.75
FS-1619-WH	Bar Wipe 16 x 19" / 40cm x 48cm - White / Lingette de comptoir 16 x 19 / 40 cm x 48 cm - blanc				120/12	\$ 2.88

OIL TREATED DUST CLOTH / CHIFFON À POUSSIÈRE TRAITÉ À L'HUILE

M2 Professional Dust Cloths are engineered to deliver quality dust control to help maintain a clean, and healthy work place. M2 Dust Cloths are treated with mineral oil to attract and retain dirt and dust particles without leaving lint or residue. The cloth is a magnet for dust and dirt. It will leave surfaces clean without the use of sprays and their costs associated with the addition of chemicals.

Les chiffons anti-poussières professionnels M2 sont conçus pour offrir un contrôle de la poussière de qualité et maintenir un lieu de travail propre et sain. Les chiffons anti-poussière M2 sont traités avec de l'huile minérale

pour attirer et retenir les particules de saleté et de poussière sans laisser de peluches ou de résidus. Le tissu est un aimant pour la poussière et la saleté. Il va laisser les surfaces propres sans l'utilisation de vaporisateur et leurs coûts associés avec l'ajout de produits chimiques



M2 Code Code M2	Description	Pack Wt LB (S) Poids (lb) (S)	Pack Wt KG Poids (kg)	Cubic Ft Pi3	Pack Contenu	List Price Liste des prix
OIL TREATED DUSTCLOTH / CHIFFON À POUSSIÈRE TRAITÉ À L'HUILE						
FS-9224-YE	Oil Treated Dustcloths - 24" x 24" / 61 x 61 cm - Yellow Chiffon à poussière traité à l'huile - 24" x 24" / 61 x 61 cm - Jaune	Average Wt 15 lbs			50 Bags/ Case 500	\$ 41.85



SPONGES & SCOURING & UTILITY PADS / ÉPONGES ET TAMPONS À RÉCURER

SCOURING PADS / TAMPONS À RÉCURER



FOAM SPONGE WITH SCOURING PADS / ÉPONGE EN MOUSSE AVEC TAMPONS À RÉCURER



CELLULOSE SPONGE & SCOURING PADS / ÉPONGE EN CELLULOSE ET TAMPONS À RÉCURER



DRY CLEAN SMOKE SPONGE ÉPONGE POUR NETTOYAGE À SEC



M2 Code Code M2	Description	Pack Wt LB (S) Poids (lb) (S)	Pack Wt KG Poids (kg)	Cubic Ft Pi3	Pack Contenu	List Price Liste des prix
SP-HSPI	Premium Scouring Pads - Green - 6" x 9" x .3" / 15 x 22 x 7 cm - Case Pack - 10 x 10 / Tampons à récurer de première qualité, vert, 6 po x 9 po x 0,3 po / 15 x 22 x 7 cm, Lot, 10 x 10	4.4	2	1.4	100/10	\$ 1.43
SP-HSPB	Ecoline Scouring Pads - Green - 6" x 9" x .3" / 15 x 22 x 7 cm - Case Pack - 100 / Tampons à récurer Ecoline, vert, 6 po x 9 po x 0,3 po / 15 x 22 x 7 cm, Lot, 100	4.4	2	1.4	100	\$ 1.22
SP-SSS	Foam Sponge with Scouring Pads - 4" x 6" x 1" / 10 x 15 x 2.5 cm - Case Pack - 5 x 10 / Éponge en mousse avec tampons à récurer, 4 po x 6 po x 1 po / 10 x 15 x 2.5 cm, Lot, 5 x 10	6.1	2.8	1.4	50/5	\$ 1.55
SP-E747	Cellulose Sponge with Scouring Pads - 4" x 6" x .875" / 10 x 15 x 2 cm - Case Pack - 1 x 50 - Green / Éponge en cellulose avec tampons à récurer, 4 po x 6 po x 0,875 po / 10 x 15 x 2 cm, Lot, 1 x 50 - vert	6.1	2.8	.8	50/10	\$ 3.29
SP-E749	Cellulose Sponge with Scouring Pads - 4" x 6" x .875" / 10 x 15 x 2 cm - Case Pack - 1 x 50 - White / Éponge en cellulose avec tampons à récurer, 4 po x 6 po x 0,875 po / 10 x 15 x 2 cm, Lot, 1 x 50 - blanc	6.1	2.8	.8	50/10	\$ 2.83
SP-SM115	Dry Cleaning Smoke Sponge 1-1/2" x 3" x 6", Individually Wrapped, 36 Per Case Éponge pour nettoyage à sec 1 1/2" x 3" x 6", enveloppée individuellement, 36 par caisse				36/1	\$ 13.17

ERASER SPONGE ÉPONGE MAGIQUE



CELLULOSE SPONGE ÉPONGE EN CELLULOSE



GROUT / ÉPONGE À COULIS



UTILITY PADS - LIGHT / TAMPONS À RÉCURER POUR TRAVAUX LÉGERS



UTILITY PADS - COURSE / TAMPONS À RÉCURER POUR GROS TRAVAUX



STAINLESS STEEL SCOUR PUFF HOUPPETTE À RÉCURER EN ACIER INOXYDABLE



Refer to Page --- for Doodle Bug Frame / Se référer à la page --- pour les cadres "Doodle Bug"

ERASER SPONGE / ÉPONGE MAGIQUE

SP-ER900	Eraser Sponge - 4.5" x 6" x 2.25 x 1" / 12 x 6 cm 3,5 cm - Case Pack - 12 x 12 = 144 / Éponge magique, 4,5 po x 6 po x 2,25 x 1 po / 12 x 6 cm 3,5 cm, Lot, 12 x 12 = 144	6.1	2.8	1.8	12	\$ 1.50
SP-ER901	Eraser Sponge - 4.5" x 6" x 2.25 x 1" / 12 x 6 cm 3,5 cm - Case Pack - 12 x 12 = 144 / Éponge magique, 4,5 po x 6 po x 2,25 x 1 po / 12 x 6 cm 3,5 cm, Lot, 12 x 12 = 144	6.1	2.8	1.8	12	\$ 1.77
SP-ER902	Eraser Sponge - 4.5" x 6" x 2.25 x 1" / 12 x 6 cm 3,5 cm - Retail Pack - 2 ea Éponge magique, 4,5 po x 6 po x 2,25 x 1 po / 12 x 6 cm 3,5 cm,				2	\$ 3.35
SP-E745	Cellulose Sponge Only - 4" x 6" x 1.75" / 10 x 15 x 4.5 cm - Case Pack - 1 x 50 / Éponge en cellulose seulement, 4 po x 6 po x 1,75 po / 10 x 15 x 4,5 cm, Lot, 1 x 50	6.1	2.8	1.8	50/10	\$ 5.04
SP-E800	Grouting Sponge / Sharp Edge & Round edge - 7" x 5" x 2" / 18 x 13 x 5 cm - Case Pack / Éponge à coulis / rebord en angle et rebord arrondi, 7 po x 5 po x 2 po / 18 x 13 x 5 cm, Lot	6.1	2.8	1.83	12/1	\$ 5.78

UTILITY PADS / TAMPONS À RÉCURER

SP-UT-WH	White Utility Pads - Light - 9.875" x 4.625" x .9" / 25 x 12 x 22 cm Tampons à récurer blancs pour travaux légers, 9,875 po x 4,625 po x 0,9 po / 25 x 12 x 22 cm	1.1	.5	.7	20	\$ 3.91
SP-UT-BK	Black Utility Pad - Course - 9.875" x 4.625" x .9" 25 x 12 x 22 cm Tampons à récurer noirs pour gros travaux, 9,875 po x 4,625 po x 0,9 po 25 x 12 x 22 cm	1.1	.5	.7	20	\$ 3.91
SP-UT-BL	Blue Utility Pads - Light - 9.875" x 4.625" x .9" / 25 x 12 x 22 cm Tampons à récurer bleus pour travaux légers, 9,875 po x 4,625 po x 0,9 po / 25 x 12 x 22 cm	1.1	.5	.7	20	\$ 3.91
SP-UT-BN	Brown Utility Pad - Course - 9.875" x 4.625" x .9" 25 x 12 x 22 cm Tampons à récurer brun pour gros travaux, 9,875 po x 4,625 po x 0,9 po 25 x 12 x 22 cm	1.1	.5	.7	20	\$ 3.91
SP-SS-50	50G Stainless Steel Scour Puff - Sleeves of 12 - Case Pack 144 (12 x 12) / 50G Houppette à récurer en acier inoxydable - paquet de 144 (caisse 12x12)				12	\$ 3.44

WINDOW CLEANING / NETTOYAGE DES VITRES



WINDOW CLEANING / NETTOYAGE DES VITRES

BRASS HANDLE / POIGNÉE EN LAITON



SWIVEL HANDLE / MANCHE PIVOTANT



BRASS CHANNEL WITH RUBBER / LAME DE LAITON AVEC CAOUTCHOUC



For Use With
FH-360-1T Handle
À Utiliser Avec Le
Manche FH-360-1T

M2 Code Code M2	Description	Pack Wt LB (S) Poids (lb) (S)	Pack Wt KG Poids (kg)	Cubic Ft Pi3	Pack Contenu	List Price Liste des prix
WS-BR00	Brass window squeegee handle / Poignée de raclette à vitres en laiton	3.00	1.36	.15	10	\$ 18.11
WS-SW00	Swivel squeegee handle - For Brass Channels / Poignée pivotante à raclette pour lame en laiton				10	\$ 27.93
BRASS CHANNEL WITH RUBBER / LAME DE LAITON AVEC CAOUTCHOUC						
WS-BR12	12" / 30 cm Channel with rubber - Brass / lame de laiton avec caoutchouc, 12 po / 30 cm	12.80	5.81	.0002	10	\$ 13.11
WS-BR14	14" / 35 cm Channel with rubber - Brass / lame de laiton avec caoutchouc, 14 po / 35 cm	14.75	6.69	.0002	10	\$ 14.49
WS-BR18	18" / 45 cm Channel with rubber - Brass / lame de laiton avec caoutchouc, 18 po / 40 cm	18.70	8.48	.0002	10	\$ 17.28
WS-BR22	22" / 55 cm Channel with rubber - Brass / lame de laiton avec caoutchouc, 22 po / 55 cm	19.70	8.48	.0002	10	\$ 24.29

STAINLESS STEEL HANDLE / POIGNÉE EN ACIER INOXYDABLE



STAINLESS STEEL CHANNEL WITH RUBBER / LAME EN ACIER INOXYDABLE AVEC CAOUTCHOUC



WS-SS00	Stainless steel squeegee handle / Poignée de raclette à vitres en acier inoxydable	3.20	1.45	.15	10	\$ 14.10
STAINLESS STEEL CHANNEL WITH RUBBER / LAME EN ACIER INOXYDABLE AVEC CAOUTCHOUC						
WS-SS12	12" / 30 cm Channel with rubber - Stainless Steel / lame en acier inoxydable avec caoutchouc, 12 po / 30 cm	12.80	5.81	.0002	10	\$ 9.00
WS-SS14	14" / 35 cm Channel with rubber - Stainless Steel / lame en acier inoxydable avec caoutchouc, 14 po / 35 cm	14.75	6.69	.0002	10	\$ 9.83
WS-SS18	18" / 40 cm Channel with rubber - Stainless Steel / lame en acier inoxydable avec caoutchouc, 18 po / 40 cm	18.70	8.48	.0002	10	\$ 11.37
WS-SS22	22" / 55 cm Channel with rubber - Stainless Steel / lame en acier inoxydable avec caoutchouc, 22 po / 55 cm	19.70	8.48	.0002	10	\$ 15.02

RUBBER REFILLS & BRASS CLIP / CAOUTCHOUC DE RECHANGE ET ATTACHE EN LAITON

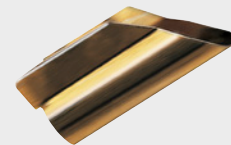

WS-RU12	12" / 30 cm Replacement rubber / Caoutchouc de rechange, 12 po / 30 cm	.50	.23	.12	10	\$ 3.15
WS-RU14	14" / 35 cm Replacement rubber / Caoutchouc de rechange, 14 po / 35 cm	.55	.25	.14	10	\$ 3.48
WS-RU18	18" / 40 cm Replacement rubber / Caoutchouc de rechange, 18 po / 40 cm	.70	.32	.18	10	\$ 4.38
WS-RU22	22" / 55 cm Replacement rubber / Caoutchouc de rechange, 22 po / 55 cm				10	\$ 6.21
WS-RU42	42" / 106 cm Replacement rubber / Caoutchouc de rechange, 42 po / 106 cm				10	\$ 17.08
WS-BR01	Clip for brass window squeegee // Attache en laiton pour raclette à vitres	.1	.05	.01	10	\$.91

PLASTIC SQUEEGEE COMPLETE / RACLETTE EN PLASTIQUE COMPLÈTE



WS-PL12	12" / 30 cm Plastic window squeegee complete / 12" / 30 cm Raclette à vitres en plastique complète	2.2	1.0		10	\$ 15.09
WS-PL18	18" / 45 cm Plastic window squeegee complete / 18" / 45 cm Raclette à vitres en plastique complète	2.8	1.3		10	\$ 18.32

T-BAR HANDLE / SUPPORT EN T



For Use With
FH-360-TT Handle
À Utiliser Avec Le
Manche FH-360-TT



T-BAR HANDLE / SUPPORT EN T							
WS-TB10	10"/25 cm	T-Bar Handle / Support en T, 10 po/25 cm	3.0	1.36	.49	10	\$ 9.18
WS-TB14	14"/35 cm	T-Bar Handle / Support en T, 14 po/35 cm	3.6	1.63	.66	10	\$ 10.55
WS-TB18	18"/45 cm	T-Bar Handle / Support en T, 18 po/45 cm	4.35	1.97	.84	10	\$ 11.74
T-BAR SWIVEL HANDLE / MANCHE RACLETTE VITRES PIVOTANT							
WS-TBS10	10"/25 cm	T-Bar Swivel Handle / Manche Raclette Vitres pivotant, 10 po/25 cm				10	\$ 20.32
WS-TBS14	14"/35 cm	T-Bar Swivel Handle / Manche Raclette Vitres pivotant,, 14 po/35 cm				10	\$ 23.18
WS-TBS18	18"/45 cm	T-Bar Swivel Handle / Manche Raclette Vitres pivotant,, 18 po/45 cm				10	\$ 25.68
WS-TBS22	22"/55 cm	ALUMINUM T-Bar Swivel Handle / Manche Raclette Vitres pivotant - ALUMINUM, 22 po/55 cm				10	\$ 33.56
WS-AC007		Click & Scrub Pad, Clicks on to T-Bar 10 Pcs/Bag - 10 Bags/Box / Tampon "Click & Scrub" s'attache au support en T 10 pcs/sac - 10 sacs/bte				10	\$ 3.05

MICROFIBER WASHING SLEEVE / RECHANGES POUR LAVETTES À VITRES MICROFIBRE



ECONOMY WASHING SLEEVE / RECHANGE POUR LAVETTE ÉCONOMIQUE							
WS-WS10	10"/25 cm	Washing sleeve refill / Rechange pour lavette à vitres, 10 po/25 cm	1.05	.48	.20	10	\$ 11.59
WS-WS14	14"/35 cm	Washing sleeve refill / Rechange pour lavette à vitres, 14 po/35 cm	1.40	.64	.29	10	\$ 13.83
WS-WS18	18"/45 cm	Washing sleeve refill / Rechange pour lavette à vitres, 18 po/45 cm	1.70	.77	.37	10	\$ 16.08
WS-WS22	22"/55 cm	Washing sleeve refill / Rechange pour lavette à vitres, 22 po/55 cm				10	\$ 33.78
WASHING SLEEVE REFILL WITH ABRASIVE STRIP / RECHANGE POUR LAVETTE AVEC BANDE ABRASIVE							
WS-WSAB14	14"/35 cm	Washing sleeve refill with abrasive strip / Rechange pour lavette avec bande abrasive, 14 po/35 cm				10	\$ 23.45
WS-WSAB18	18"/45 cm	Washing sleeve refill with abrasive strip / Rechange pour lavette avec bande abrasive,, 18 po/45 cm				10	\$ 26.74
MICROFIBER WASHING SLEEVE - GREY / RECHANGE DE LAVETTE MICROFIBRE - GRIS							
WS-WSEM10	10"/25 cm	Microfiber washing sleeve refill - Grey / Rechange pour lavette à vitres, 14 po/35 cm - gris	1.40	.64	.29	10	\$ 20.89
WS-WSEM14	14"/35 cm	Microfiber washing sleeve refill - Grey / Rechange pour lavette à vitres, 14 po/35 cm - gris	1.40	.64	.29	10	\$ 24.24
WS-WSEM18	18"/45 cm	Microfiber washing sleeve refill - Grey/ Rechange pour lavette à vitres, 18 po/45 cm - gris	1.70	.77	.37	10	\$ 29.08
MICROFIBER WASHING SLEEVE - BLUE / RECHANGE DE LAVETTE MICROFIBRE - BLEU							
WS-WSEM10P	10"/25 cm	Microfiber washing sleeve refill - Blue / Rechange pour lavette à vitres, 14 po/35 cm - bleu	1.40	.64	.29	10	\$ 15.72
WS-WSEM14P	14"/35 cm	Microfiber washing sleeve refill - Blue / Rechange pour lavette à vitres, 14 po/35 cm - bleu	1.40	.64	.29	10	\$ 18.24
WS-WSEM18P	18"/45 cm	Microfiber washing sleeve refill - Blue/ Rechange pour lavette à vitres, 18 po/45 cm - bleu	1.70	.77	.37	10	\$ 21.89



WINDOW SQUEEGEE



M2 Code Code M2	Description	Pack Wt LB (S) Poids (lb) (S)	Pack Wt KG Poids (kg)	Cubic Ft Pi3	Pack Contenu	List Price Liste des prix
FS-MP10-WH	10" Moss Counter Squeegee with Natural Rubber - White, Blue, Red, Yellow Green				10/1	\$ 48.84

WINDOW BUCKET /SEAU À VITRES



- High impact buckets with waxing sieve
- Strong durable handle for easy carrying
- Wheels for easy maneuverability
- Seau très résistant avec tamis pour appliquer la cire
- Transport facile grâce à l'anse robuste et durable
- Roulettes pour une grande maniabilité

M2 Code Code M2	Description	Pack Wt LB (S) Poids (lb) (S)	Pack Wt KG Poids (kg)	Cubic Ft Pi3	Pack Contenu	List Price Liste des prix
PA-W1120	Window Bucket with Caddy and Wheels – Yellow / Seau à vitres, jaune	26.5	12	3.7	5/1	\$ 45.37



M2 Code Code M2	Description	Pack Wt LB (S) Poids (lb) (S)	Pack Wt KG Poids (kg)	Cubic Ft Pi3	Pack Contenu	List Price Liste des prix
EFM-PS-10100-BL	Window Bucket - Blue / Seau à vitres - bleu				10/1	\$ 53.80
EFM-PS-10101-BL	Window Bucket Lid - Blue / Couverture pour seau à vitres - bleu				1	\$ 28.74
EFM-PS-10102-RD	Window Bucket - Red / Seau à vitres - rouge				10/1	\$ 47.92
EFM-PS-10103-RD	Window Bucket Lid- Red / Couverture pour seau à vitres - rouge				1	\$ 28.74
EFM-PS-10104	Presoak Bucket Wheels Only (Set of 4) / Roues pour seau de pré-trempage seulement (pq de 4)				1	\$ 32.06

ACCESSORIES

TOOL HOLDER / PORTE-OUTILS

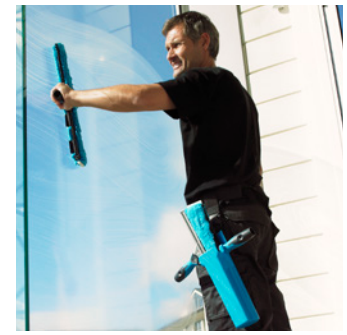

M2 Code Code M2	Description	Pack Wt LB (S) Poids (lb) (S)	Pack Wt KG Poids (kg)	Cubic Ft Pi3	Pack Contenu	List Price Liste des prix
WS-AC003	Tool Holder / Porte-outils	4.6	2.0		5/1	\$ 46.68
WS-AC004	Tool Holder Belt / Ceinture de porte-outils	2.2	1.0		5/1	\$ 36.06

CAR SQUEEGEE / RACLETTE D'AUTOMOBILE

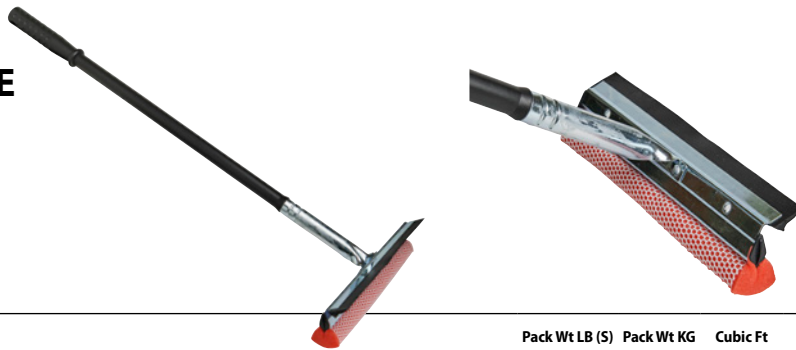

M2 Code Code M2	Description	Pack Wt LB (S) Poids (lb) (S)	Pack Wt KG Poids (kg)	Cubic Ft Pi3	Pack Contenu	List Price Liste des prix
WS-CS1021-P	10" Car squeegee with 24" Heavy Duty Plastid Handle /				12	\$ 9.75

CLEANO STATE OF ART IN INDOOR WINDOW CLEANING AND OTHER WASHABLE SURFACES / LE SUMMON DANS LE NETTOYAGE DES VITRES INTÉRIEURES ET AUTRES SURFACES LAVABLES



BALL VALVE

The use of a ball valve provides added benefits for the user:

- The refill can be applied at any angle.

RÉSERVOIR OVAL

L'utilisation d'un réservoir oval ajoute des bénéfices pour l'utilisateur:

- Le remplissage peut se faire dans n'importe quel angle



NO-TWIST MECHANISM

- The mechanical pump is operated by hand.

MÉCANISME ANTI-TORSION

- La pompe mécanique est actionnée à la main.



MICRO-SPRAY

Optimal distribution of the right amount of pure water on the surface

MICRO-PULVÉRISATION

Une répartition optimale de la bonne quantité d'eau pure sur la surface

**CLEANS GLASS FAST...
IN ONE PASS!
NETTOIE LES VITRES
RAPIDEMENT EN
UN PASSAGE SEULEMENT**

**CAN ALSO BE
USED DRY!
PEUT AUSSI ÊTRE
UTILISÉ À SEC**

CLEANOPAD

- Launderable pads
- Microfibre pad for window cleaning.
- Seamless microfibre, no streaks, no smudges.
- Slides smoothly, degreases, absorbs.
- Cleans without detergent.

TAMPON CLEANO

- Tampons lavable
- Tampon en microfibre pour le nettoyage des fenêtres
- Microfibre sans couture, sans stries, sans bavures
- Glisse en douceur, dégraisse, absorbe
- Nettoie sans détergent

WS-CL-15060	Cleano Telescopic combo tool-3 microfibre pads included for indoor window cleaning / Outil télescopique pour le nettoyage des vitres JR intérieures avec 3 mouilleurs en microfibre				1	\$656.02
WS-CL-15061	Cleano Microfibre Glass Mop Pad - Blue Only window cleaning Mouilleur microfibre nettoyage de vitres				5	\$ 22.61



EXTENSION HANDLES / MANCHES EXTENSIBLES

EXTENSION HANDLES – 2 PIECE /
MANCHES EXTENSIBLES EN 2 PARTIES

TELESCOPIC POLE HOLDER BASE /
SUPPORT DE PERCHE TÉLESCOPIQUE

TELESCOPIC POLE THREAD ADAPTER /
ADAPTATEUR FILETÉ DE PERCHE TÉLESCOPIQUE



M2 Code Code M2	Description	Pack Wt LB (S) Poids (lb) (S)	Pack Wt KG Poids (kg)	Cubic Ft Pi3	Pack Contenu	List Price Liste des prix
2 PIECE EXTENSION HANDLE / MANCHES EXTENSIBLES EN 2 PARTIES						
WS-TP08-2	8' Telescopic pole in 2 pieces – 8 ft/2.4m / Perche télescopique en 2 parties, 8 pi / 2,4m	9.5	4.3	1.1	5/1	\$ 52.38
WS-TP12-2	12' Telescopic pole in 2 pieces – 12 ft/3.6m / Perche télescopique en 2 parties, 12 pi / 3,6m	15.4	6.9	1.6	5/1	\$ 58.48
3 PIECE EXTENSION HANDLE / MANCHES EXTENSIBLES EN 3 PARTIES						
WS-TP09-3	9' Telescopic pole in 3 pieces – 9.8 ft/3m / Perche télescopique en 3 parties, 9,8 pi / 3m	10	4.5	.63	5/1	\$ 73.48
WS-TP16-3	16' Telescopic pole in 3 pieces – 16.4 ft/5m / Perche télescopique en 3 parties, 16,4 pi / 5m				5/1	\$ 124.01
4 PIECE EXTENSION HANDLE / MANCHES EXTENSIBLES EN 4 PARTIES						
WS-TP16-4-M	16' Telescopic pole in 4 pieces – 16.4 ft/5m / Perche télescopique en 4 parties, 16,4 pi / 5m	15.8	7.1	.90	5/1	\$ 119.24
WS-TP20-4-M	20' Telescopic pole in 4 pieces – 20 ft / 6m / Perche télescopique en 4 parties, 20 pi / 6m				5/1	\$ 179.62
WS-TP20-3	20' Telescopic pole in 3 pieces – 20 ft / 6m / Perche télescopique en 4 parties, 20 pi / 6m				5/1	\$ 179.62
WS-TP30-3	30' Telescopic pole in 3 pieces – 30ft x 9 m / 30' Perche télescopique en 3 pièces - 30'/9m				5/1	\$ 283.09
TELESCOPIC POLE ADAPTER						
WS-TP100-P	Threaded cone adapter / Adaptateur conique fileté	.7	.35	.10	10/1	\$ 7.49
WS-TP100-M	Threaded cone adapter / Adaptateur conique fileté	.7	.35	.10	10/1	\$ 7.49
WS-TP102	Cone and Clamp for 2 Piece Telescopic Pole – 1 Small Set / Nécessaire cône de sécurité et pince de fixation pour perche télescopique en 2 parties, 1 petit ensemble	.7	.35	.10	5/1	\$ 11.64
WS-TP103	Cone and Clamp for 3 Piece Telescopic Pole – 1 Medium Set / Nécessaire cône de sécurité et pince de fixation pour perche télescopique en 3 parties, 1 moyen ensemble	.7	.35	.10	5/1	\$ 12.53
WS-TP104	Cone and Clamp for 3 Piece Telescopic Pole – 1 Large Set / Nécessaire cône de sécurité et pince de fixation pour perche télescopique en 3 parties, 1 grande ensemble	.7	.35	.10	5/1	\$ 13.35

FLEX SAFETY WINDOW SCRAPER / GRATTOIR À VITRES DE SÉCURITÉ FLEX



WS-SC205

WS-SC2-2



WS-SC1	1 1/2" / 3.8 cm Flex Safety Scraper / Grattoir de sécurité Flex, 1 1/2 po / 3.8 cm	2.8	1.3		20/1	\$ 8.23
WS-SC205	1 1/2" Economy Safety Scraper /					\$ 7.31
WS-SC2	10cm Scraper with 10 Blades in Plastic Case / Grattoir 10 cm avec 10 lames dans un coffret en plastique	1	.4		10/1	\$ 13.28
WS-SC2-1	10cm Scraper Holder Only	1	.4		10/1	\$ 10.33
WS-SC2-2	10cm Scraper Blades Only - 10 Blade/Pack	1	.4		10/1	\$ 13.60
WS-SCR003	Flex Scraper Blades – 1 1/2" – Refill Blades (100 Blades) / Lames de rechange (100) pour grattoir Flex, 1 1/2 po	1	.4		100	\$.54

WINDOW & FLOOR SCRAPERS / FENÊTRE ET ÉTAGE RACLEUR

4" FLEX SCRAPER & COMFORT GRIP

GRATTOIR FLEX DE 4 PO DE LARGEUR AVEC POIGNÉE ERGONOMIQUE



WS-SC4



WS-SCR001



WS-SCR002

M2 Code Code M2	Description	Pack Wt LB (S) Poids (lb) (S)	Pack Wt KG Poids (kg)	Cubic Ft Pi3	Pack Contenu	List Price Liste des prix
WS-SC4	4" / 10 cm Wide Flex Scraper with Comfort Grip / Grattoir Flex de 4 po/ 10 cm de largeur avec poignée ergonomique	5	2.2	.33	10	\$ 24.20
WS-SCR001	4" / 10 cm Flex Razor Blades – 4" x .2 mm – (25 Blades/Dispenser) / Lames de rasoir Flex de 4 po de largeur, 4 po x 0,2mm (étui de 25 lames)	2.5	1.1	.74	25	\$ 1.07
WS-SCR002	4" / 10 cm Flex Scraper Blades – 4" x .4 mm – (25 Blades) / Lames de grattoir Flex de 4 po de largeur, 4 po x 0,4mm (25 Lames)	2.5	1.1	.68	25	\$ 1.25

8" Plastic handle scraper with reversible 4" sharp double edge is ideal for removing chewing gum, tape and paint

Le grattoir à poignée en plastique (8 po) avec une lame à double tranchant réversible (4 po) est idéal pour enlever de la gomme à mâcher, du ruban adhésif et de la peinture.



WS-SR01510



WS-SR01640



WS-SC48

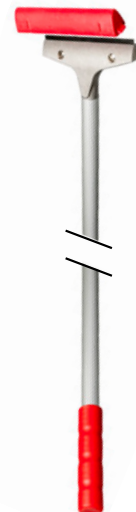

WS-SCR56



WS-SCR1641



WS-SR01540

* FH-W360-1T Handle Sold Separately. Refer to Page ---- / * FH-W360-1T Le manche est vendu séparément. Référez-vous à la page ----

M2 Code Code M2	Description	Pack Wt LB (S) Poids (lb) (S)	Pack Wt KG Poids (kg)	Cubic Ft Pi3	Pack Contenu	List Price Liste des prix
WS-SR01510	8 1/2"/24 cm Small Plastic Handle Scraper with Cover / Petit grattoir à poignée en plastique 8 1/2 po/24 cm, avec protège-lame	49	22	1.4	10	\$ 22.33
WS-SR01530	11 1/2"/30 cm Large Scraper / Grand grattoir, 11 1/2 po/30 cm	36	16.5	1.4	10	\$ 14.74
WS-SR01540	4" Scraper Refill Blades - Singles / Lames de rechange				10	\$ 0.96
WS-SCR1640	10"/24 cm Aluminum Scraper with Handle / 10"/24cm Grattoir en aluminium avec manche				10	\$ 31.24
WS-SCR1641	4" Scraper Refill Blades – Dispenser Pack (10 Blades) / Lames de rechange (10) pour grattoir Flex, 4 po				10	\$ 18.16
WS-SC48	4"/ 10 cm Wide Flex Scraper with 48"/121 cm Handle / Grattoir Flex de 4 po/ 10 cm de largeur, manche de 48 po/121 cm	10.35	4.6	1.5	5	\$ 40.58
WS-SCR56	Maxi Scrap floor scraper (Aluminum Handle L-150 cm Blade L-17cm x W-3,5cm /60" x 6.6" x 1.37") - Maxi scrap grattoir pour sols manche aluminium-150 cm Recharge lame L-17cm x W-3,5 cm /60 x 6.6" x 1.37 po				10/1	\$ 99.79
WS-SCR56R	Maxi scrap floor scraper Refill Blades - L-17 cm x W-3.5 cm / 6.6" x 1.37" - Maxi scrap Recharge lame L-17cm x W-3.5 cm/ 6.6 x 1.37 po				10/1	\$ 9.67



MICROPAD VELCRO SYSTEM / SYSTÈME TAMPON "MICROPAD" VELCRO

The MicroPads are the next generation in microfibre cleaning. Made with Ultrafine microfibers, a better removal of dirt and bacteria is achieved versus the traditional method. Can be used wet dry or damp cleaning The colour code fringe helps reduce cross contamination. Velcro backing provides durability and attaches more securely to the frame.

Les "MicroPad" sont la prochaine génération en nettoyage microfibre. Fait de microfibres ultra-fine, ils assurent une meilleure élimination de la saleté et des bactéries, versus la vieille méthode traditionnelle. Peut être utiliser mouillé, sec ou humide. La frange de couleur codée aide à réduire la contamination croisée. La doublure de velcro dure plus longtemps et s'attache plus facilement au châssis.



18" / 45 cm



M2 Code Code M2	Description	Pack Wt LB (5) Poids (lb) (5)	Pack Wt KG Poids (kg)	Cubic Ft Pi3	Pack Contenu	List Price Liste des prix
MFP-4010-BL	MicroFiber Pads -10" / 25cm - Blue / Tampons M-Fibre 10" / 25 cm - bleu				12	\$ 9.96
MFP-4018-BL	MicroFiber Pads -18" / 45cm Blue / Tampons M-Fibre 18" / 45cm - bleu				12	\$ 11.57
MFP-4018-RD	MicroFiber Pads -18" / 45 cm - Red / Tampons M-Fibre 18" / 45 cm - rouge				12	\$ 11.57
MFP-4018-YE	MicroFiber Pads -18" / 45 cm - Yellow / Tampons M-Fibre 18" / 45 cm - jaune				12	\$ 11.57
MFP-4018-GN	MicroFiber Pads -18" / 45 cm - Green / Tampons M-Fibre 18" / 45 cm - vert				12	\$ 11.57
MFP-4024-BL	MicroFiber Pads -24" / 60cm Blue / Tampons M-Fibre 24" / 60cm - bleu				12	\$ 17.12
MFP-4036-BL	MicroFiber Pads -36" / 90cm Blue / Tampons M-Fibre 36" / 90cm - bleu				12	\$ 29.53

MICRO STRIP VELCRO PADS / TAMPONS VELCRO

Especially on hard floors like marble, travertine, granite, porcelain. Cleaning and disinfection takes place after the mop is soaked with water and mixed with diluted detergent.

Perfect on dry stains. The micro abrasive strip removes stubborn dirt and grease without scratching the surface

Utilisé surtout sur les sols durs comme le marbre, le travertin, le granit ou la porcelaine. Le nettoyage et la désinfection ont lieu après que la vadrouille ait été préalablement imprégnée d'eau et mélangée avec un détergent dilué. Parfait sur les taches sèches. La bande micro abrasive enlève la saleté et la graisse tenace sans rayer la surface.



Micro-Fibre DryPad/w Fringe will remove more dirt and bacteria than old traditional methods.

With the added looped fringe the Micro-dry pad picks up and holds even more dust and larger debris

Le tampon sec en microfibres avec frange éliminera plus de saleté et de bactéries que les anciennes méthodes traditionnelles. Avec la frange bouclée ajoutée, le tampon micro-sec ramasse et retient encore plus de poussière et de plus gros débris.

The MicroStrip replacement pad is ideal for both wet and dry cleaning / La recharge de tampon "Microstrip" est idéale aussi bien pour le nettoyage humide ou sec.

VELCRO MICROSTRIP PAD / TAMPON MICROSTRIP VELCRO						
EFM-FMV64510	Velcro Flat Mop MicroStrip MicroFibrer Pad 10" / 25 cm white/w stripe / Tampon Velcro en microfibre pour vadrouille plate "MicroStrip" 10" / 25 cm blanc/ rayures				12/1	\$ 17.22
EFM-FMV64516	Velcro Flat Mop MicroStrip MicroFibrer Pad 16" / 40 cm white/w stripe / Tampon Velcro en microfibre pour vadrouille plate "MicroStrip" 16" / 40 cm blanc/ rayures	6.3	3		12/1	\$ 18.32
EFM-FMV64518	Velcro Flat Mop MicroStrip MicroFiber Pad 18" / 45 cm white/w stripe / Tampon Velcro en microfibre pour vadrouille plate "MicroStrip" 18" / 45 cm blanc/ rayures	7.2	3.3		12/1	\$ 19.21
EFM-FMV64524	Velcro Flat Mop MicroStrip MicroFiber Pad 24" / 60 cm white/w stripe / Tampon Velcro en microfibre pour vadrouille plate "MicroStrip" 24" / 60 cm blanc/ rayures	9.4	4.3		12/1	\$ 21.82
EFM-FMV64540	Velcro Flat Mop MicroStrip MicroFiber Pad 40" / 100 cm white/w stripe / Tampon Velcro en microfibre pour vadrouille plate "MicroStrip" 40" / 100cm blanc/ rayures	15.1	6.9		12/1	\$ 55.96
VELCRO MICROFIBER DRYPAD WITH FRINGE / VELCRO MICROFIBER DRYPAD AVEC FRANGES						
MFP-5518	18" / 45 cm Micro-Fibre DryPad with Fringe - Green / DryPad microfibre de 18 po / 45 cm avec franges - vert				12/6	\$ 27.26
MFP-5524	24" / 60 cm Micro-Fibre DryPad with Fringe - Green / DryPad microfibre de 24" / 60 cm avec franges - ver				12/6	\$ 32.34
MFP-5536	36" / 91 cm Micro-Fibre DryPad with Fringe - Green / DryPad microfibre de 36" / 91 cm avec franges - ver				12/6	\$ 50.20

MICRO STRIP VELCRO PADS / TAMPONS VELCRO

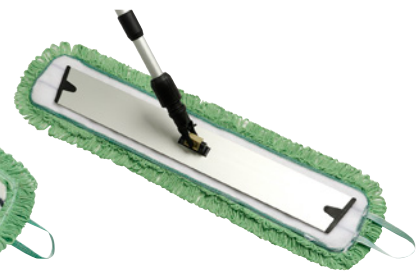
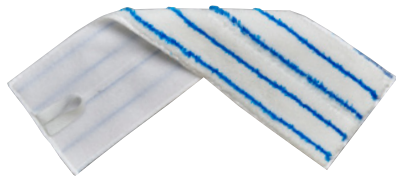

M2 Code Code M2	Description	Pack Wt LB (S) Poids (lb) (S)	Pack Wt KG Poids (kg)	Cubic Ft Pi3	Pack Contenu	List Price Liste des prix
MICROLIGHT VELCRO FLAT MOP MICROFIBER PAD						
EFM-FM64410	10"/25 cm MicroLight Velcro Flat Mop MicroFiber Pad - White with Blue Soft Scrub Strip /				12/1	\$ 16.31
EFM-FM64416	16"/40 cm MicroLight Velcro Flat Mop MicroFiber Pad 10"/25 cm White with Blue Soft Scrub Strip /				12/1	\$ 17.40
EFM-FM64418	18"/45 cm MicroLight Velcro Flat Mop MicroFiber Pad 10"/25 cm White with Blue Soft Scrub Strip /				12/1	\$ 18.25
EFM-FM64424	24"/60 cm MicroLight Velcro Flat Mop MicroFiber Pad 10"/25 cm White with Blue Soft Scrub Strip /				12/1	\$ 20.73
EFM-FM64436	36"/92 cm MicroLight Velcro Flat Mop MicroFiber Pad 10"/25 cm White with Blue Soft Scrub Strip /				12/1	\$ 53.16
MICROSTRIP VELCRO MICROFIBER PAD WITH FRINGE						
EFM-FMV64710	10"/25 cm MicroStrip Velcro MicroFiber Pad with Fringe Flat Mop				12	\$ 17.78
EFM-FMV64716	16"/40 cm MicroStrip Velcro MicroFiber Pad with Fringe Flat Mop				12	\$ 18.86
EFM-FMV64718	18"/45 cm MicroStrip Velcro MicroFiber Pad with Fringe Flat Mop				12	\$ 19.79
EFM-FMV64724	24"/60 cm MicroStrip Velcro MicroFiber Pad with Fringe Flat Mop				12	\$ 22.48
EFM-FMV64736	36"/92 cm MicroStrip Velcro MicroFiber Pad with Fringe Flat Mop				12	\$ 57.64

VELCRO ECONOMICAL FLAT MOPPING SYSTEMS / SYSTÈME DE TAMPONS VELCRO PLATS ÉCONOMIQUESZ

M-TECH FLAT MICROFIBRE MOP PAD / TAMPON DE VADROUILLE PLATE EN MICROFIBRE M-TECH

WET / HUMIDE



DRY / SEC



WET-DRY / HUMIDE-SEC



M2 Code Code M2	Description	Pack Wt LB (S) Poids (lb) (S)	Pack Wt KG Poids (kg)	Cubic Ft Pi3	Pack Contenu	List Price Liste des prix
M-TECH DRY VELCRO MOPPAD / TAMPON VELCRO DE VADROUILLE SÈCHE " "						
MFP-V5210-GY	M-Tech Velcro Flat Microfiber Mop Pad - 10"/25 cm - Dry - Grey / "M-Tech" Tampon de vadrouille plate en microfibre avec velcro - 10"/25 cm - sec - gris				12/1	\$ 20.11
MFP-V5216-GY	M-Tech Velcro Flat Microfiber Mop Pad - 16"/40 cm - Dry - Grey / "M-Tech" Tampon de vadrouille plate en microfibre avec velcro - 16"/40 cm - sec - gris				12/1	\$ 21.49
MFP-V5218-GY	M-Tech Velcro Flat Microfiber Mop Pad - 18"/45 cm - Dry - Grey / "M-Tech" Tampon de vadrouille plate en microfibre avec velcro - 18"/45 cm - sec - gris				12/1	\$ 22.82
MFP-V5224-GY	M-Tech Velcro Flat Microfiber Mop Pad - 24"/60 cm - Dry - Grey / "M-Tech" Tampon de vadrouille plate en microfibre avec velcro 24"/60 cm - sec - gris				12/1	\$ 28.85
MFP-V5236-GY	M-Tech Velcro Flat Microfiber Mop Pad - 36"/92 cm - Dry - Grey / "M-Tech" Tampon de vadrouille plate en microfibre avec velcro 36"/92 cm - sec - gris				12/1	\$ 44.57
M-TECH PET WET/DRY VELCRO MOPPAD / TAMPON VELCRO DE VADROUILLE HUMIDE-SÈCHE "M-TECH PET"						
MFP-V4310	PET Velcro Flat Microfiber Mop Pad 10"/25 cm - Green/White - Wet-Dry / PET Tampon microfibre de vadrouille plate avec velcro 10"/25 cm - Vert/Blanc - Humide/Sec				12/1	\$ 20.11
MFP-V4316	PET Velcro Flat Microfiber Mop Pad 16"/40 cm - Green/White - Wet-Dry / PET Tampon microfibre de vadrouille plate avec velcro 16"/40 cm - Vert/Blanc - Humide/Sec				12/1	\$ 21.49
MFP-V4318	PET Velcro Flat Microfiber Mop Pad 18"/45 cm - Green/White - Wet-Dry / PET Tampon microfibre de vadrouille plate avec velcro 18"/45 cm - Vert/Blanc - Humide/Sec				12/1	\$ 22.82
MFP-V4324	PET Velcro Flat Microfiber Mop Pad 24"/60 cm - Green/White - Wet-Dry / PET Tampon microfibre de vadrouille plate avec velcro 24"/60 cm - Vert/Blanc - Humide/Sec				12/1	\$ 28.85
MFP-V4336	PET Velcro Flat Microfiber Mop Pad 36"/90 cm - Green/White - Wet-Dry / PET Tampon microfibre de vadrouille plate avec velcro 36"/90 cm - Vert/Blanc - Humide/Sec				12/1	\$ 44.57



M-TECH FLAT MICROFIBRE MOP PAD / TAMPON DE VADROUILLE PLATE EN MICROFIBRE M-TECH



M2 Code Code M2	Description	Pack Wt LB (S) Poids (lb) (S)	Pack Wt KG Poids (kg)	Cubic Ft Pi3	Pack Contenu	List Price Liste des prix
M-TECH WET VELCRO FLAT MOP - GREEN / M-TECH VADROUILLE PLATE HUMIDE - VERTE						
MFP-V4210-GN	M-Tech Velcro Flat Microfiber Mop Pad - 10"/ 25 cm - Dry - Green / "M-Tech" Tampon de vadrouille plate en microfibre avec velcro - 10"/25 cm - sec - vert				12/1	\$ 20.11
MFP-V4216-GN	M-Tech Velcro Flat Microfiber Mop Pad - 16"/ 40 cm - Dry - Green/ "M-Tech" Tampon de vadrouille plate en microfibre avec velcro - 16"/40 cm - sec - vert				12/1	\$ 21.49
MFP-V4218-GN	M-Tech Velcro Flat Microfiber Mop Pad - 18"/ 45 cm - Dry - Green / "M-Tech" Tampon de vadrouille plate en microfibre avec velcro - 18"/45 cm - sec - vert				12/1	\$ 22.82
MFP-V4224-GN	M-Tech Velcro Flat Microfiber Mop Pad - 24"/ 60 cm - Dry - Green / "M-Tech" Tampon de vadrouille plate en microfibre avec velcro 24"/60 cm - sec - vert				12/1	\$ 28.85
MFP-V4236-GN	M-Tech Velcro Flat Microfiber Mop Pad - 36"/ 92 cm - Dry - Green/ "M-Tech" Tampon de vadrouille plate en microfibre avec velcro 36"/92 cm - sec - vert				12/1	\$ 44.57
M-TECH WET VELCRO FLAT MOP - BLUE / M-TECH VADROUILLE PLATE HUMIDE - BLEU						
MFP-V4210-BL	M-Tech Velcro Flat Microfiber Mop Pad - 10"/ 25 cm - Wet- Blue / "M-Tech" Tampon de vadrouille plate en microfibre avec velcro - 10"/25 cm - humide - bleu				12/1	\$ 20.11
MFP-V4216-BL	M-Tech Velcro Flat Microfiber Mop Pad - 16"/ 40 cm - Wet- Blue/ "M-Tech" Tampon de vadrouille plate en microfibre avec velcro - 16"/40 cm - humide - bleu				12/1	\$ 21.49
MFP-V4218-BL	M-Tech Velcro Flat Microfiber Mop Pad - 18"/ 45 cm - Wet- Blue / "M-Tech" Tampon de vadrouille plate en microfibre avec velcro - 18"/45 cm - humide - bleu				12/1	\$ 22.82
MFP-V4224-BL	M-Tech Velcro Flat Microfiber Mop Pad - 24"/ 60 cm - Wet- Blue / "M-Tech" Tampon de vadrouille plate en microfibre avec velcro 24"/60 cm - humide - bleu				12/1	\$ 28.85
MFP-V4236-BL	M-Tech Velcro Flat Microfiber Mop Pad - 36"/ 92 cm - Wet- Blue / "M-Tech" Tampon de vadrouille plate en microfibre avec velcro 36"/92 cm - humide - bleu				12/1	\$ 44.57
M-TECH WET VELCRO FLAT MOP - RED / M-TECH VADROUILLE PLATE HUMIDE - ROUGE /						
MFP-V4210-RD	M-Tech Velcro Flat Microfiber Mop Pad - 10"/ 25 cm - Dry - Red / "M-Tech" Tampon de vadrouille plate en microfibre avec velcro - 10"/25 cm - sec - rouge				12/1	\$ 20.11
MFP-V4216-RD	M-Tech Velcro Flat Microfiber Mop Pad - 16"/ 40 cm - Dry - Red / "M-Tech" Tampon de vadrouille plate en microfibre avec velcro - 16"/40 cm - sec - rouge				12/1	\$ 21.49
MFP-V4218-RD	M-Tech Velcro Flat Microfiber Mop Pad - 18"/ 45 cm - Dry -Red / "M-Tech" Tampon de vadrouille plate en microfibre avec velcro - 18"/45 cm - sec - rouge				12/1	\$ 22.82
MFP-V4224-RD	M-Tech Velcro Flat Microfiber Mop Pad - 24"/ 60 cm - Dry - Red / "M-Tech" Tampon de vadrouille plate en microfibre avec velcro 24"/60 cm - sec - rouge				12/1	\$ 28.85
MFP-V4236-RD	M-Tech Velcro Flat Microfiber Mop Pad - 36"/ 92 cm - Dry -Red / "M-Tech" Tampon de vadrouille plate en microfibre avec velcro 36"/92 cm - sec - rouge				12/1	\$ 44.57
M-TECH DRY VELCRO FLAT MOP - YELLOW / M-TECH VADROUILLE PLATE HUMIDE - JAUNE						
MFP-V4210-YE	M-Tech Velcro Flat Microfiber Mop Pad - 10"/ 25 cm - Dry - Yellow / "M-Tech" Tampon de vadrouille plate en microfibre avec velcro - 10"/25 cm - sec -jaune				12/1	\$ 20.11
MFP-V4216-YE	M-Tech Velcro Flat Microfiber Mop Pad - 16"/ 40 cm - Dry - Yellow / "M-Tech" Tampon de vadrouille plate en microfibre avec velcro - 16"/40 cm - sec -jaune				12/1	\$ 21.49
MFP-V4218-YE	M-Tech Velcro Flat Microfiber Mop Pad - 18"/ 45 cm - Dry - Yellow / "M-Tech" Tampon de vadrouille plate en microfibre avec velcro - 18"/45 cm - sec -jaune				12/1	\$ 22.82
MFP-V4224-YE	M-Tech Velcro Flat Microfiber Mop Pad - 24"/ 60 cm - Dry - Yellow/ "M-Tech" Tampon de vadrouille plate en microfibre avec velcro 24"/60 cm - sec -jaune				12/1	\$ 28.85
MFP-V4236-YE	M-Tech Velcro Flat Microfiber Mop Pad - 36"/ 92 cm - Dry - Yellow / "M-Tech" Tampon de vadrouille plate en microfibre avec velcro 36"/92 cm - sec -jaune				12/1	\$ 44.57

18"/45 CM MICROFIBER VELCRO FRAME / CHÂSSIS POUR MICROFIBRE VELCRO 18"/45 CM

The MicroFiber Velcro Aluminum Frame has a trapezoid shape designed for corners. It has a 360° degree swivel head which allows for easier movement of frame on the floor. Interlocking collar allows for most types of handles.

Le châssis velcro en aluminium pour microfibre a une forme de trapèze conçu pour les coins. Il possède une tête pivotante sur 360 qui facilite les mouvements du châssis sur le plancher. Le collet d'emboîtement accepte le plus part des types de manches



Swivel Head /
Tete pivotante

VELCRO FRAMES/ CADRE POUR VELCRO



10"
25 CM



16"
40 CM



18"
45 CM



24"
60 CM



40"
100 CM



Closed 39" / 100cm - Extended 70" / 180cm



FH-A3180

M2 Code Code M2	Description	Pack Wt LB (S) Poids (lb) (S)	Pack Wt KG Poids (kg)	Cubic Ft Pi3	Pack Contenu	List Price Liste des prix
MFF-7410	Velcro Frame Only 10" / 25 cm / Cadre pour Velcro seulement 10 po / 25 cm				10/1	\$ 29.90
MFF-7416	Velcro Frame Only 16" / 40 cm / Cadre pour Velcro seulement 16 po / 40 cm	10.4	4.7		10/1	\$ 29.90
MFF-7418	Velcro Frame Only 18" / 45 cm / Cadre pour Velcro seulement 18 po / 45 cm	11	5		10/1	\$ 35.62
MFF-7424	Velcro Frame Only 24" / 60 cm / Cadre pour Velcro seulement 24 po / 60 cm	13.7	6.2		10/1	\$ 40.82
MFF-7436	Velcro Frame Only 36" / 91 cm / Cadre pour Velcro seulement 36 po / 100 cm	24.5	11		10/1	\$ 56.43
TELESCOPIC NON THREADED HANDLE / MANCHE TÉLESCOPIQUE NON FILETÉ						
FH-A3180	Telescopic Non Threaded Handle - 39"-70"-100cm-180 cm / Manche télescopique non fileté 39"-70"-100cm-180 cm				20/1	\$ 20.97



**1 18" / 45 CM SWIPE-IT VELCRO FRAME KIT WITH BLUE M-FIBRE PAD /
18" / 45 CM CADRE "SWIPE-IT" VELCRO AVEC TAMPON BLEU MICROFIBRE**



INCLUDES:

- 18" / 45 cm Blue M-Fibre, Velcro Flat Pad
- 18" / 45 cm Velcro Frame
- Telescopic Metal Handle - 39" - 70" / 100 - 180 cm

COMPREND:

- 18" / 45 cm Vadrouille en microfibre
- 18" / 45 cm Cadre pour Velcro
- Manche télescopique fileté - 39 - 70 po / 100 - 180 cm



M2 Code Code M2	Description	Pack Wt LB (S) Poids (lb) (S)	Pack Wt KG Poids (kg)	Cubic Ft Pi3	Pack Contenu	List Price Liste des prix
MFK-V50018	Swipe-It Velcro Frame Kit/w/18" Blue M-Fibre Pad, Velcro Frame & Telescopic Handle / Ensemble de Tampons Swipe it avec cadre Velcro /18 pouces bleu manche télescopique				1	\$ 54.45

**2 16" / 40 CM AND 18" / 45 CM SWIPE-IT M-TECK MICROSTRIP KIT /
ENSEMBLE COMPLET EN VELCRO 16 PO 40 CM "MICROSTRIP"**



INCLUDES:

- 16" / 40 cm or 18" / 45 cm MicroStrip Microfiber pad.
- 16" / 40 cm or 18" / 45 cm Velcro Frame
- Telescopic Metal Handle - 39" - 70" / 100 - 180 cm

COMPREND:

- 16" / 40 cm ou 18" / 45 cm Tampon Velcro en microfibre pour MicroStrip
- 16" / 40 cm ou 18" / 45 cm Cadre pour Velcro
- Manche télescopique fileté - 39 - 70 po / 100 - 180 cm



M2 Code Code M2	Description	Pack Wt LB (S) Poids (lb) (S)	Pack Wt KG Poids (kg)	Cubic Ft Pi3	Pack Contenu	List Price Liste des prix
MFK-V60016	Velcro Frame Kit with 16" / 40 cm MicroStrip 16" / 40 cm Pad & Telescopic Handle / Cadre pour Velcro seulement 16 po / 40 cm "MicroStrip" 16 po / 40 cm blanc/rayures/Manche télescopique				10/1	\$ 61.25
MFK-V7418-Kit	Swipe-It Velcro Frame Kit with 18" / 45 cm Micro Strip Pad & Telescopic Locking Adapter / Cadre pour Velcro seulement Swipe-It 18 po / 45 cm "M-Tech" 18 po / 45 cm rayures/Adaptateur de verrouillage télescopique				10/1	\$ 62.51

**3 16" / 40 CM M-TECK MICRO PET KIT /
ENSEMBLE COMPLET EN VELCRO 16 PO 40 CM "MICRO PET"**



INCLUDES:

- 16" / 40 cm Micro PET, Velcro Flat Microfiber Pad
- 16" / 40 cm Velcro Frame
- Telescopic Metal Handle - 39" - 70" / 100 - 180 cm

COMPREND:

- 16" / 40 cm Vadrouille en microfibre Micro-Pet
- 16" / 40 cm Cadre pour Velcro
- 16" / 40 cm Manche télescopique fileté - 39 - 70 po / 100 - 180 cm



M2 Code Code M2	Description	Pack Wt LB (S) Poids (lb) (S)	Pack Wt KG Poids (kg)	Cubic Ft Pi3	Pack Contenu	List Price Liste des prix
MFK-V80016	Velcro Frame Kit with 16" / 40 cm Micro PET 16" / 40 cm Pad & Telescopic Handle / Cadre pour Velcro seulement 16 po / 40 cm "Micro PET" 16 po / 40 cm rayures/Manche télescopique				10/1	\$ 65.54

4 16"/40 CM M-TECH MICROFIBER KIT / ENSEMBLE COMPLET EN VELCRO 16 PO 40 CM "M-TECH"



INCLUDES:

- 16" / 40 cm M-Tech Velcro Flat Microfiber Mop Pad - Grey
- 16" / 40 cm Velcro Frame
- 16" / 40 cm Telescopic Metal Handle - 39" - 70" / 100 - 180 cm

COMPREND:

- 16" / 40 cm "M-Tech" Tampon de vadrouille plate en microfibre avec velcro - gris
- 16" / 40 cm Cadre pour Velcro
- 16" / 40 cm Manche télescopique fileté - 39 - 70 po / 100 - 180 cm



M2 Code Code M2	Description	Pack Wt LB (S) Poids (lb) (S)	Pack Wt KG Poids (kg)	Cubic Ft Pi3	Pack Contenu	List Price Liste des prix
MFK-V70016	Velcro Frame Ki with 16" / 40 cm M-Tech 16" / 40 cm Pad & Telescopic Handle / Cadre pour Velcro seulement 16 po / 40 cm "M-Tech" 16 po / 40 cm rayures/Manche télescopique				10/1	\$ 67.96

5 18"/45 CM SWIPE-IT VELCRO FRAME KIT WITH MICRO FIBRE DRYPAD WITH FRINGE / 18" /45 CM CADRE "SWIPE-IT" VELCRO AVEC TAMPON MICROFIBRE SEC AVEC FRANGE



INCLUDES:

- 18" / 45 cm Micro Fibre DryPad with Fringe
- 18" / 45 cm Velcro Frame
- Telescopic Metal Handle - 39" - 70" / 100 - 180 cm

COMPREND:

- 18" / 40 cm Vadrouille en microfibre
- 18" / 45 cm Cadre pour Velcro
- Manche télescopique fileté - 39 - 70 po / 100 - 180 cm



MFK-V90018	Swipe-It Velcro Frame Kit/w/18" Micro-Fibre DryPad/w Fringe, Velcro Frame & Telescopic Handle / Ensemble de Tampons pour le sec Swipe it avec cadre Velcro /18 pouces bleu manche télescopique				1	\$ 65.68
------------	--	--	--	--	---	----------



RT-FM-9250	Flat Mop with Handle / Vadrouille plate avec manche				12	\$ 33.55
RT-FM-9251	Flat Mop Refill Only / Rechange de vadrouille plate				12	\$ 10.35



SPRAY XPRESS FLOOR & WAXING TOOL / VAPORISATEUR POUR PLANCHER ET OUTIL DE CIRAGE



32 OZ / 946 ML
BOTTLE CAPACITY /
LA CAPACITÉ DE LA
BOUTEILLE

To be used with Velcro frame /
À utiliser avec le cadre "Velcro"



INTENSE DUSTING CLEANING AND MOPPING / TAMPON À POUSSIÈRE ET VADROUILLE DE NETTOYAGE

This microfiber pad used for general cleaning and wet mopping in high traffic areas. The Microfiber yarn is washable up to 800 times and can be used wet or dry. Low friction with no drag can mechanically clean with minimal chemical use.

Ce tampon en microfibre est utilisé pour le nettoyage général et le lavage dans les zones à fort trafic. Les fibres de microfibre sont lavables jusqu'à 800 fois et peuvent être utilisées humide ou sec. Le faible frottement, sans glissement peut nettoyer mécaniquement avec une utilisation minimale de produits chimiques.

INTENSE WET CLEANING PADS / TAMPONS DE NETTOYAGE INTENSE

This micro fiber pad allows you to dust and wet mop. Microfiber yarn is washable can be used wet or dry. Low friction with no drag can mechanically clean with minimal chemical use.

Ce tampon en microfibre vous permet d'enlever la poussière et nettoyer. La microfibre est lavable et peut être utilisée humide ou sec. Le faible frottement, sans glissement peut nettoyer mécaniquement avec une utilisation minimale de produits chimiques.

WAXING / CIRAGE

are recommended for use with burnished floor finishes. Les vadrouilles "glacier" sont recommandées pour une utilisation avec des finitions de plancher lustré.

M2 Code Code M2	Description	Pack Wt LB (S) Poids (lb) (S)	Pack Wt KG Poids (kg)	Cubic Ft Pi3	Pack Contenu	List Price Liste des prix
SE-9000	Spray Xpress Floor Mop Tool / Outil pour vadrouille Spray express pour plancher	4	1.81	.63	1	\$ 209.93
MFP-V4216-BL	M-Tech Velcro Flat Microfiber Mop Pad - 16" / 40 cm - Blue - Wet "M-Tech" Tampon de vadrouille plate en microfibre avec velcro - 16" / 40 cm - sec - bleu				10/1	\$ 21.49
MFP-V5216-GY	M-Tech Velcro Flat Microfiber Mop Pad - 16" / 40 cm - Grey - Dry "M-Tech" Tampon de vadrouille plate en microfibre avec velcro - 16" / 40 cm - humide - gris				10/1	\$ 21.49
DM-WV516	Glacier Nylon Velcro MopPad - 5" x 16" / 13 x 40 cm Vadrouilles à poussière en nylon "Glacier", 5 x 16" / 40 cm x 13 cm - Velcro				12/1	\$ 19.87

DUO MICROFIBER SYSTEM / SYSTÈME DOUBLE FACE EN MICROFIBRE



M2 Code Code M2	Description	Pack Wt LB (S) Poids (lb) (S)	Pack Wt KG Poids (kg)	Cubic Ft Pi3	Pack Contenu	List Price Liste des prix
FM-P1000	Duo Frame - 40cm/16" / Cadre double, 40cm / 16 po	8	3.6	.5	10/1	\$ 21.21
FM-P1001	Duo Microfiber Mop - Blue - 40cm/16" / Vadrouille double face en microfibre, bleu, 40 cm / 16 po	8.5	4	1.5	10/1	\$ 12.49

STATIC ATTACK

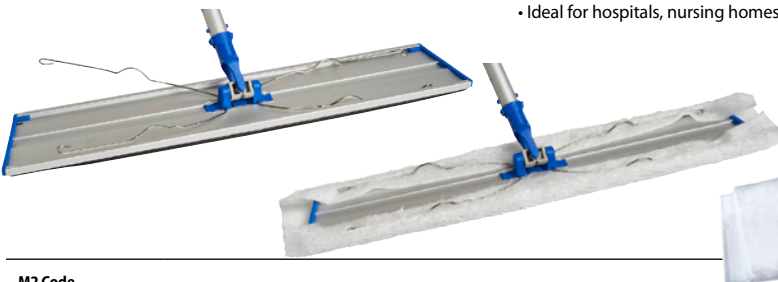

M2's Static Attack sheets use an electrostatic charge to attract fine dust and particles. Ideal in facilities where cross-contamination is a concern, One sheet per room is recommended.

• Ideal for hospitals, nursing homes, office buildings, classrooms and stores. • Eliminates the need for laundering

Les feuilles de "Static Attack" de M2 utilisent une charge électrostatique pour attirer la poussière fine et les particules. Idéal dans les installations où la contamination croisée est une préoccupation. Une feuille par pièce est recommandée.

• Idéal pour les hôpitaux, les maisons de soins infirmiers, les immeubles de bureaux, les salles de classe et les magasins.
• Élimine le besoin de laver.

M2 Code Code M2	Description	Pack Wt LB (S) Poids (lb) (S)	Pack Wt KG Poids (kg)	Cubic Ft Pi3	Pack Contenu	List Price Liste des prix
STA-2368	Static Attack Mop Sheets - 23.6" x 8" - 200 per case / Feuilles pour vadrouille "Static Attack" 200 par caisse				200/1	\$ 216.91
STA-2369	24"/60 cm Static Attack Frame / Cadre de vadrouille "Static Attack" - 24"/60 cm				1	\$ 100.20
STA-2370	"Static Attack" Mop Frame 24" and Aluminum Telescopic Handle (Closed 39"-100 cm - Ext. 71"-180 cm)				1	\$ 115.40
STA-2371	"Static Attack" Mop Frame 47" / 120 cm and Aluminum Telescopic Handle (Closed 71"-180 cm)				1	\$ 392.95
TELESCOPIC ALUMINUM HANDLE - NON THREADED / MANCHE TÉLESCOPIQUE EN ALUMINIUM						
FH-A3180	Telescopic Non Threaded Handle - 100 -180 cm / Manche télescopique non fileté 100"/180 cm				20/1	\$ 20.97



COLLAPSIBLE FLAT MOPPING SYSTEM / SYSTÈME DE VADROUILLE PLATE PLIANTE

THE OLYMPIC FRAME / LE CHÂSSIS OLYMPIC

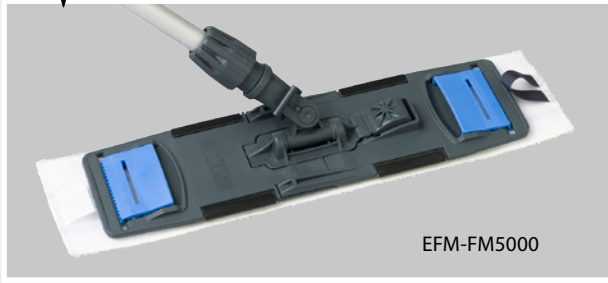

EFM-FM5000



**IDEAL FOR HEALTHCARE MARKET /
IDÉAL POUR LE MARCHÉ DES SOINS DE SANTÉ**



The Olympic frame has been designed and created for different cleaning areas and to be used in different ways, depending on customer needs. It adapts itself to any mop or cloth on the market.

Olympic is equipped with removable and replaceable Velcro. The opening - closing allows the operator to avoid touching the dirty mop after use, thus guaranteeing maximum hygiene and safety.

Le châssis Olympic a été conçu et créé pour différentes zones de nettoyage et pour être utilisé de différentes façons, dépendant des besoins des clients. Il s'adapte à plusieurs tampons ou chiffons sur le marché.

Olympic est équipé d'un velcro amovible et remplaçable. L'ouverture/fermeture permet à l'opérateur d'éviter de toucher le tampon souillé après usage, de même il garantit un maximum d'hygiène et de sécurité.

POCKET STYLE / STYLE POCHE



STEP 1 / ÉTAPE 1

Pick up mop from Presoaked MopBox
Retirer le tampon du baquet de
Pré-trempage



STEP 2 / ÉTAPE 2

Wash floor or patient room
Laver le plancher ou la chambre
du patient



STEP 3 / ÉTAPE 3

Step on clip to collapse frame
Marcher sur l'attache pour plier
le châssis



STEP 4 / ÉTAPE 4

Drop mop pad into laundry bag
Jeter le tampon dans le sac de
lavage

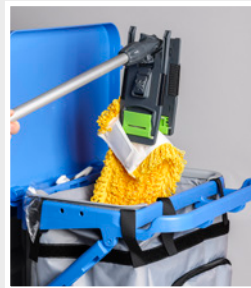

Olympic frame and Microloop mop are also ideal for washing walls

Le châssis Olympic et le tampon "Microloop" sont aussi idéals pour le lavage des murs.

**TAB STYLE COLLAPSIBLE SYSTEM /
SYSTÈME PLIANT À LANGUETTES**



MOPPADS / TAMPONS

ALL OUR MOPPAD REFILLS ARE AVAILABLE IN TAB, VELCRO, POCKET AND T-TAB STYLES /

TOUS NOS RECHANGES DE TAMPONS SONT DISPONIBLES DANS LE STYLE LANGUETTE, VELCRO, POCHE ET LANGUETTE EN T



MICROLOOP

Mainly used for wet mopping in medium/highly soiled floors these refills are environmentally friendly requiring less chemicals
Constructed with durable backing and long lasting microfiber yarn for the toughest jobs and repeated launderings. The microfiber yarn allows for better liquid retention and better floor coverage. It can withstand hundreds of launderings.

MICROLOOP

Principalement utilisés pour le nettoyage humide sur les planchers de moyennement à hautement souillés ces tampons de rechange sont respectueux de l'environnement et requiert moins de produits chimiques..
Bâtit avec un endos durable et des fils de microfibre durables pour les gros travaux et les lavages répétés. Le codage de couleur des fils de microfibre permet une meilleure rétention des liquides et une meilleure couverture du sol. Ils peuvent supporter des centaines de lavages.

**IDEAL FOR HEALTHCARE MARKET /
IDÉAL POUR LE MARCHÉ DES SOINS DE SANTÉ**



EFM-FM5000

Closed 39" / 100cm - Extended 70" / 180cm



FH-A3180



M2 Code Code M2	Description	Pack Wt LB (S) Poids (lb) (S)	Pack Wt KG Poids (kg)	Cubic Ft Pi3	Pack Contenu	List Price Liste des prix
EFM-FM5000	Olympic Flat Mop Frame Only Blue Clips / Cadre Olympic pour vadrouille plate seulement attaches bleus	.9	.4		10/1	\$ 43.57
EFM-FM5100-BL	Flat Mop Looped MicroLoop fiber refill 16"/40cm Blue w/Tabs / Rechange de vadrouille plate en microfibre bouclée 16"/40cm bleu avec attaches	12.8	6		10/1	\$ 26.35
EFM-FM5100-RD	Flat Mop Looped MicroLoop fiber refill 16"/40cm Red w/Tabs / Rechange de vadrouille plate en microfibre bouclée 16"/40cm rouge avec attaches	12.8	6		10/1	\$ 26.35
EFM-FM5100-YE	Flat Mop Looped MicroLoop fiber refill 16"/40cm Yellow w/Tabs / Rechange de vadrouille plate en microfibre bouclée 16"/40cm jaune avec attaches	12.8	6		10/1	\$ 26.35
EFM-FM5100-GN	Flat Mop Looped MicroLoop fiber refill 16"/40cm Green w/Tabs / Rechange de vadrouille plate en microfibre bouclée 16"/40cm vert avec attaches	12.8	6		10/1	\$ 26.35
EFM-FM5100-WH	Flat Mop Looped MicroLoop fiber refill 16"/40cm White w/Tabs / Rechange de vadrouille plate en microfibre bouclée 16"/40cm blanc avec attaches	12.8	6		10/1	\$ 26.35
EFM-FM5100-GR	Flat Mop Looped MicroLoop fiber refill 16"/40cm Grey w/Tabs / Rechange de vadrouille plate en microfibre bouclée 16"/40cm Gris avec attaches	12.8	6		10/1	\$ 26.35
TELESCOPIC NON THREADED HANDLE / MANCHE TÉLESCOPIQUE NON FILETÉ						
FH-A3180	Telescopic Non Threaded Handle - 39"- 70"-100cm-180 cm / Manche télescopique non fileté 39"- 70"-100cm-180 cm				20/1	\$ 20.97

MOPPADS / TAMPONS

EFM-FM5200



EFM-FM54016



EFM-FMT64516-T



EFM-FMT64616-T



EFM-FMT64616



TREO LOOP (3)

Treo loop flat mop pad is an all-purpose flat mop that has improved cleaning performance and long launderability

- Can be laundered 600 times at 90° C/194 °F – Three types of yarn

TREO LOOP (3)

Le tampon plat "Treo loop" est un tampon tous-usages qui a amélioré les performances de nettoyage et la résistance aux lavages.

- Peut être lavé 600 fois à 90 C/194 F – Trois type de fils

MICRO SCRUB

Micro Scrub is ideal for both wet and dry cleaning. Especially on sticky floors. Cleaning and disinfecting takes place after the mop is presoaked with water mixed with diluted detergents

MICRO SCRUB

Le tampon "Micro Scrub" est idéal à la fois pour le nettoyage sec ou humide, spécialement sur les sols adhérents. Le nettoyage et la désinfection commence après que le tampon est pré-trempé dans de l'eau mélangée avec un détergent dilué.



EFM-FM6100-WH



Available in all colours
Ask your representative



M2 Code Code M2	Description	Pack Wt LB (S) Poids (lb) (S)	Pack Wt KG Poids (kg)	Cubic Ft Pi3	Pack Contenu	List Price Liste des prix
EFM-FM5200	Microfiber Treo Loop w/Tabs N/Pockets / Microfibre Treo Loop w/Tabs N/Pockets Rechange de tampon de microfibre "Treo Loop" avec attaches pas de pochette	14.5	6.7		10/1	\$ 19.92
EFM-FM54016	Flat Mop Micro Scrub microfiber Pads refill 40cm/16" White/Green w/Tabs / Rechange de tampon microfibre pour vadrouille plate "Micro Scrub" 40cm/16" blanc/vert avec attaches	15.4	7		10/1	\$ 14.14
EFM-FM5200-T	Microfiber Treo Loop with T/Tabs / Rechange de tampon en microfibre "Treo Loop" avec attaches en T				10/1	\$ 19.92
EFM-FMT64516-T	Flat Mop MicroStrip MicroFiber Pad 40cm/16" white/w stripe With T/Tabs or Pockets / Tampon Velcro en microfibre pour vadrouille plate "MicroStrip" – 40cm/16" blanc/ rayures				10/1	\$ 18.32
EFM-FMT64616-T	Flat Mop MicroLight MicroFiber Pad 40cm/16" white/w Blue stripe With T/Tabs or Pockets / Tampon Velcro en microfibre pour vadrouille plate "MicroStrip" 40cm/16" blanc/ rayures				10/1	\$ 14.03
EFM-FMT64616-T	Flat Mop MicroLight MicroFiber Pad Refill 40cm/16" white/w Blue stripe With T/Tabs or Pockets / Tampon Velcro en microfibre pour vadrouille plate "MicroStrip" 40cm/16" blanc/ rayures				10/1	\$ 18.52
EFM-FM6100-BL	Flat Mop Looped MicroTech fiber refill 40cm/16" Blue w/Tabs OR/Pockets / Recharge de vadrouille plate en microfibre bouclée 40cm/16" Bleu avec attaches				10/1	\$ 18.82
EFM-FM6100-RD	Flat Mop Looped MicroTech fiber refill 40cm/16" Red w/Tabs OR/Pockets / Recharge de vadrouille plate en microfibre bouclée 40cm/16" Rouge avec attaches				10/1	\$ 18.82
EFM-FM6100-YE	Flat Mop Looped MicroTech fiber refill 40cm/16" Yellow/Tabs OR/Pockets / Recharge de vadrouille plate en microfibre bouclée 40cm/16" Jaune avec attaches				10/1	\$ 18.52
EFM-FM6100-WH	Flat Mop Looped MicroTech fiber refill 40cm/16" White w/Tabs OR/Pockets / Recharge de vadrouille plate en microfibre bouclée 40cm/16" blanc avec attaches				10/1	\$ 18.52
EFM-FM6100-WH	Flat Mop Looped MicroTech fiber refill 40cm/16" White w/Tabs OR/Pockets / Recharge de vadrouille plate en microfibre bouclée 40cm/16" Blanc avec attaches				10/1	\$ 16.50

DISPOSABLE MICROFIBER PADS



FLD-200

18" x 5" / 45 x 13 cm Disposable Healthcare Microfiber Pad

50/Bag
50 Bags/Box
500 Each
\$ 66.36

FLD-300

18" x 5" / 45 x 13 cm Disposable Microfiber Pad with Blue Scrub Stripe

50/Bag
50 Bags/Box
500 Each
\$ 37.58



ENTRY LEVEL FLAT MOPPING SYSTEM / SYSTÈME DE SEAU POUR VADROUILLE PLATE



Drain valve to release dirty water
Un drain de vidange pour libérer l'eau sale.

**COMPLETE -
ALL IN ONE BOX /**

**COMPLÈT - BOÎTE TOUT-
EN-UN**



16 QT/15 L / 16 PTES/15 L



1. Dip mop in clean water
2. Clean Floor

1. Tremper la vadrouille dans l'eau propre
2. Nettoyer le plancher



3. Dip in dirty water
4. Wring out

3. Tremper dans l'eau souillée
4. Essorer



4. Repeat / Répéter

- Double bucket is made with a unique Polypro material that has two compartments for clean and dirty water
- It is strong and long lasting and easier to keep clean
- Light weight and durable construction has 3" quiet rolling wheels
- Double bucket with wringer is light weight and easy to carry in and out of office or car
- Double bucket system ensures less cross-contamination as a result of using cleaner water longer

- Le seau double est fait d'un matériel de polypro unique et a deux compartiments pour l'eau propre et souillé.
- Il est robuste et durable et facile à garder propre.
- Il peut accommoder deux types d'essoreuse, l'essoreuse descendante jr. ou l'essoreuse à rouleaux.
- Le double seau avecessoreuse est léger et facile à transporter au bureau ou vers la voiture.
- Le système doubles seaux assure moins de contamination croisée, résultat de l'utilisation de l'eau propre plus longtemps.

M2 Code Code M2	Description	Pack Wt LB (S) Poids (lb) (S)	Pack Wt KG Poids (kg)	Cubic Ft PI3	Pack Contenu	List Price Liste des prix
EFM-DB4510	MicroFiber Starter Kit Inc. (Double Bucket w/Drain /w Speed Wringer Inc. frame handle and refill) / Trousse de départ - inclus, Seau double avec drain,essoreuse ("speed wringer"), châssis, manche et recharge de vadrouille plate	12.5	5.6		1	\$ 349.35
EFM-DB4500	Double Bucket w/Drain /w Speed Wringer - Blue / Seau double avec drain etessoreuse ("Speed Wringer") - bleu	6.7	3		1	\$ 290.08



**16 QT/15 L
16 PTES/15 L**

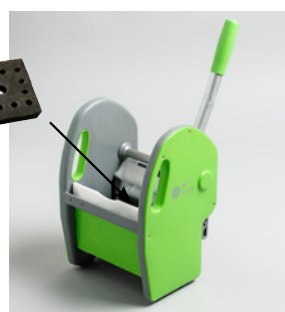

Double Buck

- Made with Polypro material with two compartments for clean and dirty water
- Can accommodate two types of wringers - Jr. Down Press or Roller Wringer
- Ensures less cross-contamination

Double seau 0.0125 in-

- Fabriqué avec un matériau polypropylène unique avec deux compartiments pour l'eau propre et sale.
- Peut accueillir deux types d'essoreuse - Descendante Jr. ouessoreuse à rouleaux.
- Assure moins de contamination croisée.

Roller Wringer

- Best for wringing out microfiber Spin-n-drop system
 - Light weight but strong construction
 - Roller with handle optimizes wringing efficiency
 - Fits both double bucket and single buckets
 - Consistent wringing action with less effort
- Essoreuse à rouleau**
- Le meilleur pour essorer les microfibrés du système "Spin n drop"
 - Elle est légère mais de construction robuste
 - Le rouleau et le manche optimisent l'efficacité de l'essorage
 - S'adapte aussi bien au seau double comme au seau simple
 - Très grande action d'essorage avec moins d'effort

M2 Jr. Down Press Wringer

- Can wring out Spin-n-drop mops with the Wringer Insert
 - Light weight but strong construction
 - Jaw pressure plates grab and force water into the bucket
 - Less force than traditional side press wringers
 - Fits both double bucket and single buckets
- L'essoreuse descendante M2 Jr.**
- Peut essorer les tampons "spin-n-drop" avec l'ajout de l'insertion
 - Légère mais de construction robuste
 - La mâchoire de la plaque de pression saisit et dirige l'eau dans le seau
 - Utilise moins de force qu'uneessoreuse latérale traditionnelle
 - S'adapte aussi bien au seau double comme au seau simple

EFM-DB3500	Double Bucket Only with Wheels Including Wringer Support - Green / Double seau seulement avec roues et support d'essoreuse - vert				1	\$188.93
EFM-RW3501	Roller Wringer Only - Green / Essoreuse à rouleau seulement - vert	7	3.2		1	\$ 267.68
EFM-DP3510	Jr Down Press Wringer Only - Green / Essoreuse descendante Jr. seulement - vert	5.2	2.3		1	\$ 163.74
EFM-DB3500 + EFM-RW3501	Double Bucket Only with Wheels Including Wringer Support - Green and Roller Wringer Green /				1	\$467.01
EFM-DP3511	Jr Down Press Wringer Insert / Insertion pouressoreuse descendante Jr.	.06	.03		10/1	\$ 32.86

TOP DOWN CHARGING BUCKET TROLLEYS / CHARIOT DE SEAU - CHARGE DE HAUT EN BAS

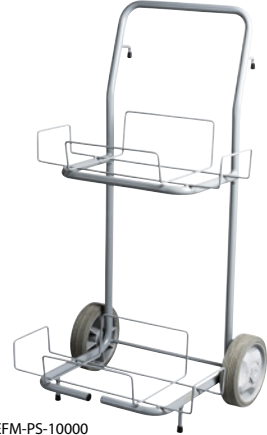

EFM-PS-10000



EFM-PS-10010

- Made of strong resilient tubing that carries up to 3 mopboxes of any size
- Mop handle connector included
- Large durable wheels
- Fait de tube résilient robuste qui peut porter jusqu'à 3 baquets de pré-trempage de toutes tailles
- Connecteur de manche à vadrouille inclus
- Grandes roues durables

M2 Code Code M2	Description	Pack Wt LB (S) Poids (lb) (S)	Pack Wt KG Poids (kg)	Cubic Ft Pi³	Pack Contenu	List Price Liste des prix
EFM-PS-10000	PreSoak Trolley Only - Small / Petit chariot de pré-trempage seulement	15.7	7.1		1	\$ 313.67
EFM-PS-10010	PreSoak Trolley Only - Medium/ Moyen chariot de pré-trempage seulement				1	\$ 1,124.81

TOP DOWN PRESOAKING HERMETIC/CHARGING BUCKETS / BAQUETS DE PRÉ-TREMPAGE HERMÉTIQUES - CHARGE DE HAUT EN BAS

- Ideal for presoaking your microfiber pads for cleaning or disinfecting
- Buckets have a water tight lid to keep all mops moist and sealed
- Charging buckets have measuring marks in both litres and gallons
- A strong finger grip carrying handle to carry by hand or optional wheels for rolling

- Idéal pour pré-tremper les tampons de microfibre pour le nettoyage et la désinfection
- Les baquets ont un couvert étanche pour garder les tampons humide et scellés.
- Les baquets ont des marques de mesure en litres et en gallons.
- Une robuste poignée adhérente pour transporter manuellement ou en option des roues pour les rouler.

25 L / 6 US GALLON CAPACITY / CAPACITÉ
WATERTIGHT SEAL / JOINT ÉTANCHE À L'EAU



M2 Code Code M2	Description	Pack Wt LB (S) Poids (lb) (S)	Pack Wt KG Poids (kg)	Cubic Ft Pi³	Pack Contenu	List Price Liste des prix
EFM-PS-10100-BL	Presoak Bucket - Blue / Seau de pré-trempage - bleu	2.8	1.3		10/1	\$ 45.64
EFM-PS-10101-BL	Presoak Bucket Lid - Blue / Couverture pour seau de pré-trempage - bleu	1.4	.65		10/1	\$ 24.38
EFM-PS-10102-RD	Presoak Bucket - Red / Seau de pré-trempage - rouge	2.8	1.3		10/1	\$ 45.64
EFM-PS-10103-RD	Presoak Bucket Lid- Red / Couverture pour seau de pré-trempage - rouge	1.4	.65		10/1	\$ 24.38
EFM-PS-10104	Presoak Bucket Wheels Only (Set of 4) / Roues pour seau de pré-trempage seulement (pq de 4)				1	\$ 27.20

STEPS TO CHARGE OR PRESOAK YOUR MOPPADS / ÉTAPE POUR CHARGER OU PRÉ-TEMPIER VOS TAMPONS



Step 1: Load 15-20 mops in the bucket
Étape 1: Charger les tampons dans le baquet



Step 2: Pour in the prepared solution
Étape 2: Insérer la solution préparée



Step 3: Close the lid
Étape 3: Fermer le couvert



Step 4: Flip the bucket to saturate the mops thoroughly
Étape 4: Renverser le baquet pour saturer les tampons complètement.



FOODSERVICE SERVICE ALIMENTAIRE

FOOD PROCESSING / LA TRANSFORMATION DES ALIMENTS HACCP



HYGIENE PRODUCTS

M2 Professional Food Processing Products – are a range of products to satisfy the specific demands of food and professional hygiene processing.

M2 Professional Food Processing Product range is in compliance with the restricted standards set out by F.E.I.B.P. (European Brushware Federation), that meet the requirements of the following international standards:

- HACCP (Hazard Analysis of Critical Control Points) developed by the US Department of Agriculture. HACCP is a prevention-based system developed to help the food industry identify weak points or situations in order to prevent and/or reduce food contamination.
- EC Food Hygiene Directive (1993).
- US Public Health Service Food Code (1993).

PRODUITS D'HYGIÈNE

La gamme de produits de transformation des aliments de M2 Professional est conçue pour satisfaire les exigences spécifiques en matière d'hygiène dans l'industrie alimentaire et les secteurs professionnels.

La gamme de produits M2 Professional est en conformité avec les normes réglementées définies par F.E.I.B.P. (European Brushware Federation), qui répondent aux exigences des normes internationales suivantes:

- HACCP (Analyse des risques et maîtrise des points critiques) développé par le département américain de l'agriculture. HACCP est un système axé sur la prévention développés pour aider l'industrie alimentaire à identifier les points faibles ou des situation en vue de prévenir et/ou réduire la contamination des aliments.
- Directives de la CE sur l'hygiène alimentaire (1993)
- Code alimentaire du service de santé publique américain (1993)



SHIPPING / LIVRAISON

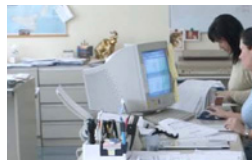

PACKAGING /
EMBALLAGE

HACCP COLOUR PROGRAM PROGRAMME DE COULEUR HACCP



WAREHOUSE / RECEIVING
ENTREPÔT / RÉCEPTION

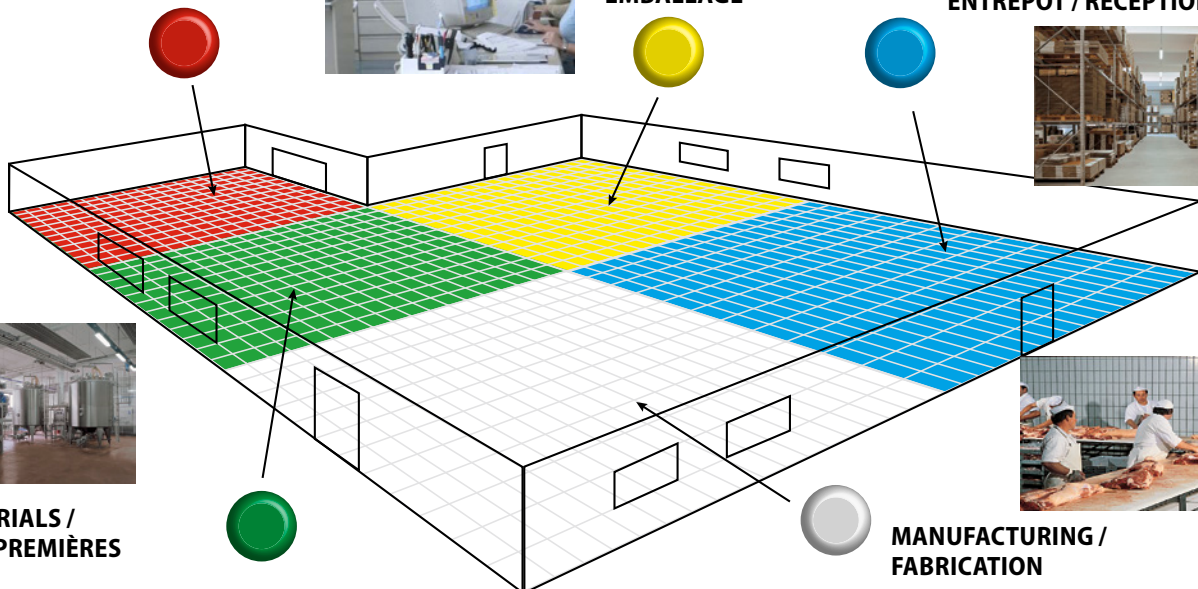

RAW MATERIALS /
MATIÈRES PREMIÈRES



MANUFACTURING /
FABRICATION

FOODSERVICE PUSHBROOMS & HANDLES BALAI-POUSSOIR D'ALIMENTATION ET MANCHES

Our unique pushbrooms are manufactured with highest quality fibers that are inset in an easy-to-clean and "wood-free" plastic block that resists bacteria to meet hygienic regulations.

Our Foodservice pushbrooms were designed for usage with many strong floor degreasers and for abrasive scrubbing.

- They can be washed to extend performance life.
- Colour coded to identify specific cleaning areas
- Takes a standard acme threaded handle

Nos balais-poussoir uniques sont fabriqués avec des fibres de haute qualité qui sont incrustées dans un format facile à nettoyer et un bloc en plastique sans bois qui résiste aux bactéries et respecte la réglementation en matière d'hygiène.

Nos balais-poussoir d'alimentation ont été conçus pour une utilisation avec de nombreux dégraissants de sol puissants et pour le nettoyage abrasif et peuvent être lavés pour prolonger la durée de la performance.

- Ils peuvent lavé pour prolonger la vie de la performance.
- Code de couleur pour identifier les domaines spécifiques de nettoyage.
- Utilise un manche fileté acmé standard



18"/45CM
24"/60CM

M2 Code Code M2	Description	Pack Wt LB (S) Poids (lb) (S)	Pack Wt KG Poids (kg)	Cubic Ft Pi3	Pack Contenu	List Price Liste des prix
18" / 45cm						
PB-FS18-BK	Foodservice PushBroom 18" / 45 cm - Black / Balai-Poussoir d'alimentation 18" / 45 cm - noir	18	8.3		10/1	\$ 25.22
PB-FS18-WH	Foodservice PushBroom 18" / 45 cm - White / Balai-Poussoir d'alimentation 18" / 45 cm - blanc	18	8.3		10/1	\$ 25.22
PB-FS18-GN	Foodservice PushBroom 18" / 45 cm - Green / Balai-Poussoir d'alimentation 18" / 45 cm - vert	18	8.3		10/1	\$ 25.22
PB-FS18-BL	Foodservice PushBroom 18" / 45 cm - Blue / Balai-Poussoir d'alimentation 18" / 45 cm - bleu	18	8.3		10/1	\$ 25.22
PB-FS18-RD	Foodservice PushBroom 18" / 45 cm - Red / Balai-Poussoir d'alimentation 18" / 45 cm - rouge	18	8.3		10/1	\$ 25.22
PB-FS18-YE	Foodservice PushBroom 18" / 45 cm - Yellow / Balai-Poussoir d'alimentation 18" / 45 cm - jaune	18	8.3		10/1	\$ 25.22
24" / 60cm						
PB-FS24-BK	Foodservice PushBroom 24" / 60cm - Black / Balai-Poussoir d'alimentation 24" / 60cm - noir	21	9.5		10/1	\$ 32.07
PB-FS24-WH	Foodservice PushBroom 24" / 60cm - White / Balai-Poussoir d'alimentation 24" / 60cm - blanc	21	9.5		10/1	\$ 32.07
PB-FS24-GN	Foodservice PushBroom 24" / 60cm - Green / Balai-Poussoir d'alimentation 24" / 60cm - vert	21	9.5		10/1	\$ 32.07
PB-FS24-BL	Foodservice PushBroom 24" / 60cm - Blue / Balai-Poussoir d'alimentation 24" / 60cm - bleu	21	9.5		10/1	\$ 32.07
PB-FS24-RD	Foodservice PushBroom 24" / 60cm - Red / Balai-Poussoir d'alimentation 24" / 60cm - rouge	21	9.5		10/1	\$ 32.07
PB-FS24-YE	Foodservice PushBroom 24" / 60cm - Yellow / Balai-Poussoir d'alimentation 24" / 60cm - jaune	21	9.5		10/1	\$ 32.07



FOODSERVICE TOOLHOLDER / PORTE-OUTILS D'ALIMENTATION

M2 Code Code M2	Description	Pack Wt LB (S) Poids (lb) (S)	Pack Wt KG Poids (kg)	Cubic Ft Pi3	Pack Contenu	List Price Liste des prix
FP-TL9110	10" Aluminum Tool Holder/Hanger Blue, Red, Green, Yellow, White Porte-outils en aluminium 10" Bleu, rouge, vert, jaune, blanc				6/1	\$ 22.04



FOODSERVICE FIBERGLASS HANDLES / MANCHES EN FIBRE DE VERRE POUR L'ALIMENTATION

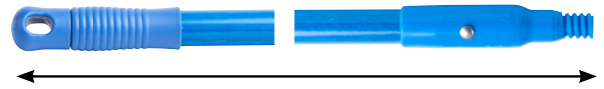

54" to 60" / De 54 à 60 po

M2 Code Code M2	Description	Pack Wt LB (S) Poids (lb) (S)	Pack Wt KG Poids (kg)	Cubic Ft Pi3	Pack Contenu	List Price Liste des prix
FH-F354-BL	54" / 137 cm Fiberglass Handle – Blue / Manche de fibre de verre, 54" / 137 cm, bleu	14.5	6.7		12/1	\$ 19.02
FH-F360-WH	60" / 152 cm Fiberglass Handle – White / Manche de fibre de verre, 60" / 152 cm, blanc	16.5	7.5		12/1	\$ 19.02
FH-F360-GN	60" / 152 cm Fiberglass Handle – Green / Manche de fibre de verre, 60" / 152 cm, vert	16.5	7,5		12/1	\$ 19.02
FH-F360-BL	60" / 152 cm Fiberglass Handle – Blue / Manche de fibre de verre, 60" / 152 cm, bleu	16.5	7.5		12/1	\$ 19.02
FH-F360-RD	60" / 152 cm Fiberglass Handle – Red / Manche de fibre de verre, 60" / 152 cm, rouge	16.5	7,5		12/1	\$ 19.02
FH-F360-YE	60" / 152 cm Fiberglass Handle – Yellow / Manche de fibre de verre, 60" / 152 cm, jaune	16.5	7.5		12/1	\$ 19.02

HYGIENIC MONOBLADE SQUEEGEES

Where hygiene is of utmost importance to the food industry, professional kitchen, hospital, labs and pharmaceutical industry



RACLETTE HYGIÉNIQUE MONO-LAME

Où l'hygiène est d'une importance primordiale: l'industrie alimentaire, les cuisines professionnelles, les hôpitaux, les laboratoires et l'industrie pharmaceutique.

- Optimal socket handle design
 - Protected soft touch edges
 - Ideal for smooth surfaces
 - Autoclavable 138° C / 280° F
 - One piece squeegee: no hidden bacteria
 - High tear and wear resistance
 - Use for floor and walls
- Conception optimale de la poignée
 - Bords Tactiles protégés
 - Idéal pour les surfaces lisses
 - Stérilisation à la vapeur 138C/280F
 - Raclette d'une seule pièce: pas de bactérie cachée
 - Haute résistance aux déchirures et à l'usure
 - Utilisez pour les planchers et les murs



Colour code handles also available
Manches de couleur aussi disponibles

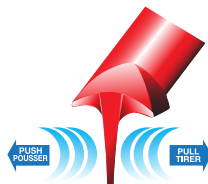

Smooth Water Flow /
Écoulement doux de l'eau

M2 Code Code M2	Description	Pack Wt LB (S) Poids (lb) (S)	Pack Wt KG Poids (kg)	Cubic Ft Pi3	Pack Contenu	List Price Liste des prix
FS-MB220-WH	20"/50 cm MonoBlade Floor Squeegee with Scraper - White / 20"/50 cm Raclette à plancher mono-lame avec racloir - blanc				6/1	\$ 85.89
FS-MB224-WH	24"/60 cm MonoBlade Floor Squeegee with Scraper - White / 24"/60 cm Raclette à plancher mono-lame avec racloir - blanc				6/1	\$ 113.52
FS-MB224-GN	24"/60 cm MonoBlade Floor Squeegee with Scraper - Green / 24"/60 cm Raclette à plancher mono-lame avec racloir - vert				6/1	\$ 113.52
FS-MB224-BL	24"/60 cm MonoBlade Floor Squeegee with Scraper - Blue / 24"/60 cm Raclette à plancher mono-lame avec racloir - bleu				6/1	\$ 113.52
FS-MB224-RD	24"/60 cm MonoBlade Floor Squeegee with Scraper - Red / 24"/60 cm Raclette à plancher mono-lame avec racloir - rouge				6/1	\$ 113.52
FS-MB224-YE	24"/60 cm MonoBlade Floor Squeegee with Scraper - Yellow / 24"/60 cm Raclette à plancher mono-lame avec racloir - jaune				6/1	\$ 113.52

BABY HIGH CHAIR & CHANGE TABLE

CHAISE HAUTE POUR BÉBÉ



M2 Code Code M2	Description	Pack Wt LB (S) Poids (lb) (S)	Pack Wt KG Poids (kg)	Cubic Ft Pi3	Pack Contenu	List Price Liste des prix
HC-2900	Baby High Chair - Grey / Chaise haute pour bébé - Gris	12	5.5		1	\$ 303.64
BCT-7818	Baby changing table with liner dispenser - Wall mount / Table à langer avec distributrice de lingettes - montage mural				1	\$ 706.12



M2 Code Code M2	Description	Pack Wt LB (S) Poids (lb) (S)	Pack Wt KG Poids (kg)	Cubic Ft Pi3	Pack Contenu	List Price Liste des prix
BRP-210WS-WH	9" / 23 cm Short Handle Pot Brush - White Fiber / Pinceau à manche court 9 po / 23 cm - fibre blanc	5	2	.5	12	\$ 11.73
BRP-210WS-GN	9" / 23 cm Short Handle Pot Brush - Green Fiber / Pinceau à manche court 9 po / 23 cm - fibre vert	5	2	.5	12	\$ 11.73
BRP-210WS-BL	9" / 23 cm Short Handle Pot Brush - Blue Fiber / Pinceau à manche court 9 po / 23 cm - fibre bleue	5	2	.5	12	\$ 11.73
BRP-210WS-RD	9" / 23 cm Short Handle Pot Brush Red Fiber / Pinceau à manche court 9 po / 23 cm - fibre rouge	5	2	.5	12	\$ 11.73
BRP-210WS-YE	9" / 23 cm Short Handle Pot Brush - Yellow Fiber / Pinceau à manche court 9 po / 23 cm - fibre jaune	5	2	.5	12	\$ 11.73



M2 Code Code M2	Description	Pack Wt LB (S) Poids (lb) (S)	Pack Wt KG Poids (kg)	Cubic Ft Pi3	Pack Contenu	List Price Liste des prix
BRP-210WL-WH	20" / 50 cm Long Handle Pot Brush - White Fiber / Brosse à pot de 20 po / 50 cm à manche long - fibre blanc	9	4	1.2	6	\$ 16.19
BRP-210WL-GN	20" Long Handle Pot Brush - Green Fiber / Brosse à pot de 20 po / 50 cm à manche long - fibre vert	9	4	1.2	6	\$ 16.19
BRP-210WL-BL	20" Long Handle Pot Brush - Blue Fiber / Brosse à pot de 20 po / 50 cm à manche long - fibre bleue	9	4	1.2	6	\$ 16.19
BRP-210WL-RD	20" Long Handle Pot Brush - Red Fiber / Brosse à pot de 20 po / 50 cm à manche long - fibre rouge	9	4	1.2	6	\$ 16.19
BRP-210WL-YE	20" Long Handle Pot Brush - Yellow Fiber / Brosse à pot de 20 po / 50 cm à manche long - fibre jaune	9	4	1.2	6	\$ 16.19







FOOD PROCESSING - PUSHBROOMS

HYGIENE FLOOR BROOM 18"/45 CM / BALAI À PLANCHER HYGIÉNIQUE 18"/45 CM

Push broom for cleaning floors and walls in the food industry and all those professional areas where hygiene is a priority. PBT fiber Medium.
Brosse à plancher idéale pour les planchers de ciment et les murs dans l'industrie alimentaire et de tous les secteurs professionnels où l'hygiène est une priorité. Fibers PBT à gros poils courts.



Please specify colour when ordering
S.v.p. spécifier la couleur au moment de la commande

-  WH = B
-  GN = V
-  BL = BL
-  RD = R
-  YE = J

HYGIENE FLOOR BROOM 24"/60 CM / BALAI À PLANCHER HYGIÉNIQUE 24"/60 CM

Floor brush ideal for cleaning floors and walls in the food industry and all those professional areas where hygiene is a priority. PBT fiber Medium.
Brosse à plancher idéale pour les planchers de ciment et les murs dans l'industrie alimentaire et de tous les secteurs professionnels où l'hygiène est une priorité. Fibres PBT moyennes



130 °C
270 °F



M2 Code Code M2	Description	Pack Wt LB (S) Poids (lb) (S)	Pack Wt KG Poids (kg)	Cubic Ft Pi3	Pack Contenu	List Price Liste des prix
FP-FB18M	Hygiene Floor Broom 18"/45 cm - Bristles Length 3.15"/80 mm / Balai à plancher hygiénique 18"/45 cm - Longueur 3.15"/80 mm				3/1	\$ 100.89
FP-FB24M	Hygiene Floor Broom 24"/60 cm - Bristles Length 3.15"/80 mm / Balai à plancher hygiénique 24"/60 cm - Longueur - 3.15"/80 mm				3/1	\$ 142.45

FLOOR SCRUBBING BRUSH 12"/30 CM / BALAI-BROSSE À PLANCHER 12"/30 CM

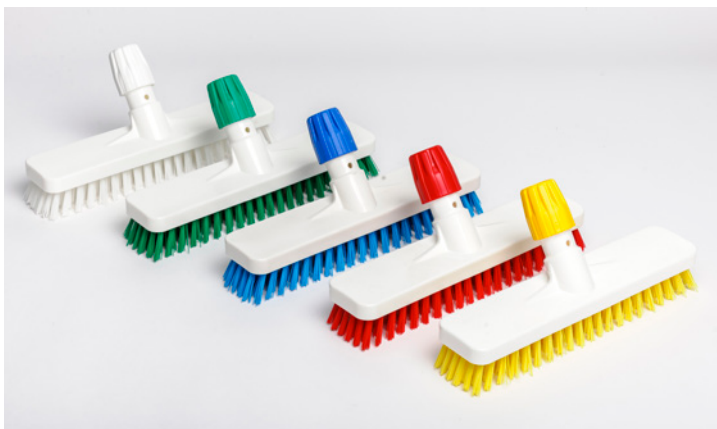

Floor brush ideal for scrubbing floors and walls in the food industry and all those professional areas where hygiene is a priority. PBT fiber Coarse Short Bristles.

Balai-poussoir pour les planchers de ciment et les murs dans l'industrie alimentaire et de tous les secteurs professionnels où l'hygiène est une priorité. Fibres PBT moyennes.

M2 Code Code M2	Description	Pack Wt LB (S) Poids (lb) (S)	Pack Wt KG Poids (kg)	Cubic Ft Pi3	Pack Contenu	List Price Liste des prix
FP-FS12C	Floor Scrubbing Brush 12"/30 cm - Bristles Length - 1.10"/28 mm / Balai-brosse à plancher 12"/30 cm Longueur 1.10"/28 mm				4/1	\$ 51.03

**UPRIGHT ANGLE BROOM 12"/30 CM /
BALAI À PLANCHER HYGIÉNIQUE – 12"/30 CM**

Upright Angle brushes are ideal for sweeping floors in the food industry and all those professional areas where hygiene is a priority. PBT fiber MEDIUM.
Balai droit en angle idéal pour nettoyer les planchers de ciment et les murs dans l'industrie alimentaire et tous les domaines professionnels où l'hygiène est une priorité. Fibres PBT moyennes.

**UPRIGHT BROOM SHORT FIBERS – 13"/33 CM /
BALAI EN ANGLE MONTANT 13"/33 CM**

Upright Brooms are ideal for cleaning floors in the food industry and all those professional areas where hygiene is a priority. PBT fiber MEDIUM.
Balai droit idéal pour le nettoyage des planchers de ciment et les murs dans l'industrie alimentaire et tous les domaines professionnels où l'hygiène est une priorité. Fibres PBT moyennes.



**SPECIFY COLOUR
WHEN ORDERING
SPÉCIFIER LA COULEUR LORS
DE LA COMMANDE**



M2 Code Code M2	Description	Pack Wt LB (S) Poids (lb) (S)	Pack Wt KG Poids (kg)	Cubic Ft Pi3	Pack Contenu	List Price Liste des prix
FP-AB12C	Upright Angle Broom 12" / 30 cm - Bristles Length – 4.53" / 115 mm / Balai en angle montant 12" / 30 cm Longueur – 4.53" / 115 mm				8/1	\$ 45.45
FP-UB13C	Upright Broom Short Fibers 13" / 33 cm - Bristles Length 2.95" / 75mm / Balai en angle montant fibres courtes 13" / 33 cm – Longueur 2.95" / 75mm				10/1	\$ 39.04

HANDLES / MANCHE

**ALUMINUM HANDLE 54" / 137 CM /
MANCHE ALUMINIUM 54"/137 CM/**

Aluminium handle with cap and European IT thread to fit all our items. Length 54"/137cm. diameter 1" / 23.5 mm, thickness 0,90 mm. Cap with loop available in 5 colour coded according to HACCP regulations.
Manche en aluminium avec crochet, fileté IT européen pour s'adapter à tous nos articles. Longueur 54 po/137cm, diamètre 1 po / 23.5 mm épaisseur 0.90 mm. Crochet avec boucle disponible dans 5 codes de couleur conformément à la réglementation HACCP.

**MONOBLOCK PLASTIC SHORT HANDLE – 24" / 60 CM /
MANCHE COURT EN PLASTIQUE MONOBLOC 24"/60CM**

**MONOBLOCK PLASTIC LONG HANDLE - 57" / 145 CM
MANCHE EN PLASTIQUE LONG MONOBLOC 57"/ 145 CM**

Handle made of plastic strengthened with Fiberglass, length 24"/60 cm., diameter from 22 to 32 mm., with European IT thread.
Manche en plastique renforcé avec fibre de verre, longueur 24 po /60 cm., diamètre de 22 à 32 mm., avec filetage IT européen.



**SPECIFY COLOUR
WHEN ORDERING
SPÉCIFIER LA COULEUR LORS
DE LA COMMANDE**



M2 Code Code M2	Description	Pack Wt LB (S) Poids (lb) (S)	Pack Wt KG Poids (kg)	Cubic Ft Pi3	Pack Contenu	List Price Liste des prix
FP-AH54	Aluminum Handle 54" / 137 cm / 1" / 25 mm Dia / Manche Aluminum 54"/137 cm / 1" / 25 mm Diam.				10/1	\$ 29.52
FP-MB24	MonoBlock Plastic Short Handle 24" / 60 cm / Dia 1" / 25mm/ Manche court en plastique monobloc 24"/ 60cm / Dim 1" / 25 mm				10/1	\$ 26.24
FP-MB57	MonoBlock Plastic Long Handle 57" / 145 cm / Dia 1" / 25 mm/ Manche en plastique long monobloc 57"/ 145 cm / Dim 1" / 25 mm				10/1	\$ 41.57



BRUSHES / BROSSE

CYLINDER BRUSH 2.6" / 65 MM / BROSSE À CYLINDRE 2.6" / 65 MM

Ideal for cleaning pipes and tubes, meat mincers and for the fish-food industry. European IT thread allows fastening of a handle. PBT fiber available MEDIUM.

Idéal pour le nettoyage des tuyaux et des tubes, des hachoirs à viande et pour l'industrie alimentaire des poissons. Filetage IT européen, permet la fixation d'une poignée. Fibres PBT moyennes

Please specify colour when ordering
S.v.p. spécifier la couleur au moment de la commande



WH = B GN = V BL = BL RD = R YE = J



FP-CB2M



SPECIFY COLOUR
WHEN ORDERING
SPÉCIFIER LA COULEUR LORS
DE LA COMMANDE

CYLINDER BRUSH 3.5" / 90 MM / BROSSE À CYLINDRE 3.5" / 90 MM

Ideal for cleaning pipes and tubes, meat mincers and for the fish-food industry. European IT thread allows fastening of a handle. PBT fiber available MEDIUM

CYLINDER BRUSH 4.7" / 120 MM / BROSSE À CYLINDRE 4.7" / 120 MM

Idéal pour le nettoyage des tuyaux et des tubes, des hachoirs à viande et pour l'industrie alimentaire des poissons. Filetage IT européen, permet la fixation d'une poignée. Fibres PBT moyennes



FP-CB3M



FP-CB4M

M2 Code Code M2	Description	Pack Wt LB (S) Poids (lb) (S)	Pack Wt KG Poids (kg)	Cubic Ft Pi3	Pack Contenu	List Price Liste des prix
FP-CB2M	Cylinder Brush 2.6" / 65 mm / Dia - Bristles Length 0.79" / 20 mm / Brosse à cylindre 2.6" / 65 mm / Diam Longueur 0.79" / 20 mm				6/1	\$ 22.48
FP-CB3M	Cylinder Brush 3.5" / 90 mm / Dia - Bristles Length 1.26" / 32 mm / Brosse à cylindre 3.5" / 90 mm / Diam Longueur 1.26" / 32 mm				4/1	\$ 25.48
FP-CB4M	Cylinder Brush 4.7" / 120 mm Dia.- Bristles Length 1.81" / 46 mm / Brosse à cylindre 4.7" / 120 mm / Dia Longueur 1.81" / 46 mm				6/1	\$ 26.90

**BANNISTER BRUSH LONG HANDLE – 15"/39 CM /
BROSSE POUR RAMPE À MANCHE LONG 15"/39 CM**

Suitable for cleaning workbenches, chopping boards, grating machines, machine parts, or other equipment for the food industry. PBT fiber Soft.

Convient pour le nettoyage des établis, planche à découper, machines à râper, pièces de machines, ou d'autres équipements pour l'industrie alimentaire. Fibres PBT douces.



**SCRUBBING BRUSH LONG HANDLE – 17"/44 CM /
BROSSE À RÉCURER MANCHE LONG – 17"/44 CM**

This long handle brush allows a safe approach to machine cleaning, reaching into deep containers and buckets, pipes and difficult recesses and corners. PBT fiber Medium.

Cette brosse à long manche permet une approche sûre pour le nettoyage d'une machine, pour atteindre les récipients profonds et les seaux, tuyaux et recoins et les coins difficiles. Fibres PBT moyennes.



M2 Code Code M2	Description	Pack Wt LB (S) Poids (lb) (S)	Pack Wt KG Poids (kg)	Cubic Ft Pi3	Pack Contenu	List Price Liste des prix
FP-BB15S	Bannister Brush Long Handle 15"/39 cm - Bristle Length 2.17"/55 mm Brosse pour rampe à manche long 15"/39 cm Longueur – 2.17"/55 mm				12/1	\$ 31.55
FP-SB17M	Scrubbing Brush Long handle 17"/44 cm- Bristles Length 1.77"/45 mm / Brosse à récurer manche long 17"/44 cm - Longueur 1.77"/45mm				12/1	\$ 37.05

**TANK BRUSH - 9"/22 CM /
BROSSE DE RÉSERVOIR 9"/22 CM**

Ideal for cleaning tanks, cisterns, round containers. PBT fiber MEDIUM .

Idéal pour le nettoyage des réservoirs, citernes, contenants ronds. Fibres PBT moyennes disponibles.

**SPECIFY COLOUR
WHEN ORDERING
SPÉCIFIER LA COULEUR LORS
DE LA COMMANDE**



**POT/DETAIL BRUSH SHORT HANDLE – 10"/26 CM /
BROSSE À RÉCURER MANCHE COURT – 10"/26 CM**

Multi-purpose cleaning brush, suitable for cooking areas, food industry machinery and equipment, workbenches. PBT fiber Medium.

Brosse de nettoyage multi-usages, adapté aux domaines de cuisson, les machines de l'industrie alimentaire et de l'équipement, des établis. Fibres PBT moyennes.



FOOD PROCESSING BRUSHES THAT COME FROM EUROPE ALL HAVE THE EURO THREAD

This adapter will allow you to convert the brush to a locking collar

LES BROSSES DE CUISINE QUI PROVIENNENT D'EUROPE ONT TOUTES DES FILETS EUROPEENS.

Cet adaptateur vous permettra de convertir ces filets en un collier verrouillable.

M2 Code Code M2	Description	Pack Wt LB (S) Poids (lb) (S)	Pack Wt KG Poids (kg)	Cubic Ft Pi3	Pack Contenu	List Price Liste des prix
FP-PB10M	Pot/Detail Brush Short Handle 10"/26 cm - Bristles Length 1.57"/40 mm / Brosse à récurer manhe court 10"/26 cm Longueur 1.57"/40 mm				4	\$ 41.50
FP-TB9C	Tank Brush 9"/22 cm - Bristles Length 1.57"/40 mm / Brosse de réservoir 9"/22 cm - bleu Longueur 1.57"/40 mm				6	\$ 85.21
FH-A40	Euro Adapter to a Cone Locking Collar / Adaptateur Euro/bague de blocage				1	\$ 14.27



BRUSHES / BROSSE

NAIL BRUSH 4.5"/ 11.5 CM / BROSSE À ONGLES 4.5"/ 11.5 CM

Nail and hand brush with hanging loop. Also for cleaning small containers and machine parts. PBT fiber MEDIUM.

Brosse à main et ongles avec boucle de suspension. Également pour le nettoyage de petits récipients et pièces de machines. Fibres PBT douces et moyennes disponibles.

HAND SCRUB BRUSH 9"/ 23 CM / BROSSE À MAIN 9"/ 23 CM

Suitable for multi-purpose use in the food industry, for tanks, containers, workbenches, chopping boards, machine parts. PBT fiber, MEDIUM.

Convient pour une utilisation polyvalente dans l'industrie alimentaire, pour les citernes, conteneurs, établis, planches à découper, des pièces de machines. Fibres PBT moyennes et dures disponibles.



M2 Code Code M2	Description	Pack Wt LB (S) Poids (lb) (S)	Pack Wt KG Poids (kg)	Cubic Ft Pi3	Pack Contenu	List Price Liste des prix
FP-NB4M	Nail Brush 4.5"/ 11.5 cm - Bristles Length 0.91"/23 mm / Brosse à ongles 4.5"/ 11.5 cm Longueur 0.91"/23 mm				12/1	\$ 17.29
FP-HS9M	Hand Scrub Brush 9"/ 23 cm - Bristles Length 1.06"/27 mm / Brosse à main 9"/ 23 cm Longueur 1.06"/ 27mm				6/1	\$ 27.35



Please specify colour when ordering
S.v.p. spécifier la couleur au
moment de la commande



WH = B GN = V BL = BL RD = R YE = J

3"/ 7.5 CM - STAINLESS STEEL SCRAPER

Multipurpose spatula 3" polypropylene handle and blade flexible. Made of stainless steel, 0.9 mm thick, suitable for removing particles stuck on hard surfaces.

3"/ 7.5 CM - GRATTOIR EN ACIER INOXYDABLE

Spatule à usage multiple de 3" avec poignée en polypropylène et lame flexible en acier inoxydable de 0,9 mm d'épaisseur, appropriées pour éliminer les particules collées sur des surfaces dures.

M2 Code Code M2	Description	Pack Wt LB (S) Poids (lb) (S)	Pack Wt KG Poids (kg)	Cubic Ft Pi3	Pack Contenu	List Price Liste des prix
FP-SCR9203	3"/ 7.5 cm -Stainless Steel Spatula - Thickness - 0.9 mm 3"/ .5 cm Spatule en acier inoxydable - épaisseur 0.9 mm				12/1	\$ 19.55



5"/ 12.7 CM ROUND ERGONOMIC HAND SCRUB

Ergonomic Round Brush for cleaning small areas. Ideal for cleaning food containers. The design of this brush allows the user to push harder during use, achieving a more effective cleaning.

5"/ 12.7 CM BROSSE À MAIN RONDE ERGONOMIQUE

Brosse ronde ergonomique pour nettoyer les petites zones. Idéal pour le nettoyage des récipients de transport alimentaires.

La conception de cette brosse permet à l'utilisateur de pousser plus fort lors de l'utilisation pour réaliser un nettoyage plus efficace.

M2 Code Code M2	Description	Pack Wt LB (S) Poids (lb) (S)	Pack Wt KG Poids (kg)	Cubic Ft Pi3	Pack Contenu	List Price Liste des prix
FP-HS4332-BL	5"/ 12.7 cm Round Ergonomic Hand Scrub - Blue only - 1 3/4" x 44 mm / 5"/ 12.7 cm Brosse à main ronde ergonomique - bleu seulement - 1 3/4" x 44 mm				6/1	\$ 18.79

TWISTED WIRE BRUSHES / BROSE DE FIL TORSADÉ

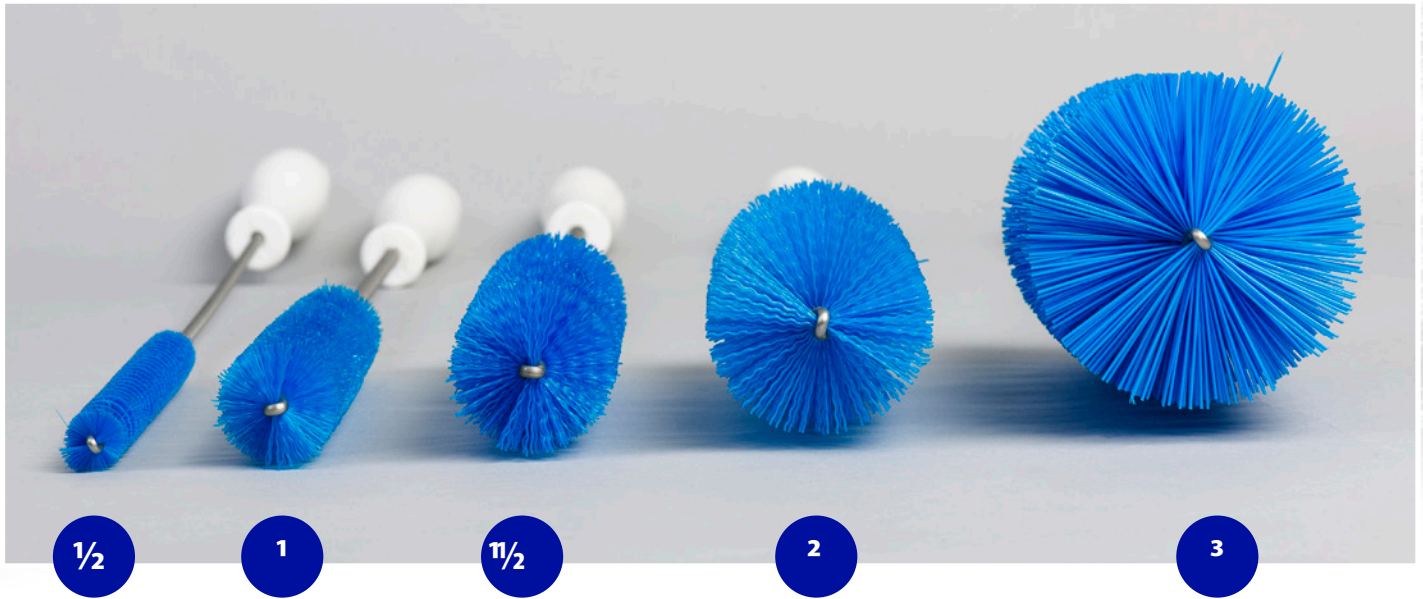

TWISTED WIRE BRUSHES AND ACCESSORIES BROSSES DE FIL TORSADÉ ET ACCESSOIRES

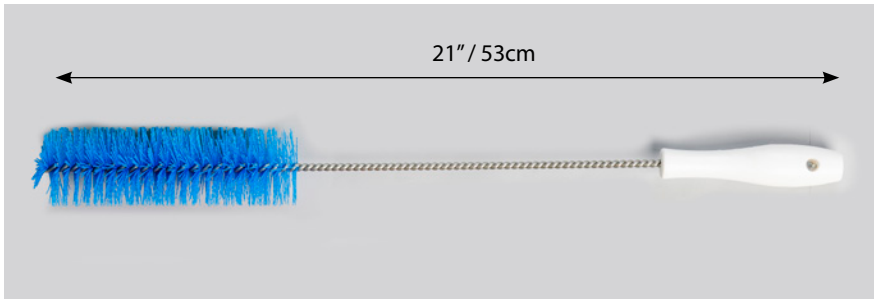

Please specify colour when ordering
S.v.p. spécifier la couleur au moment de la commande



WH = B GN = V BL = BL RD = R YE = J

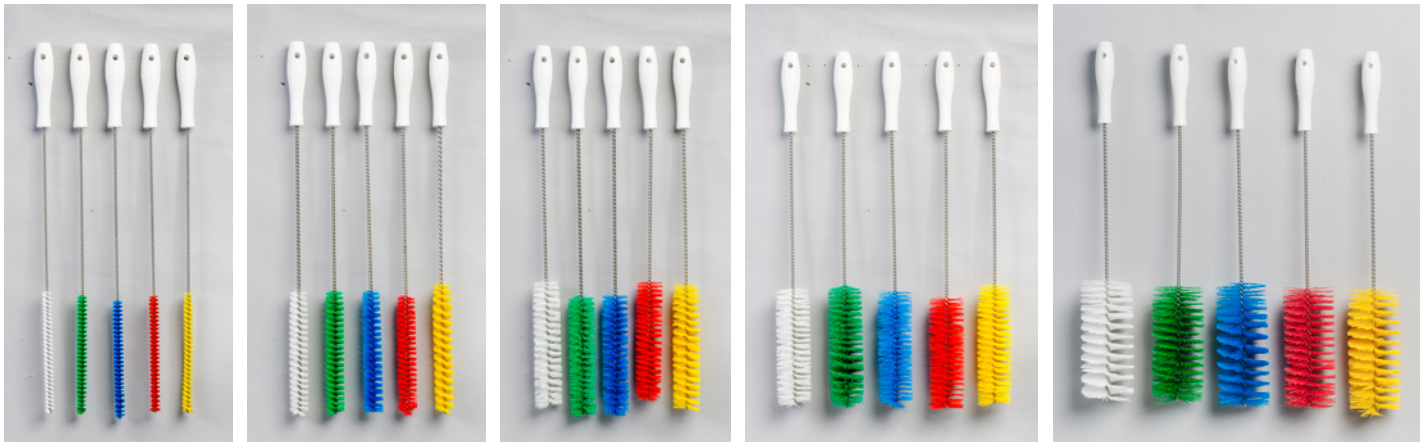

M2 Code Code M2	Description	Pack Wt LB (S) Poids (lb) (S)	Pack Wt KG Poids (kg)	Cubic Ft Pi3	Pack Contenu	List Price Liste des prix
FP-TW5105	1/2" / 1.25 cm Twisted in Wire Brush / 1/2" / 1.25 cm Brosse de fil torsadé				6/1	\$ 14.42
FP-TW5110	1" / 2.25 cm Twisted in Wire Brush / 1" / 2.25 cm Brosse de fil torsadé				6/1	\$ 18.38
FP-TW5115	1 1/2" / 3.8 cm Twisted in Wire Brush / 1 1/2" / 3.8 cm Brosse de fil torsadé				6/1	\$ 18.77
FP-TW5120	2" / 5 cm Twisted in Wire Brush / 2" / 5 cm Brosse de fil torsadé				6/1	\$ 18.87
FP-TW5130	3" / 7.6 cm Twisted in Wire Brush / 3" / 7.6 cm Brosse de fil torsadé				6/1	\$ 21.19



SPECIALTY FOOD SERVICE BRUSHES / BROSSES DE SPÉCIALITÉ POUR SERVICES ALIMENTAIRES



1



2 1/2

SOLUTION LINE BRUSH / BROSE DE LIGNE SOLUTION







CAN BE SCREWED TOGETHER TO INCREASE LENGTH
PEUVENT ÊTRE VISSÉ ENSEMBLE POUR AUGMENTER LA LONGUEUR

32.6" / 83 CM

Please specify colour when ordering
S.v.p. spécifier la couleur au moment de la commande

●
●
●
●
●

WH = B GN = V BL = BL RD = R YE = J

M2 Code Code M2	Description	Pack Wt LB (S) Poids (lb) (S)	Pack Wt KG Poids (kg)	Cubic Ft Pi3	Pack Contenu	List Price Liste des prix
1" / 2.25CM TWISTED WIRE BRUSH FOR SNAKE / 1" / 2.25 CM BROSE DE FIL TORSADÉ POUR SERPENT						
FP-TW5210	1" / 2.25 cm Twisted in Wire Brush for Snake -SS / 1" X 2.25 cm Brosse de fil torsadé pour serpent - SS				6/1	\$ 26.51
2 1/2" / 6.3CM TWISTED WIRE BRUSH FOR SNAKE / 2 1/2" / 6.3 CM BROSE EN FIL TORSADÉ POUR SERPENT						
FP-TW5225	2.5" / 6.3 cm Twisted in Wire Brush for Snake -SS / 2.5" / 6.3 cm Brosse en fil torsadé pour serpent - SS				6/1	\$ 29.32
STAINLESS STEEL SNAKE FOR TWISTED WIRE BRUSH / SERPENT POUR BROSE EN FIL TORSADÉ ACIER INOXYDABLE						
FP-TW5280SS	Twisted Wire Snake Extension for Brush - 32.6" / 83 cm / extension de serpent pour brosse torsadé - 32.6" / 83 cm				6/1	\$ 46.03
HANDLE FOR TWISTED WIRE BRUSH / POIGNÉE POUR BROSE EN FIL TORSADÉ						
FP-TW5290	Handle for Twisted Wire Snake / Poignée de serpent pour brosse en fil torsadé				6/1	\$ 12.82

4" DRAIN BRUSH (WITHOUT HANDLE)

Brushes for cleaning drains in food processing facilities. Base made of solid polypropylene. Fibers made of PBT and takes a threaded handle.

4" BROSE À DRAIN (SANS POIGNÉE)

Brosse pour le nettoyage des drains dans les installations de transformation des aliments, à base de fibres de polypropylène solide PBT et noires, ces brosses acceptent une poignée fileté.

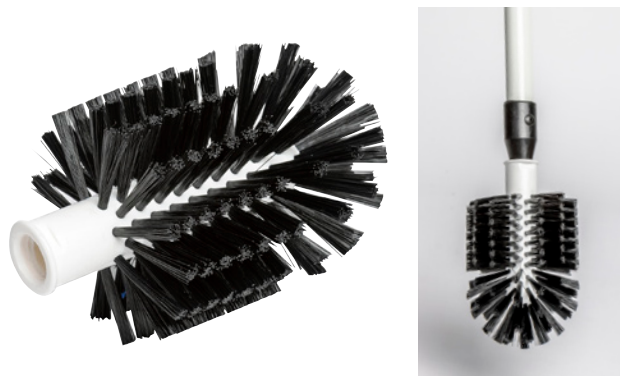

4" TUBE AND DRAIN BRUSH

Tube & drain brushes for meat grinders (also useful in cleaning valves and pipes), manufactured for food contact areas to ensure proper sanitation.

4" BROSE À TUYAU ET DRAIN

Les brosses à tuyau et drain pour hachoirs à viande (aussi utiles pour nettoyer les vannes et tuyaux), fabriqués pour les zones de contact avec les aliments pour assurer la santé.



M2 Code Code M2	Description	Pack Wt LB (S) Poids (lb) (S)	Pack Wt KG Poids (kg)	Cubic Ft Pi3	Pack Contenu	List Price Liste des prix
FP-DB5302-BK	4" / 10 cm Drain Brush (Without Handle) / 4" / 10 cm Brosse à drain (sans poignée)				3/1	\$ 20.71
FP-DB5302-BL	4" / 10 cm Tube and Drain Brush - Blue / 4" / 10 cm Brosse à tuyau et drain - bleu				4/1	\$ 20.71
FH-F360-WH	60" / 152 cm Fiberglass Handle - White / Manche de fibre de verre, 60" / 152 cm, blanc	16.5	7.5	.5	12/1	\$ 30.96

GLAZING BRUSHE / BROSSE À LUSTRER

2" / 5 CM GLAZING BRUSH

Glazing brushes with soft PBT 2" fiber in length and caliber of 0.006", widely used in the bakery industry and general food processing areas.

2" / 5 CM BROSSE À LUSTRER

Brosses à glacer avec fibres PBT de 2" de longueur et calibre 0,006", largement utilisées dans l'industrie de la boulangerie et dans les domaines de la restauration rapide.

Please specify colour when ordering
S.v.p. spécifier la couleur au moment de la commande



WH = B GN = V BL = BL RD = R YE = J



2" / 5 CM GLAZING BRUSH WITH HOOK

Glazing brushes with soft PBT 2" fiber in length and caliber of 0.006", widely used in the bakery industry and general fast food processing areas.

These brushes have a hook to hang on the edges of pots and Food containers helps to prevent leakage.

2" / 5 CM BROSSE À LUSTRER AVEC CROCHET

Brosse à lustrer avec une fibre douce PBT de 2" de longueur et de calibre 0,006", largement utilisé dans l'industrie de boulangerie et en général dans les domaines de la transformation des aliments.

Cette brosse a un crochet pour suspendre sur les bords des chaudrons et récipients alimentaires, aide à prévenir les fuites.

M2 Code Code M2	Description	Pack Wt LB (S) Poids (lb) (S)	Pack Wt KG Poids (kg)	Cubic Ft Pi3	Pack Contenu	List Price Liste des prix
FP-GL5002	2" / 5 cm Glazing Brush / 2" / 5 cm Brosse à lustrer				12/1	\$ 18.97
FP-GL5002HK-WH	2" / 5 cm Glazing Brush with Hook / 2" / 5 cm Brosse à lustrer avec crochet				12/1	\$ 12.74

GRILL BRUSHES / BROSSES GRILLÉES LONG & SHORT HANDLE / POIGNÉE LONGUE ET COURTE



M2 Code Code M2	Description	Pack Wt LB (S) Poids (lb) (S)	Pack Wt KG Poids (kg)	Cubic Ft Pi3	Pack Contenu	List Price Liste des prix
BBQ-1200	12"/30 cm BBQ Brush CC - Brass Bristles with Heavy Duty Scraper / 12"/30 cm Brosse à BBQ avec Poils en laiton inoxydable et grattoir robuste	9	4.08	.54	24	\$ 4.46
BBQ-1202	18"/45 cm Long Handle Ergo BBQ Brush with SS Bristles and Heavy Duty Scraper / 18"/45 po Brosse à BBQ manche long ergonomique de 18 pouces avec poils en acier inoxydable et grattoir robuste	7	3.18	1.3	12	\$ 9.52
BBQ-1203	Extra Large 2 Sided BBQ Brush with SS Bristles & Heavy Duty Scrub Pad and Scraper Brosses à BBQ à 2 côtés très grande - Poil en acier inoxydable et tampon récurant robuste	7.2	3.27	1.5	12	\$ 14.87

NATURAL GRILL BRUSHES / BROSSES NATURELLES DE GRIL



M2 Code Code M2	Description	Pack Wt LB (S) Poids (lb) (S)	Pack Wt KG Poids (kg)	Cubic Ft Pi3	Pack Contenu	List Price Liste des prix
BBQ-W2200	20" / 50 cm Large Handle BBQ Brush w Scraper - Wood Block Bassine Fiber / Grande brosse de BBQ avec grattoir de 20 po et bloc en bois et fibre bassine				12	\$ 30.87
BBQ-W2201	20" / 50 cm Long Handle Wood Pot Brush w Natural Scraper-Bassine Fibre / Brosse en bois à manche long de 20 po avec grattoir en fibre naturelle bassine				12	\$ 34.24
BBQ-W2202	9 x 4" / 23 x 10 cm Wood Scrubbing Brush -Bassine Fiber / Brosse à récurer en bois 9"x 4"- fibre bassine				12	\$ 34.24



SCOOPS / ÉCOPEES

MINI HAND SCOOP 500 G / ML PELLE À MAIN MINI 500 G / ML

- Polypropylene hand scoop, from 500 g/mL capacity.
- Collect a variety of feed, flours, cereals and liquids

SMALL HAND SCOOP 1000 G / ML PELLE À MAIN PETITE 1000 G / ML

- Pelle à main en polypropylène, à partir de 500 g / ml de capacité
- Recueille une variété d'aliments pour animaux, des farines, des céréales et des liquides.



-30 ° C / -22 ° F
+ 80 ° C / 176 ° F



M2 Code Code M2	Description	Pack Wt LB (S) Poids (lb) (S)	Pack Wt KG Poids (kg)	Cubic Ft Pi3	Pack Contenu	List Price Liste des prix
FP-SC500-WH	Mini Hand Scoop - 500 g/mL capacity / Pelle à main mini - capacité 500 g/mL				1	\$ 9.19
FP-SC1000-WH	Small Hand Scoop 1000 g/mL capacity/ Pelle à main petite - capacité 1000 g/mL				1	\$ 13.99
FP-SC1500-WH	Medium Hand Scoop 1500 g/mL capacity/ Pelle à main médium - capacité 1500 g/mL				1	\$ 34.71

LARGE HAND SCOOP 2000 G / ML PELLE À MAIN LARGE 2000 G / ML

- Polypropylene hand scoop, 2000 g/mL capacity.
- Collect a variety of feed, flours, cereals and liquids
- Pelle à main en polypropylène, capacité 2000g/mL
- Recueille une variété d'aliments pour animaux, des farines, des céréales et des liquides.

ROUND BOWL SCOOP 2000 G / ML PELLE EN BOL ROND 2000 G / ML

- POLYPROPYLENE Round Bowl Scoop 2000 g/mL capacity.
- Bol-cuillère rond en polypropylène, capacité 2000 g/mL



-30 ° C / -22 ° F
+ 80 ° C / 176 ° F



M2 Code Code M2	Description	Pack Wt LB (S) Poids (lb) (S)	Pack Wt KG Poids (kg)	Cubic Ft Pi3	Pack Contenu	List Price Liste des prix
FP-SC2000-WH	Large Hand Scoop 2000 g/mL Capacity / Pelle à main large - capacité 2000 g/mL				1	\$ 45.21
FP-SC2L-WH	Round Bowl Scoop 2000 g/mL Capacity/ Pelle en bol rond - capacité 2000 g/mL				1	\$ 45.77

SCRAPERS / GRATTOIRS

Our scrapers are designed for purpose and ease of use, without compromising strength and durability. The non-stick one piece scraper head is manufactured with both a square and round edged blade making it highly effective on a wide range of surfaces.

With no cracks or crevices, screws or rivets these tough and durable scrapers are virtually unbreakable and will not corrode or rust. Available in various colours to suit all colour coded requirements, the scrapers are an ideal product for hygiene applications.

Nos grattoirs sont conçus de façon à faciliter l'utilisation, sans compromettre la solidité ou la durabilité. La tête non collante du grattoir d'une seule pièce est fabriquée à la fois avec un carré et une lame ronde tranchante qui le rend très efficace sur une large gamme de surfaces.

En l'absence de fissures ou crevasses, de vis ou de rivets, ces grattoirs robustes et durables sont pratiquement incassables et ne seront pas corrodés ou rouillés. Disponibles en différentes couleurs pour s'adapter à toutes les exigences du code couleur, ces grattoirs sont un produit idéal pour les applications de l'hygiène.

SMALL HAND SCRAPER 3"/7.5 CM / GRATTOIR À MAIN PETIT 3"/7.5 CM

An invaluable product for removing various substances from flat surfaces such as work surfaces, table tops and conveyor belts. Polypropylene small scraper.

LARGE HAND SCRAPER 4"/10 CM / GRATTOIR À MAIN LARGE 4"/10 CM

Un produit précieux pour éliminer diverses substances sur des surfaces planes telles que les surfaces de travail, dessus de table et des courroies des convoyeurs. Petit grattoir en polypropylène, largeur

SMALL FLEXI-SCRAPER 6"/15 CM / GRATTOIR FLEXIBLE PETIT 6"/15 CM

Suitable for a variety of applications. Polypropylene small flexi scraper, 15 cm wide. Adapté pour diverses applications. Petit grattoir flexible en polypropylène, largeur 15 cm

LARGE FLEXI-SCRAPER 9"/23 CM / GRATTOIR FLEXIBLE GRAND 9"/23 CM

Suitable for a variety of applications. Polypropylene large flexi scraper, 23 cm wide. Adapté pour diverses applications. Large grattoir en polypropylène, largeur 23 cm

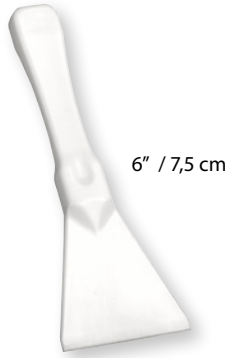

6" / 7,5 cm



4" / 10 cm



-30 ° C / -22 ° F
+ 80 ° C / 176 ° F



MULTI-PURPOSE SCRAPER BLADE - 10" X .24" / GRATTOIR À LAME DE NYLON TOUT-USAGE - 10" X .24"

HAND scraper with NYLON blade, 10" wide. Colour available: white.

FH-A36

MULTI-PURPOSE SCRAPER BLADE - STAINLESS STEEL 10" X .04" / 25 CM / GRATTOIR À LAME D'ACIER INOXYDABLE TOUT-USAGE - 10 X .04" / 25 CM

HAND scraper with STEEL blade, 10" wide. Colour available: white. Grattoir à main avec lame d'acier inoxydable, largeur 10 po. Couleur disponible: blanc

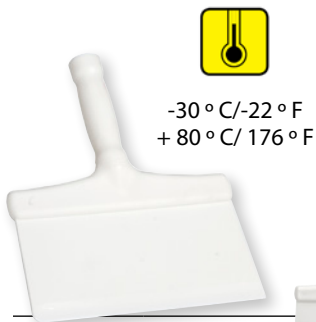

-30 ° C / -22 ° F
+ 80 ° C / 176 ° F



Grattoir à main avec lame de nylon, largeur 10 po. Couleur disponible: blanc



SPECIFY COLOUR WHEN ORDERING
SPÉCIFIER LA COULEUR LORS DE LA COMMANDE



M2 Code Code M2	Description	Pack Wt LB (S) Poids (lb) (S)	Pack Wt KG Poids (kg)	Cubic Ft Pi3	Pack Contenu	List Price Liste des prix
FP-SCR811-WH	Small Hand Scraper 10/bag 3"/ 7.5 cm X 8"/ 20.5cm / Grattoir à main petit 10/sac 3"/ 7.5cm X 8"/ 20.5cm				10/1	\$ 8.38
FP-SCR812-WH	Large Hand Scraper 4"/ 10 cm X 10"/ 25.cm / Grattoir à main large 4"/ 10 cm X 10"/ 25.cm				10/1	\$ 13.72
FP-SCR813-WH	Small Flexi-scraper 6"/ 15 cm X 4"/ 3.82cm/ Grattoir flexible petit 6"/ 15 cm X 4"/ 3.82cm				10/1	\$ 7.75
FP-SCR814-WH	Large Flexi-scraper 9"/ 23 cm X 5"/ 11.8 cm/ Grattoir flexible grand 9"/ 23 cm X 5"/ 11.8 cm				10/1	\$ 10.30
FP-SCR110-WH	Multi-purpose Scraper Blade - Polypropylene 10 x .24 x 12"/ 25 x .6 x 30 cm Grattoir à lame de polypropylène tout-usage 10 x .24 x 12 po/ 25 x .6 x 30 cm				10/1	\$ 46.51
FP-SCR111-WH	Multi-purpose Scraper Blade - Stainless Steel 10 x .24 x 12"/ 25 x .6 x 30 cm Grattoir avec lame en acier inoxydable tout-usage 10 x .24 x 12 po/ 25 x .6 x 30 cm				10/1	\$ 138.44
FP-MB24	MonoBlock Plastic Short Handle 24"/ 60 cm / Dia 1"/ 25mm/ Manche court en plastique monobloc 24"/ 60cm / Dim 1" 25 mm				10/1	\$ 26.24
FP-MB57	MonoBlock Plastic Long Handle 57"/ 145 cm / Dia 1"/ 25 mm/ Manche en plastique long monobloc 57"/ 145 cm / Dim 1"/ 25 mm				10/1	\$ 41.57
FH-A36	Threaded To Locking Collar adapters Adapteur de vissé				12/1	\$ 2.33



SHOVELS / PELLES

STANDARD ONE PIECE SHOVEL 35 CM / 11" BLADE / PELLE UNE PIÈCE STANDARD - 35 CM / 11"

POLYPROPYLENE ONE-PIECE SHOVEL,
Standard size (11 X 14 X 43" / 28 X 35 X 110 cm),
for food industry.

D-shaped hand grip. Pelle une pièce en polypropylène,
taille large (11 X 14 X 43" / 28 X 35 X 110 cm), pour
l'industrie alimentaire, poignée en forme de D

- Fits all HACCP system requirements
- Food contact certificates held
- Rust and rot-proof
- Tough and durable
- Non-stick
- Lightweight and easy to handle
- Virtually unbreakable

LARGE ONE PIECE SHOVEL 35 CM / 14" BLADE / PELLE UNE PIÈCE LARGE - 35 CM / 14" LARGEUR

Polypropylene One-Piece Shovel, Large size
(14 X 16 X 43" / 35 X 40 X 110 cm), for food industry. D-shaped hand grip.

Pelle une pièce en polypropylène, taille standard
(14 X 16 X 43 po / 35 X 40 X 110 cm), pour l'industrie alimentaire, poignée
en forme de D

- Convient à toutes les exigences du système HACCP
- Contact alimentaire certifié tenue
- Antirouille et imputrescible
- Robuste et durable
- Non collante
- Légère et facile à manipuler
- Pratiquement incassable



-30 °C / -22 °F
+ 80 °C / 176 °F

**Please specify colour when ordering
S.v.p. spécifier la couleur au
moment de la commande**

WH = B GN = V BL = BL RD = R YE = J



M2 Code Code M2	Description	Pack Wt LB (S) Poids (lb) (S)	Pack Wt KG Poids (kg)	Cubic Ft Pi3	Pack Contenu	List Price Liste des prix
FP-SH11	Standard One-piece Shovel-Blade Width -11"x 14"x 43" Oval Length (28 cm x 36 cm x 110 cm) Pelle une pièce standard - 11" / 35 cm Largeur de la lame 1.1m / 43" longueur ovale				1	\$ 227.49
FP-SH14	Large One-piece Shovel-Blade Width -14"x 16"x 43" Oval Length (35 cm x 40 cm x 110 cm) Pelle une pièce large - 14" / 35 cm largeur de la lame /43" longueur ovale (35 cm x 40 cm x110 cm)				1	\$ 250.63

PADDLES / AGITATEURS

ONE PIECE PADDLE WITH HOLES / AGITATEUR SIMPLE D'UNE SEULE PIÈCE - AVEC TROUS

Single piece moulding in solid polypropylene suitable for temps - 30°C + 80°C.
Ideal for stirring viscous liquids. Polypropylene One Piece paddle with holes,
(5 x 12 x 46" / 12 x 29 x 119 cm).

Une seule pièce moulée en polypropylène solide, appropriée pour les
températures de - 30 C à + 80 C. Idéale pour l'agitation de liquides visqueux.

Agitateur une pièce en polypropylène avec trous, (5 x 12 x 46 po / 12 x 29 x 119 cm).



ONE PIECE PADDLE WITH WITHOUT HOLES / AGITATEUR SIMPLE D'UNE SEULE PIÈCE - SANS TROU



**Paddle head range is available with an end cap as a hand tool
or with a stainless steel pole with hand grips.**

- Fits all HACCP system requirements
- Food contact certificates held
- Lightweight and easy to handle
- Rot and rust-proof
- Tough and durable
- Non-stick
- Easily cleaned



-30 °C / -22 °F
+ 80 °C / 176 °F

Paddle head available in heat-resistant nylon (Black) with end cap or
with stainless steel pole and PP grips

**La gamme de tête de l'agitateur est disponible avec un embout
comme un outil à main ou avec un manche en acier inoxydable
avec poignée.**

- Convient à toutes les exigences du système HACCP
- Certificats de contact avec les aliments détenus
- Léger et facile à manipuler
- Imputrescible et antirouille
- Robuste et durable
- Non collant
- Facile à nettoyer

La tête de l'agitateur est disponible en nylon résistant à la chaleur (noir)
avec embout ou avec le manche en acier inoxydable et poignée PP.

M2 Code Code M2	Description	Pack Wt LB (S) Poids (lb) (S)	Pack Wt KG Poids (kg)	Cubic Ft Pi3	Pack Contenu	List Price Liste des prix
FP-PD800-WH	Single One Piece Paddle- Ideal for stirring thick viscous liquids with Holes / 46" Overall Length Agitateur simple d'une seule pièce - idéal pour l'agitation de épais liquides visqueux - avec trous - 46" longueur ovale				1	\$ 160.84
FP-PD810-WH	Single One Piece Paddle- Ideal for stirring thin viscous liquids No Holes / 46" Overall Length Agitateur simple d'une seule pièce - idéal pour l'agitation de épais liquides visqueux - sans trou - 46" longueur ovale				1	\$ 160.84

ICE BUCKETS, TOTES & DRAIN BOX / SEAU À GLACE, BACS UTILITAIRES ET BACS PERFORÉS



10 GALLON ICE BUCKET 10 GALLONS SEAU À GLACE

- Ergonomic handle for easy gripping and reduced slippage
- Countour lid for tote on tote stacking
- Ice only logo printed on front
- Weight: 2.25 lbs / 1 kg
- Poignées ergonomiques pour une prise facile et réduire le glissement.
- Contour de couvercle pour faciliter l'empilement.
- Logo "Glace seulement" imprimé sur le devant.
- Poids: 2.25 lbs / 1 kg

← 17.25" / 44 cm →



10 GALLON ICE BUCKET LID 10 COUVERCLE DE SEAU À GLACE

- Ergonomic handle for easy gripping and reduced slippage
- Countour lid for tote on tote stacking
- Weight: .64 lbs / .3 kg
- Poignées ergonomiques pour une prise facile et réduire le glissement.
- Contour de couvercle pour faciliter l'empilement.
- Poids: 0.64 lb / 0,3 kg



4" / 10 CM BUS CUTLERY TOTE 4 PO/ 10 CM BUS BOX COUVERTS FOURRE-TOUT



5" / 13 CM BUS TOTE 5 PO/ 13 CM BOÎTE BUS FOURRE-TOUT



7" / 18 CM BUS TOTE 7 PO/ 18 CM BOÎTE BUS FOURRE-TOUT



5" / 13 CM BUS TOTE LID 5 PO/ 13 CM BOÎTE BUS FOURRE-TOUT COUVERCLE



DRAIN BOX KIT INC. / L'ENSEMBLE DE BACS UTILITAIRES PERFORÉS INCLUS:

- 54 holes for fast easy draining / • 54 trous pour un drainage facile
- 1 - 21.25 x 11.25 x 7" / 54 x 29 x 18 cm - Bus Box / bac utilitaire
- 1 - 21.25 x 17.25 x 5" / 54 x 44 x 13 cm - Perforated Bus Box / bac utilitaire
- 1 - 21.25 x 11.25 x 1.5" / 54 x 29 x 4 cm Bus Box Lid - couvert de bac utilitaire



BUS BOX BAC UTILITAIRE



PERFORATED BUS BOX BAC UTILITAIRE PERFORÉ



BUS BOX LID COUVERT DE BAC UTILITAIRE



M2 Code Code M2	Description	Pack Wt LB (S) Poids (lb) (S)	Pack Wt KG Poids (kg)	Cubic Ft Pi3	Pack Contenu	List Price Liste des prix
ICE BUCKETS / SEAU A GLACE						
WM-PR1010-WH	10 / 38 L Gallon Ice bucket - White / 10 gal / 38 L seau à glace - blanc				6/1	\$ 43.31
WM-PR1010-WH-L	10 Gallon Ice Bucket Lid - White / 10 gallons couvercle de seau à glace - blanc				6/1	\$ 26.27
PP-7210	Plastic Pail Lid Opener / Ouvre-couvercle de seau en plastique				12/1	\$ 10.95
BUS BOX TOTES / BUS FOURRE-TOUT						
BB-4000	4" Bus Box Cutlery Tote -13"x 21.5"x 4"H / 45 x 55 x 10 cm - Grey / 4" Bac à coutellerie 13"x 21"x 4" / 45 x 55 x 10 cm - gris				4/1	\$ 23.38
BB-5000	5" Bus Box Tote -17.25" x 21.25" x 5" H / 45 x 55 x 13 cm - Grey / 5" Bac fourre-tout 17.25 x 21.25 . 5" / 45 x 55 x 13 cm - gris				4/1	\$ 22.00
BB-5001	5" Bus Box Tote Lid -17.25" x 21.25" x 5" H / 45 x 55 x 13 cm - Grey / 5" Bac fourre-tout Couvercle 17.25 x 21.25 . 5" / 45 x 55 x 13 cm - gris				12/1	\$ 26.46
BB-7000	7" Bus Box Tote -17.25" x 21.25" x 7" H / 45 x 55 x 18 cm - Grey / 7" Bac fourre-tout 17.25" x 21.25" x 7" / 45 x 55 x 18 cm - gris				4/1	\$ 22.35
BB-7050	7" X 5" / 18 x 13 cm Drain Box Kit Including Lid - White / 7" x 5" / 18 x 13 cm bac utilitaire perforé - blanc				1	\$ 87.33



M2 CLEANING CENTRE DISPLAY / ÉTALAGE CENTRE DE NETTOYAGE M2



M2 Code Code M2	Description	Pack Contenu	List Price Liste des prix
CC-90001	M2 Cleaning Centre Box - 32" x 25" x 22" / 81 x 63 x 56 cm / Boîte centre de nettoyage - 32 x 25 x 22 po / 81 x 63 x 56 cm	1	\$ 55.23
CC-90002	M2 Cleaning Centre Barrel - 24" x 78" / 56 x 96 cm / Baril centre de nettoyage - 24 x 78 po / 56 x 96 cm	1	\$ 79.69



CC-90010	Telescopic pole holder base / Support de arche télescopique	1	\$ 264.25
CC-90003	Metal Broom Display	1	\$ 471.53

MISCELLANEOUS PRODUCTS / PRODUITS DIVERS



M2 Code Code M2	Description	Pack Wt LB (S) Poids (lb) (S)	Pack Wt KG Poids (kg)	Cubic Ft Pi3	Pack Contenu	List Price Liste des prix
TM-600	Garden Ties / Tomato Ties / Attaches de jardin / Attaches de tomates				12	\$ 19.37
CC-AC94000	Universal Slot Wall & Peg Board Double Hook / Crochet double avec attache universel pour mur et tableau d'affichage					\$ 19.27

Index

A

AR-AP9204	93
AR-FU9202	93
AR-GL9200	93
AR-OA9206	93
AR-OV9205	93
AR-ST9203	93

B

BA-3000	29
BA-3001	29
BA-3036	23, 28
BA-3036-HO	28
BA-3200	27
BA-3200-1W	27
BA-3220	27
BA-3250	27
BA-3250-2	27
BA-8306-BK	29
BA-8306BK-48	29
BA-8306-BL	29
BA-8306-GN	29
BA-8306-RD	29
BA-8306-YE	29
BA-9700	28
BA-9700-D	28
BA-9700-HO	28
BA-9700-RD	28
BA-9708	28
BA-9708-D	28
BA-9708-HO	28
BA-9708-RD	28
BA-9800	28
BA-9900	28
BB-410	44
BB-3615	33
BB-4000	137
BB-5000	137
BB-5001	137
BB-7000	137
BB-7050	137
BBC-206GP	35
BBC-206M	35
BBC-206SF	35
BBC-206T	35
BBQ-1200	133

BBQ-1202	133
BBQ-1203	133
BBQ-W2200	133
BBQ-W2201	133
BBQ-W2202	133
BC-101	30
BC-102	30
BC-103	30
BC-104	30
BC-107	30
BC-107C	30
BC-108	30
BC-110	30
BC-500	30
BCA-226WT	31
BCA-228P	31
BCA-228WT	31
BCT-7818	125
BD-224UN	33
BD-226BA	31
BD-226BA-2	31
BD-226PL	31
BD-1110	32
BD-1110-M54	32
BD-1508	32
BD-1508-348W	32
BD-1608	32
BD-1610	32
BD-BD1601	31
BD-BD1705	31
BH-229PL	32
BH-229WT	32
BK-207L	36
BK-397L	36
BK-KW2027	36
BK-KW2027-GN	36
BK-KW2027-GY	36
BK-KW2028	36
BK-KW2029	36
BM-4100	27
BM-4200-BL	26
BM-4200-RD	26
BM-4200-W	26
BM-4250-BK	26
BM-4250-BL	26
BM-4250-RD	26
BM-4260	26
BM-4260-HO	26

BM-4261	26
BM-4270	26
BM-4300-BL	26
BM-4300-RD	26
BM-4320	26
BM-4400	25
BM-4400BK	25
BM-4400-HO	25
BM-4400-HO-RD	25
BM-4410	25
BM-4420	25
BM-4500	27
BM-4500-BL	27
BM-4500-HO-BK	25
BM-4600-BL	27
BR-CO206D	24
BRP-210BFL	35
BRP-210BFS	35
BRP-210UNL	35
BRP-210WHT	35
BRP-210WL	35
BRP-210WL-BL	125
BRP-210WL-GFS	35
BRP-210WL-GN	125
BRP-210WL-RD	125
BRP-210WL-WH	125
BRP-210WL-YE	125
BRP-210WS	35
BRP-210WS-BL	125
BRP-210WS-GFS	35
BRP-210WS-GN	125
BRP-210WS-RD	125
BRP-210WS-WH	125
BRP-210WS-YE	125
BR-SC229	37
BR-SC231	37
BR-TR1253	31
BR-UT60306	37
BR-UT60702	34
BR-UT60709	34
BR-WM202	94
BR-WM203	94
BR-WM203-C	94
BR-WM204	94
BR-WM214	95
BT-112	29
BT-112-NC	29
BT-113	29

BT-115	29
BV-298WH	33
BV-300AR	33
BV-300F	33
BV-301F	33
BV-400	34
BV-400-BL	34
BV-400-GN	34
BV-400-RD	34
BV-400-WH	34
BV-400-YE	34
BV-420	34
BV-421	34
BV-3205	32
BW-205SFR	33
BW-205WT	33
BW-205WTR	33
BW-1037	36
BW-1038	36
BW-1039	36
BW-AC3310	6
BW-D1232-40 - BL	4
BW-D1232-40 - BR	4
BW-D1232-40 - GY	4
BW-D1232-40 - YE	4
BW-D1232-BL	6
BW-D1232-BN	6
BW-D1232-GY	6
BW-D1232-YE	6
BW-D2632 - BL	5
BW-D2632 - BR	5
BW-D2632 - GY	5
BW-D2632 - YE	5
BW-D2633 - BL	4
BW-D2633 - BR	4
BW-D2633 - GY	4
BW-D2633 - YE	4
BW-D2640 - BL	5
BW-D2640 - BR	5
BW-D2640 - GY	5
BW-D2640 - YE	5
BW-D33101-BL	6
BW-D33101-GN	6
BW-D33101-GY	6
BW-D33101-RD	6
BW-D33101-YE	6
BW-D41102 - BL	5
BW-D41102 - GN	5



FS-8211-BL	101	HW-160W	77	MC-583-YE	99	MFP-V4218-RD	112
FS-8211-RD	101	HW-1254W	77	MC-600-BL	99	MFP-V4218-YE	112
FS-8211-WH	101	HW-7000F	76	MC-601-GN	99	MFP-V4224-BL	112
FS-9224-YE	88, 101	HW-7000F-FD	76	MC-602-RD	99	MFP-V4224-GN	112
FS-C524	54	HW-7000F-GN	76	MC-603-YE	99	MFP-V4224-RD	112
FS-C536	54	HW-7000F-OR	76	MC-620-BL	99	MFP-V4224-YE	112
FS-M18	53	HW-7000F-RD	76	MC-621-GN	99	MFP-V4236-BL	112
FS-M22	53	HW-7000F-WH	76	MC-622-RD	99	MFP-V4236-GN	112
FS-M622	53	HW-7000F-YE	76	MC-623-YE	99	MFP-V4236-RD	112
FS-MB220-WH	124	HW-7001F	76	MC-700	99	MFP-V4236-YE	112
FS-MB224-BL	51, 124	HW-7002W	77	MC-700BL	100	MFP-V4310	111
FS-MB224-GN	51, 124	HW-7003A	77	MFF-7410	113	MFP-V4316	111
FS-MB224-RD	51, 124	HW-7003M	77	MFF-7416	113	MFP-V4318	111
FS-MB224-WH	51, 124	HW-7004A-TEL	77	MFF-7418	113	MFP-V4324	111
FS-MB224-YE	51, 124	HW-8054F-BL	77	MFF-7424	113	MFP-V4336	111
FS-MH18	53	HW-8060F-BL	77	MFF-7436	113	MFP-V5210-GY	111
FS-MH22	53	HW-8160-M	77	MFK-V7418-Kit	114	MFP-V5216-GY	111, 116
FS-MH22-RD	53	HW-9054F-BL	77	MFK-V50018	114	MFP-V5218-GY	111
FS-MH30	53	HW-9060F-BL	77	MFK-V60016	114	MFP-V5224-GY	111
FS-MH30-RD	53	HW-9160-M	77	MFK-V70016	115	MFP-V5236-GY	111
FS-MP10-WH	105	HW-PC-80016	72	MFK-V80016	114	MW-BM16	71
FS-MP18-YE	51	HW-PC-80016C	72	MFK-V90018	115	MW-BM20	71
FS-MP24-BL	51	HW-PC-80020	72	MFP-4010-BL	86, 110	MW-BM24	71
FS-MP24-GN	51	HW-PC-80020C	72	MFP-4018-BL	110	MW-CC12	66
FS-MP24-RD	51	HW-PC-80024	72	MFP-4018-GN	110	MW-CC12B	67
FS-MP24-WH	51	HW-PC-80024C	72	MFP-4018-RD	110	MW-CC12WB	66
FS-MP24-YE	51	HW-PC-90020	72	MFP-4018-YE	110	MW-CC12WBB	67
FS-MP30-WH	51			MFP-4024-BL	110	MW-CC16	66
FS-MPS18	52	L		MFP-4036-BL	110	MW-CC16#	68
FS-MPS22	52	LS-1171	24	MFP-5010-BL	98	MW-CC16B	67
FS-P4518	52	LS-1172	24	MFP-5012-BL	98	MW-CC16B#	68
FS-P5522	52	LS-1173	24	MFP-5018-BL	98	MW-CC16FTB	67
FS-P7530	52	LS-2100	24	MFP-5018-GN	98	MW-CC16WB	66
FS-S18R	54	M		MFP-5018-RD	98	MW-CC16WBB	67
FS-S24R	54	MC-500-BL	99	MFP-5518	110	MW-CC16WBB#	68
FS-S518	54	MC-501-GN	99	MFP-5524	110	MW-CC20	66
FS-S524	54	MC-501GN	99	MFP-5536	110	MW-CC20#	68
FS-S524-54	54	MC-502-RD	99	MFP-6018-GY	98	MW-CC20B	67
FS-S530	54	MC-503-YE	99	MFP-V4210-BL	112	MW-CC20B#	68
FS-S536	54	MC-504-OR	99	MFP-V4210-GN	112	MW-CC20FTB	67
H		MC-520-BL	99	MFP-V4210-RD	112	MW-CC20WB	66
HC-2900	125	MC-521-GN	99	MFP-V4210-YE	112	MW-CC20WBB	67
HW-145M	77	MC-522-RD	99	MFP-V4216-BL	112, 116	MW-CC20WBB#	68
HW-145W	77	MC-523-YE	99	MFP-V4216-GN	112	MW-CC24	66
HW-160A	77	MC-580-BL	99	MFP-V4216-RD	112	MW-CC24#	68
HW-160F	77	MC-581-GN	99	MFP-V4216-YE	112	MW-CC24B	67
HW-160M	77	MC-582-RD	99	MFP-V4218-BL	112	MW-CC24B#	68
				MFP-V4218-GN	112	MW-CC24FTB	67

MW-CC24WB	66	MW-MPEC12	62	MW-SL3L-NB	65	MW-SW3L-NB-BL	57
MW-CC24WBB	67	MW-MPEC12-WB	62	MW-SL4XL-NB	65	MW-SW3L-NB-GN	58
MW-CC24WBB#	68	MW-MPEC16	62	MW-SL10S-WB	65	MW-SW3L-NB-OR	58
MW-CC32	66	MW-MPEC16-WB	62	MW-SL11M-WB	65	MW-SW4XL-NB-BL	57
MW-CC32#	68	MW-MPEC20	62	MW-SL12L-WB	65	MW-SW4XL-NB-GN	58
MW-CC32B	67	MW-MPEC20-WB	62	MW-SL13XL-WB	65	MW-SW4XL-NB-OR	58
MW-CC32B#	68	MW-MPEC24	62	MW-SLR1S-NB-BL	55	MW-SW10S-WB-BL	57
MW-CC32FTB	67	MW-MPEC24-WB	62	MW-SLR1S-NB-GN	55	MW-SW10S-WB-GN	58
MW-CC32WB	66	MW-MPEC32	62	MW-SLR1S-NB-OR	55	MW-SW10S-WB-OR	58
MW-CC32WBB	67	MW-MPEC32-WB	62	MW-SLR1S-NB-WH	55	MW-SW11M-WB-BL	57
MW-CC32WBB#	68	MW-RF2090	71	MW-SLR2M-NB-BL	55	MW-SW11M-WB-GN	58
MW-CL1S-NB	67	MW-SC12	63	MW-SLR2M-NB-GN	55	MW-SW11M-WB-OR	58
MW-CL2M-NB	67	MW-SC12B	64	MW-SLR2M-NB-OR	55	MW-SW12L-WB-BL	57
MW-CL3L-NB	67	MW-SC12FTB	65	MW-SLR2M-NB-WH	55	MW-SW12L-WB-GN	58
MW-CL4XL-NB	67	MW-SC12WBB	64	MW-SLR3L-NB-BL	55	MW-SW12L-WB-OR	58
MW-CL10S-WB	67	MW-SC16	63	MW-SLR3L-NB-GN	55	MW-SW12-NB-BL	59
MW-CL11M-WB	67	MW-SC16B	64	MW-SLR3L-NB-OR	55	MW-SW12-WB-BL	59
MW-CL12L-WB	67	MW-SC16B#	64	MW-SLR3L-NB-WH	55	MW-SW13XL-WB-BL	57
MW-CL13XL-WB	67	MW-SC16FTB	65	MW-SLR4XL-NB-BL	55	MW-SW13XL-WB-GN	58
MW-CS16	70	MW-SC16WB	63	MW-SLR4XL-NB-GN	55	MW-SW13XL-WB-OR	58
MW-CS20	70	MW-SC16WBB	64	MW-SLR4XL-NB-OR	55	MW-SW16-NB-BL	59
MW-CS24	70	MW-SC16WBB#	64	MW-SLR4XL-NB-WH	55	MW-SW16-WB-BL	59
MW-HS16B	70	MW-SC20	63	MW-SLR09XS-NB-BL	55	MW-SW20-NB-BL	59
MW-HS20B	70	MW-SC20B	64	MW-SLR09XS-WB-BL	56	MW-SW20-WB-BL	59
MW-HS24B	70	MW-SC20B#	64	MW-SLR10S-WB-BL	56	MW-SW24-NB-BL	59
MW-LFB16BB	70	MW-SC20FTB	65	MW-SLR10S-WB-GN	56	MW-SW24-WB-BL	59
MW-LFB20BB	70	MW-SC20WB	63	MW-SLR10S-WB-OR	56	MW-SW32-NB-BL	59
MW-LFB24BB	70	MW-SC20WBB	64	MW-SLR10S-WB-WH	56	MW-SW32-WB-BL	59
MW-LFC16B	69	MW-SC20WBB#	64	MW-SLR11M-WB-BL	56	MW-SWC12-BL	60
MW-LFC20B	69	MW-SC24	63	MW-SLR11M-WB-GN	56	MW-SWC16-BL	60
MW-LFC24B	69	MW-SC24B	64	MW-SLR11M-WB-OR	56	MW-SWC16-GN	60
MW-LFR16B	69	MW-SC24B#	64	MW-SLR11M-WB-WH	56	MW-SWC16-OR	60
MW-LFR20B	69	MW-SC24FTB	65	MW-SLR12L-WB-BL	56	MW-SWC20-BL	60
MW-LFR24B	69	MW-SC24WB	63	MW-SLR12L-WB-GN	56	MW-SWC20-GN	60
MW-MM16-BL	72	MW-SC24WBB	64	MW-SLR12L-WB-OR	56	MW-SWC20-OR	60
MW-MM20-BL	72	MW-SC24WBB#	64	MW-SLR12L-WB-WH	56	MW-SWC24-BL	60
MW-MM20-RD	72	MW-SC28	63	MW-SLR13XL-WB-BL	56	MW-SWC24-GN	60
MW-MM24-BL	72	MW-SC28B	64	MW-SLR13XL-WB-GN	56	MW-SWC24-OR	60
MW-MM24-RD	72	MW-SC28WBB	64	MW-SLR13XL-WB-OR	56	MW-SWC28-BL	60
MW-MM32-BL	72	MW-SC32	63	MW-SLR13XL-WB-WH	56	MW-SWC28-GN	60
MW-MPE1S-NB	62	MW-SC32B	64	MW-SS11920	71	MW-SWC28-OR	60
MW-MPE2M-NB	62	MW-SC32B#	64	MW-SS11924	71	MW-SWC32-BL	60
MW-MPE3L-NB	62	MW-SC32FTB	65	MW-SW1S-NB-BL	57	MW-SWC32-GN	60
MW-MPE4XL-NB	62	MW-SC32WB	63	MW-SW1S-NB-GN	58	MW-SWC32-OR	60
MW-MPE10S-WB	62	MW-SC32WBB	64	MW-SW1S-NB-OR	58	MW-TM396	71
MW-MPE11M-WB	62	MW-SC32WBB#	64	MW-SW2M-NB-BL	57	MW-TM600	71
MW-MPE12L-WB	62	MW-SL1S-NB	65	MW-SW2M-NB-GN	58	MW-VCC12B	69
MW-MPE13XL-WB	62	MW-SL2M-NB	65	MW-SW2M-NB-OR	58	MW-VCC16B	69



MW-VCC20B	69	PB-600-BT24	39	PB-BD700-GB18	41	PB-PE14	46
MW-VCC24B	69	PB-610-T18	39	PB-BD700-GB24	41	PB-PE18	46
MW-VCC32B	69	PB-610-T24	39	PB-BD700-GB36	41	PB-PE24	46
MW-VEC12B-CA	69	PB-620-G18	39	PB-BD701-GB18	42	PB-PE36	46
MW-VEC16B	69	PB-620-G24	39	PB-BD701-GB24	42	PB-RB14	46
MW-VEC16B-BL	68	PB-630-BB18	39	PB-BD701-GB36	42	PB-RB18	46
MW-VEC16B-CA	69	PB-630-BB24	39	PB-BD701-RB18	42	PB-RB24	46
MW-VEC20B	69	PB-700-BB18	40	PB-BD701-RB24	42	PB-RB36	46
MW-VEC20B-BL	68	PB-700-BB24	40	PB-BD701-RB36	42	PB-SQB9824	44
MW-VEC20B-CA	69	PB-700-BB36	40	PB-BD800-RB18	41	PB-ST14	47
MW-VEC24B	69	PB-700-BKT	44	PB-BD800-RB24	41	PB-ST14-54T	47
MW-VEC24B-BL	68	PB-700-BKT-60	44	PB-BD800-RB36	41	PB-ST16	47
MW-VEC24B-CA	69	PB-700-GB18	40	PB-BD801-BT18	42	PB-ST16-54T	47
MW-VEC32B-BL	68	PB-700-GB18-UNA	41	PB-BD801-BT24	42	PB-T14	45
MW-VECE32B	69	PB-700-GB24	40	PB-BD801-BT36	42	PB-T18	45
MW-VECE32B-CA	69	PB-700-GB24-UNA	41	PB-BD900-GB18	41	PB-T24	45
MW-VEL16-NB-BL	68	PB-700-RB18	40	PB-BD900-GB24	41	PB-T36	45
MW-VEL20-NB-BL	68	PB-700-RB24	40	PB-BD900-GB36	41	PP-7210	137
MW-VEL24 -NB-BL	68	PB-700-RB36	40	PB-BF18	47		
MW-W16	70	PB-700-ST14	47	PB-BF24	47	Q	
MW-W20	70	PB-700-ST16	47	PB-BF36	47	QM-7580	98
MW-W24	70	PB-701-BB18-HO	43	PB-BT14	45	QM-7581	98
MW-W32	70	PB-701-BB24-HO	43	PB-BT18	45	QM-7582	98
		PB-701-GB18-HO	43	PB-BT24	45	QM-7583	98
		PB-701-GB24-HO	43	PB-BT36	45	QM-7680	98
		PB-701-OR18-HO	43	PB-FS18-BK	123	QM-7681	98
OD-A909	97	PB-701-OR24-HO	43	PB-FS18-BL	123	QM-7682	98
		PB-701-RB18-HO	43	PB-FS18-GN	123	QM-7683	98
		PB-701-RT24-HO	43	PB-FS18-RD	123	QM-8580	100
		PB-720-OR18	40	PB-FS18-WH	123		
		PB-720-OR24	40	PB-FS18-YE	123	R	
		PB-720-OR36	40	PB-FS24-BK	123	RT-BB-9234	37
		PB-720-OR48	40	PB-FS24-BL	123	RT-CB-9318	37
		PB-800-BB18	40	PB-FS24-GN	123	RT-DB-9185	37
		PB-800-BB24	40	PB-FS24-RD	123	RT-DB-9338	28
		PB-800-RB18	40	PB-FS24-WH	123	RT-DM-9217	37
		PB-800-RB24	40	PB-FS24-YE	123	RT-FB-9235	37
		PB-800-RB36	40	PB-G14	46	RT-FM-9250	115
		PB-800-RB48	40	PB-G18	46	RT-FM-9251	115
		PB-801-RB18-HO	43	PB-G24	46	RT-GB-9196	37
		PB-801-RB24-HO	43	PB-G36	46	RT-IB-9307	37
		PB-801-RB36-HO	43	PB-HB18	47	RT-MB-9237	25
		PB-801-RB48-HO	43	PB-HB24	47	RT-NB-9319	37
		PB-810-BT18	40	PB-HB36	47	RT-PL-9326	95
		PB-810-BT24	40	PB-M14	45	RT-SB9175	37
		PB-811--BT18-HO	43	PB-M18	45	RT-SD-9174	37
		PB-811--BT24-HO	43	PB-M24	45	RT-TB-9310	95
		PB-811--BT36-HO	43	PB-M36	45	RT-TB-9311	95
		PB-BD700-60	31, 48			RT-TB-9313	95

WM-PRH4444-L-WH	17	WS-RU42	104	WS-TP104	108	YM-Y310	74
WM-PRH4444-L-YE	17	WS-SC1	108	WS-WS10	106	YM-Y310-M348	74
WM-PRH4444-RD	16	WS-SC2	108	WS-WS14	106	YM-Y312	74
WM-PRH4444-WH	16	WS-SC2-1	108	WS-WS18	106	YM-Y412	71
WM-PRH4444-YE	16	WS-SC2-2	108	WS-WS22	106	YM-Y412-M348	71
WM-PRH5555-GY	16	WS-SC4	109	WS-WSAB14	106	YM-YEC-11140	73
WM-PRH5555-L-WH	17	WS-SC48	109	WS-WSAB18	106	YM-YEC-11140-M48	73
WM-PS008	20	WS-SC205	38, 108	WS-WSEM10	106	YM-YMF-12200	73
WM-PS014	20	WS-SC206	38	WS-WSEM14	106	YM-YMF-12200-M48	73
WM-PS0025	19	WS-SCR001	109	WS-WSEM18	106	YM-YST-05025	73
WM-PS028	20	WS-SCR002	109	WW-940-01	86	YM-YST-050253-M48	73
WM-PS028-BE	20	WS-SCR003	108	WW-940-02	86		
WM-PS028-BL-RYC	20	WS-SCR004	38	WW-1749	86	Z	
WM-PS038	20	WS-SCR005	38	WW-1841	86	ZM-1526	96
WM-PS038-BL-RYC	20	WS-SCR56	109	WW-1849	86		
WM-PS0040	19	WS-SCR56R	109	WW-1850	86		
WM-PS0060	19	WS-SCR1640	109	WW-17411	86		
WM-PS0100	19	WS-SCR1641	109	WW-18411-BL	86		
WM-ST3008	22	WS-SR01510	109	WW-18411-GN	86		
WM-ST4512	22	WS-SR01530	109	WW-18411-RD	86		
WM-ST6818	22	WS-SR01540	109	WW-18411-YE	86		
WM-TW12032	22	WS-SS00	104	WW-18412	86		
WM-TW20855	22	WS-SS12	104				
WM-TW24064	22	WS-SS14	104	Y			
WS-AC003	107	WS-SS18	104	YM8	75		
WS-AC004	107	WS-SS22	104	YM10	75		
WS-AC005	87	WS-SW00	104	YM12	75		
WS-AC006	87	WS-TB10	105	YM16	75		
WS-AC007	105	WS-TB14	105	YM-HY8	75		
WS-BR00	104	WS-TB18	105	YM-HY10	75		
WS-BR01	104	WS-TBP10	105	YM-HY12	75		
WS-BR12	104	WS-TBP14	105	YM-HY16	75		
WS-BR14	104	WS-TBP18	105	YM-HY20	75		
WS-BR18	104	WS-TBS10	105	YM-S8	75		
WS-BR22	104	WS-TBS14	105	YM-S10	75		
WS-CL-15060	107	WS-TBS18	105	YM-S10-54	75		
WS-CL-15061	107	WS-TBS22	105	YM-S12	75		
WS-CS1021-P	107	WS-TP08-2	108	YM-S16	75		
WS-LS9537	24	WS-TP09-3	108	YM-S20	75		
WS-P00	104	WS-TP12-2	108	YM-Y108C	74		
WS-PL12	105	WS-TP16-3	108	YM-Y108C-M348M	74		
WS-PL18	105	WS-TP16-4	108	YM-Y110C	74		
WS-PT200	38	WS-TP20-3	108	YM-Y110C-M348M	74		
WS-PT201	38	WS-TP20-4	108	YM-Y112C	74		
WS-PT202	38	WS-TP30-3	108	YM-Y112C-M348M	74		
WS-RU12	104	WS-TP100-M	108	YM-Y116C	74		
WS-RU14	104	WS-TP100-P	108	YM-Y116C-M348M	74		
WS-RU18	104	WS-TP102	108	YM-Y200	74		
WS-RU22	104	WS-TP103	108	YM-Y212	74		



Distributed by / Distribué par

M2 Professional Cleaning Products Ltd.

59 Talman Court, Concord ON L4K 4L5

T: 905.738.2007 | F: 905.738.2006

Toll Free: 1.844.738.2007

Email: marino@m2mfg.com

M2 Professional Cleaning Products Ltd.

59 Talman Court, Concord (Ontario) L4K 4L5

Tél.: 905.738.2007 | Téléc. : 905.738.2006

Numéro sans frais: 1.844.738.2007

Courriel : marino@m2mfg.com